













157

THE  
NEW YORK

COACH-MAKER'S MAGAZINE,

DEVOTED TO THE  
LITERARY, SOCIAL, AND MECHANICAL INTERESTS OF THE CRAFT.

---

EDITED BY E. M. STRATTON.

---

VOLUME TWO,  
JUNE, 1859, TO MAY, 1860.

---

NEW YORK:  
E. M. STRATTON, Publisher,  
106 ELIZABETH ST.  
LONDON: TRUBNER & CO.

---

MDCCCLX.

TS

2001

N48

MITT/PO

11-02





NOTICE

AFTER CAREFUL EXAMINATION OF THE  
INNER MARGIN AND TYPE OF MATERIAL  
WE HAVE SEWN THIS VOLUME BY HAND  
SO IT CAN BE MORE EASILY OPENED  
AND READ.

TS  
2001  
N48  
MITT/

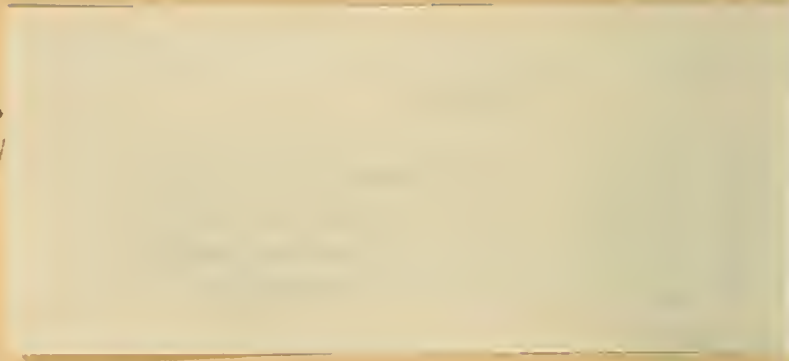

20.5.11



# P R E F A C E .

---

THE Second Volume of THE NEW YORK COACH-MAKER'S MAGAZINE having now been completed, and placed in the hands of its numerous readers, custom would seem to require us of that we give it a preface; not to persuade the public to read it—the principal object of most prefaces—for the presumption is, that has already been done; but to afford the Editor an opportunity for presenting his grateful acknowledgments to his generous and talented correspondents for their efficient assistance during the year; and for thanking the coach-making public for that liberal patronage which has rendered the undertaking a paying one. Our publication having outlived many of its cotemporaries started at the same time, and the difficulties attending every new enterprise of a kindred nature having been surmounted, we feel much satisfaction in being enabled to say that THE NEW YORK COACH-MAKER'S MAGAZINE may now be considered as a fixed fact—a permanent “institution.”

An examination will show that in conducting the work, the labor of the Editor has been to give it a standard value; and that while striving to mingle the agreeable with the useful, he has not forgotten the fact that he was catering for an intelligent and refined community. Under this conviction, everything which might give offense to the fastidious mind, has been carefully excluded. Greater care has been exercised in selecting the drafts for the plates than in the first year; and in variety and interest, it is universally conceded that the reading matter is far more valuable and instructive. We feel that we are justified in the assertion, that for originality and scientific instruction, no work which has yet appeared on the art of Coach-making is equal to it, although sold for double the price. In truth, there is no other country where an Editor would *dare* to tell his readers so much, which is of a practical nature. We have every reason to believe—having already the manuscript in hand—that our third volume will be still more valuable; and now with a few pertinent remarks, permit us in a nautical figure to conclude.

The first volume of this work was commenced with less than one hundred and fifty subscribers, with the injurious effects upon the community of another's defalcations, and the “hard times” to battle with. These have now all been overcome, and the prospect is, that our third voyage will be over smoother seas. With the inducements we offer—low rates of passage, good fare (properly inspected), and an agreeable crew, we feel persuaded that the companions of this “trip” will secure every berth (volume) we shall be able to provide for their accommodation. Under these convictions, we shall “lay in” an extra stock of “food for the mind,” that none may find occasion to charge us with having put them on a “short allowance,” through any neglect on our part. Trusting that we shall have the continued smiles of the craft upon our efforts, and promising that we will use our best endeavors to please, we are

Yours faithfully,

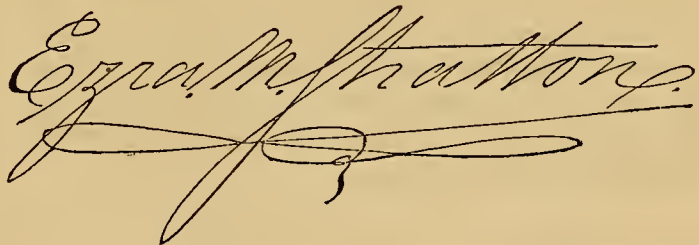

NEW YORK, April 10th, 1860.

## MISCELLANEOUS BUSINESS NOTICES.

**BOUND VOLS. OF THIS MAGAZINE.**—We have had bound up in muslin, gilt, a few sets of this work, which we will sell at the office for six dollars (by mail, postage paid, or express, for \$6 50), or either volume separate for three dollars and fifty cents. Vols. I. and II. embrace about three hundred and fifty illustrations (eighty of them original designs for carriages; twenty-four ornaments for painting; eight stitching plates, and four portraits), and four hundred and seventy-five pages of letter-press matter of a standard character in almost every department of the Coach-maker's Art; most of it never before published. The work will be sent by express to order, price payable on delivery, where persons receiving it are willing to pay the costs of collecting the bills, in addition to that charged for the volumes.

Subscribers can have their numbers bound at this office for 75 cents in our uniform binding. Covers for the same can also be had (they cannot be sent by mail) for 44 cents, in which any binder can secure your *Magazines* uniform with those we sell, for a small sum. Where a club (or several subscribers in a place) will send their numbers by express to us, they will find that a convenient and saving operation for them.

**THE MAGAZINE IN NUMBERS.**—Those who have lost any part of their numbers can have their sets completed at 27 cents each (by mail, in stamps), or at the office at 25 cents. When we are called on to send a *specimen copy*, we expect to receive its value before it can be sent, and should the individual afterwards subscribe, the amount paid will be deducted. Our work differs from the ordinary class of publications in value, and since nine out of ten who *beg* for these "specimens," only have the curiosity to see the work, with no serious intentions of subscribing, we pronounce the game about "played out," now.

**THE USEFULNESS OF THIS WORK.**—There can no longer be any question raised as to the usefulness of such a *Magazine* as ours. The finest carriage we have seen for a long season, was shown us on our late visit to Philadelphia, and which the manufacturer admitted was built after one of Mr. Irving's original designs. Another evidence of its usefulness may be gathered from the circumstance that many of our Western friends complain that our designs are too fine, and are not fashionable in their section of country. Well, we have always thought that the value of all teaching consists in advancing something *new*. We would suggest (aside) to such as have complained of our advance in fashion, that they get ahead of their neighbors in this respect, and ahead of them in custom, too, by getting up a better class of work. *Good work, of good design*, will always sell the best.

**THE PROFIT IN TAKING THIS WORK.**—How many carriage-trimmers have spent several days in trying to originate something novel in a design for stitching-plates, and yet after all find they have but an indifferent pattern when it is put on their job. For the small sum of *three dollars* we will furnish better designs—enough to supply you for an entire year—of a superior order. The painter will find on our ornamental plates such designs as he may look for in vain anywhere else. Any man who reasons at all, will soon see where his true interest lies, and not hesitate about sending in his subscription at once, and thereby secure a monthly visitor, which should it only *suggest* one new idea to his mind during the year, yet must and will be worth more than three dollars to him.

**THE MAGAZINE AS A PRESENT TO EMPLOYEES.**—Bosses will find that where they have apprentices, our *Magazine* as a present to them, would repay more than fifty per cent. on the outlay it costs them. They will find that (unless the boy is very ungrateful) he will do more work, and do it more cheerfully, too, in consideration of his boss having done so. Try it, and let us know the result. We know of cases where a dealer in carriage trimmings has invested a few dollars in *Magazines* and sent them to his customers (carriage-makers) as presents with advantageous results. No better reminder of their obligations to the donor, could be employed.

**CLUBS FOR THE MAGAZINE.**—Have we not some kind friend, in every shop of the land, who will with pencil and paper, and a *little perseverance*, go through it and get us up a club, and at the same time benefit themselves and us. See what we promise such on the first page of the cover. Do not wait for our agent to visit your shop and then expect him to assist you in what we pay him to do, and then expect to get your copy "*free gratis for nothing*." It "can't be did;" because we cannot afford it. You, at \$2 in a club, only pay us the first costs of production, and were it not for *our* advertising friends, you would not get it at any price, long. Only *voluntary* club agents have any legal claim on us, and such only can claim our preferred rewards.

One of the principal objects in starting this work was, to show to the world that Coach-makers were capable of exhibiting as high a standard of literary merit as any other class of men. We flatter ourselves with the belief that our object has in some measure been crowned with success. Col. Forney (a good witness) of the *Philadelphia Press*, says, in referring to our biography of Mr. Wm. D. Rogers, of that city: "We shall respect the coach-makers more than ever for having such a *Magazine* as this." We could, were it necessary, bring forward the testimony of many other editors to prove our *Magazine* a good one.

HOW TO REMIT MONEY.—Where Eastern money cannot easily be obtained, Southern, Western, and Canadian money will be received at par. Where the sum is large, however, drafts on New York are preferred. For the change, *never* send a higher denomination of stamp than 3 cents, as we have no use for larger ones. It will cost you only 5 cents to *have your money letters registered*, and to do so insures safety. In sending gold coin, be particularly careful to *paste* them securely between two pieces of paper, otherwise they will be liable to shake out and be lost from your letter. It is a very careless way of doing business to merely fasten gold to the letter with wafers; they are sure to get loose before reaching their destination. Lastly, be very careful and prepay the postage on your letter, and direct it in a plain hand to E. M. STRATTON, No. 106 Elizabeth street, New York city.

A WORD TO OUR "REAL GENUINE" FRIENDS.—There are hundreds who are constantly calling upon the coach-making fraternity with their new inventions appertaining to the business, who with a word from the well-wishers to our enterprise—suitably put in—might induce them to advertise with us, and so benefit all parties. Those who will try it shall have our best thanks. See our terms on the cover.

#### LETTER FROM NEW HAVEN.

EDITOR COACH-MAKER'S MAGAZINE:—*Dear Sir.*—In accordance with my former promises to you that while traveling over the dominions of our respected Uncle Sam, I would give you from time to time, my experience as a traveling carriage maker, and the items of interest I might pick up beneficiary to the craft, as well as the little seraps of fun falling in my way, which would amuse, if not instruct the whole brotherhood, (to use a Yankee expression peculiar to the land of steady habits and pumpkin pies,) I take my pen in hand to address you these few lines, it, in my opinion, (*I am a Yankee myself,*) being a libel upon the Yankee character on the part of those who say that the aforesaid Yankees in the good old State of Connecticut, manufacture bass-wood hams, wooden nutmegs, horn-gun-flints, and eight-day elocks which run only long enough for the itinerant merchant to get out of sight of the purchaser.

While in the State of Georgia, where many, very many carriages of Connecticut manufacture are annually consumed, I fell in with an old friend whom I shall here call Mr. Rollin, who is continually traveling for one of the heaviest commission houses in New York, soliciting consignments to them; who after the usual greetings, took me by the arm and told me in a good Yankee dialect, "Now look a-here, Dilks, the first place we must go, is to see S. L. Williams, an old friend of both of us, who is right here in this town, permanently located." Well, to S. L. W. we went, and found him looking well. After the usual congratulations, compliments, &c., my friend Rollin says: "Dilks, Williams here is an ex-carriage foreman, manager and book keeper as you know, from one of the New-Haven houses, and I must tell you a little cir-

cumstane which happened to him after he arrived here in Georgia, which will show you how little earriage-makers know about riding in earriages, even if they make them or superintend the making of them themselves.

"Well," Rollins goes on to say, "Williams and myself not having much to do, and hearing of a scrub race coming off some three miles out of town, negotiated with a livery-stable keeper for a horse and no-top buggy, to tote us (as a negro would say) to the race course; and when some half the distance had been accomplished, we came to the foot of quite a steep hill, at the bottom of which was a drain or sluice-way, running across the road, and covered by a bridge of logs. The contents of the aforesaid drain being composed of the sewerage from a slaughter-house, some half dozen pig-pens, a barn yard, and also from a miniature tan-yard above the road. The aforesaid ingredients constituted a mass of the consistency of tar or molasses, but owing to the age of the bridge and the heavy loaded teams passing over it, the logs had been carried down the muddy stream, and we had to drive through or rather ford it. Our horse being a fast one, and as Rollins says (taking his word for it), being an indifferent horseman, went *rather* strong through the aforesaid mud-hole, and when we reached the abutment of the bridge on the opposite side, we brought up all standing. Having a firm hold of the ribbons, I preserved my equilibrium; but not so my friend Williams. There being no back above the seat to the buggy, Williams turned a complete somerset (emulating the circus performers) backwards, and disappeared under the mud and slush! I pulled up as soon as I could, and turning around, saw my friend picking himself out of the aforesaid compound, covered completely with it, and of one color, viz: a shining black. I, notwithstanding I felt inclined to laugh, with as much of a sympathetic tone as I could command, asked him if he was hurt. Spluttering and blowing the filthy compound from his mouth, and wiping it as best he could from his eyes, he stammered forth. "I'm stumped Rollins, if this ain't an episode in a man's life." We went a round about way into town, and lost the fun and excitement of the race for that day.

After again having reached the good old State of earriage-makers, business called me to its northern frontier, or the line of the State of Massachusetts, where I saw one of the most extraordinary cases of *cousining* that has ever fallen under my observation, while residing in Connecticut, and which I will now attempt to describe. To begin; the carriage-maker with whom I was negotiating, being a young man and married only some three years, pleasantly situated, and having a lovely wife, invited me to make his house my home; and as the hotel in the place was an indifferent one, I gladly accepted his offer. While occupied in the afternoon with my friend P., a tall overgrown specimen of the *genus homo*, entered and said: "How d'ye do," "How do you do, Sir!" says P. (quite a pause.) When P. again addresses him. "Well, Sir, what can I do for you, anything in the carriage way to-day Sir?" "Oh, no," says the stranger, or "cousin" as I will now call him. "I come down to W. to-day to sell a horse, and I thought being as I'd hearn of your wife, I'd come in here and see you and her, and cousin a bit. *Doin'* a great deal of business, ain't you; don't mind me, "I'll make myself to hum." My friend P. says, "You see I am very busy now, my house is just down on the next corner, and if you will step down you will find Mrs. P. at

	PAGE		PAGE		PAGE
<b>PAINT-ROOM :</b>		<b>SPARKS FROM THE ANVIL—Continued.</b>		<b>TRIMMING ROOM :</b>	
Buggy, How to Paint,	93	Axle Setting,	229	Back-lining of a Carriage, Plan for,	173
Carriage-part, How to Paint,	32	Anvil Block and Drill,	170	Boot, Securing to a Body, 13 ; Buggy, 94 ; Salisbury,	173
Crome Yellow, New,	212	Body-loop, Fancy,	229	Carriages, Improvement in Trimming,	12
Designs, Original Ornamental (explanations), 12, 71, 153, 192		Cast Steel, 30, 210 ; How made, 71 ; Improvement in making, 69 ; Manufacture of, 210 ; Explodes in Hardening,	210	Cloth Lace, Stitching,	192
French Pigments,	71	Circle Carriage-part,	31	Cochineal, Cultivation of, in Teneriffe,	193
Gossip for the Paint-Shop, 113, 134, 151, 170, 190,	211	Coal of Western Virginia,	133	Colors, Harmony of, in Lining Carriages,	33
Gum Copal,-	53	Couplings, Shaft,	10	Corduroy, Lining Buggies with,	54
Oil, Drying,	94	Fifth Wheel, Smith's,	31	Cushions, Simple Mode of Securing them to a Seat,	54
Red-Lead Ochre, Substitute for,	11	Fore-carriage, Oxley's Patent,	52	Damask, A Query,	54
Scroll, Ornamental, For Painting,	94	Invention wanted,	151	Folding Lights to Triple Phaeton,	113
Theory, Old Foggy's, Disputed,	172	Iron, Hardening, 70, 151, 210 ; Necessity of Encouraging its Home Production,	51	Gipsy-top, The Bow Socket of,	72
Stimson, Valentine & Co.'s Varnish Establishment,	230	Locking-plate, Davies' Segmental,	229	Harness Blacking, Quick Dying, 54 ; Buckles,	136
Varnish, Black Japan, 94, 113 ; Blistering of, 11 ; Reasons why it Changes by Standing, 112 ; Reasons why it Pits, 11 ; Crawling and Shriveling up of, 53 ; On the Sweating-out of, 71 ; Wearing Body,	112	Iron and Nickel,	133	Lazy-Back, for a Rockaway,	232
Panels, Why they Split,	4	Remedy for a Great Evil,	111	Lining-Nails, The Patent Bas-selain,	114
Patent Office, The United States',	62	Saddle-Clip,	169	Leather Tops, Reviving Polish for,	154
Perch Coupling, Non Suited,	118	Scroll-work for a Coach,	70	Liquid Leather,	173
Phaeton, 209 ; Dog-Cart, 132 ; Triple, 110 ; Sporting,	51	Shifting Rail, That Patent,	87	Means of Fastening Leather on Metal,	174
Physical Perfection, Hints toward (notice of),	37	Shifting-top Buggies,	70	Moss and Hair, Substitute for,	232
Political Jestings,	164	Springs, New Mode of Construction, 133 ; Compensating, 150 ; C, 190 ; Mock,	190	Seat Fall, Pattern for,	213
Printing-Office, Our, in Ashes,	194	Square Corners, New Method of Forming,	190, 229	Stitching, 33 ; Plate, 58 ; Machine for,	154
Public, Something for the, 139 ; To the,	118	Stay-Iron for a Coach, 133 ; For a Dickey-Seat, 210 ; For a Body, 10 ; Design for a Fancy Perch, 10 ; For a Raised Back,	30	Stitching Plates, Explanation of E, for August, 55 ; of F, for October, 94 ; Of G, for Feb., 174 ; Of H, for April, 213 ; Pattern for Oval,	232
Prospectus to the Second Volume, 20 ; To the Third Volume,	236	Steel, Homogeneous, 31 ; Science of making, 10 ; Swells in Hardening, 210 ; Theoretical Constitution of, 170 ; Testing the Quality of,	111	Tops, The Springing of, Prevented,	12
Push-Coach,	179	Tempering Tools,	31	Trimmers, A Word with,	72
Queen Elizabeth's Present of a Coach,	118	Triple Phaeton, Iron-work for,	111	Trimming, Styles in Carriage, 154 ; Designs for, a Prince Albert, 192 ; For Coaches, Bretts, &c., 213 ; Buggy,	72
Rail-Car in Philadelphia, New City,	17	Stage Driver, The,	178	Vegetable Leather,	135
Railways in Egypt,	120	Steam Wagon, 38, 179 ; Carriage,	203	Washer-Cutter for Leather,	72
Ralph Long's Story,	167, 186	Stickemstrong's Safety Harness (comic),	160	Whip-Socket, India Rubber,	114
Right Word in the Right Place,	158	Subscribers, New,	153	Trip to New York City,	204
Rockaway, Boston Jump-Seat, 51 ; Irving's Transpose, 209 ; Light, 189 ; Physicians', 189 ; Six-seated Germantown,	150	Sunny South, Wanderings in the,	5	Turkish Edict,	179
Saber-Cut, Story of,	205, 222	Text with a Comment,	176	United States, Thieves in the,	84
Sentiment, A Beautiful one,	107	Theory and Practice Harmonize,	136	Vanity Fair, Notice of,	193
Shifting Rail, the Excitement, 77 ; That Patent,	87	Times and the Fashions,	39	Visit Abroad, Ten Day's,	73
Sleigh, Portland, 69 ; Cutter,	132	Top-lifter, Original Idea for (comic),	19	Wagon, Peddler's, 110 ; Skeleton,	87
Smoker Tapering off,	38	Towns, Air of,	3	Wagons for Texas,	6
Sociable, Singer's,	36	Track in Different Localities, Difference of,	157	Winds out West,	44
Solitude,	82	Trade in France, Commercial Review of, 157 ; Strikes and their Consequences,	216		
<b>SPARKS FROM THE ANVIL :</b>		Traveling Agent,	97		
Announcement,	226				





THE OVAL HEARSE.— $\frac{1}{2}$  IN. SCALE.  
*Engraved expressly for the New York Coach-Maker's Magazine.—Explained on page 9*



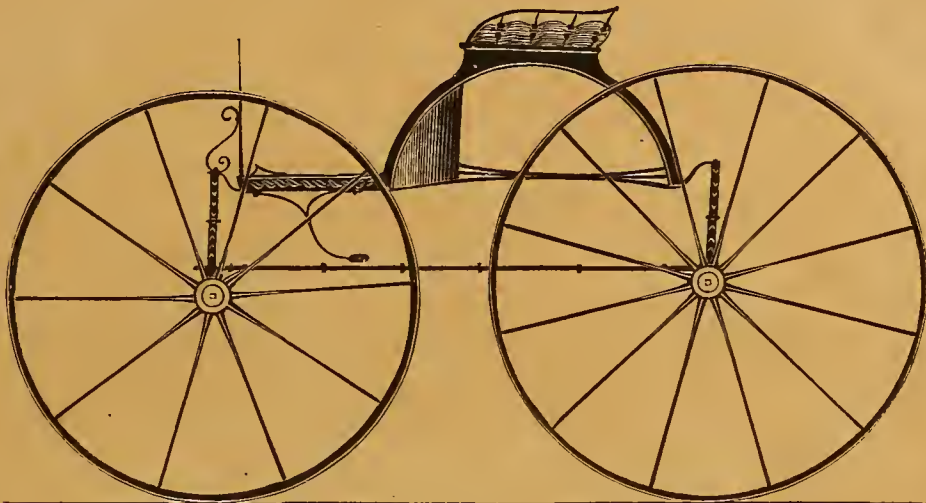

ARCHED BUGGY.— $\frac{1}{2}$  IN. SCALE.

*Engraved expressly for the New York Coach-Maker's Magazine.—Explained on page 9.*



NEWARK BUGGY.— $\frac{1}{2}$  IN. SCALE.

*Engraved expressly for the New York Coach-Maker's Magazine.*

*Explained on page 9.*





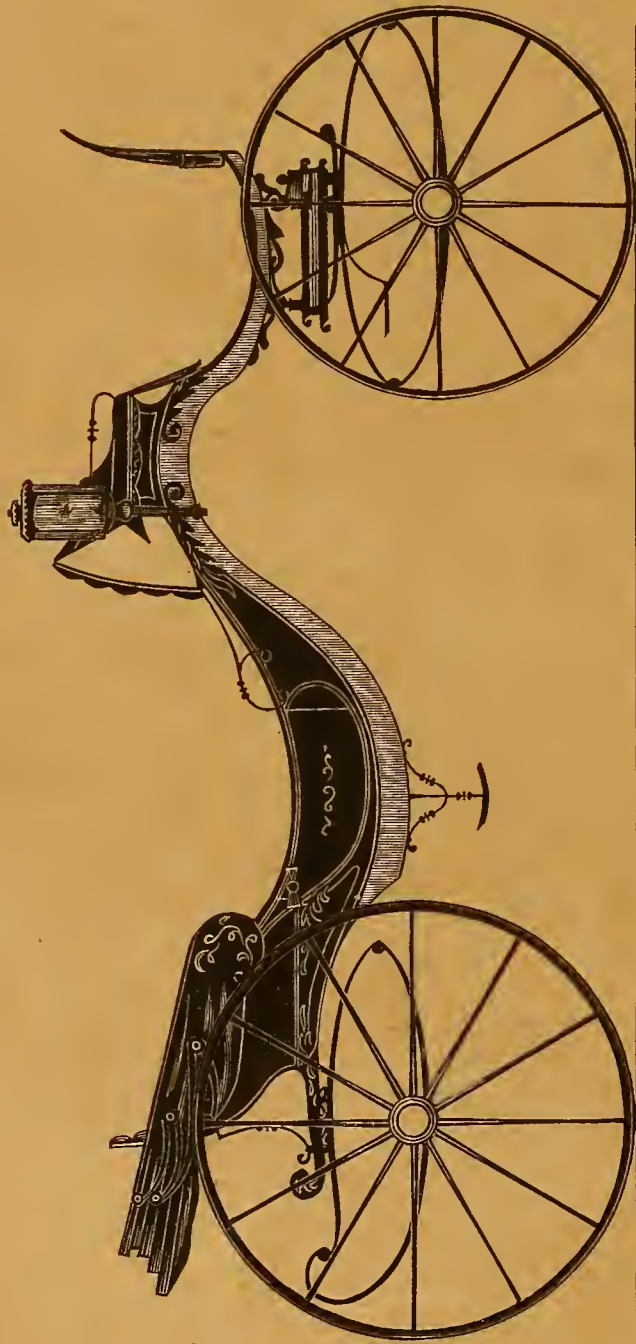

CARDINAL BRETTE.— $\frac{1}{2}$  IN. SCALE.

*Engraved expressly for the New York Coach-Maker's Magazine.—Explained on page 10.*



No. 1.

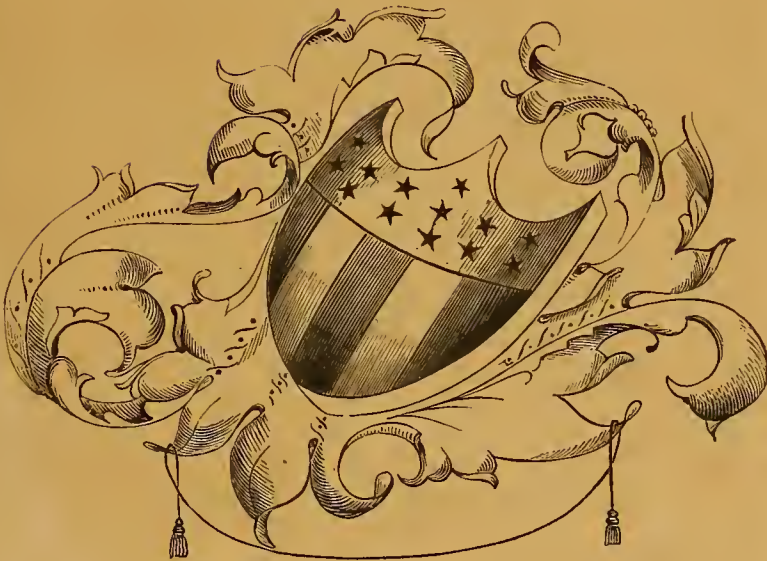

No. 2



No. 3.

ORIGINAL ORNAMENTAL DESIGNS.

*Engraved expressly for the New York Coach-Maker's Magazine.*

*Explained on page 12.*





DEVOTED TO THE LITERARY, SOCIAL AND MECHANICAL INTERESTS OF THE CRAFT.

Vol. II.

NEW YORK, JUNE, 1859.

No. 1.

### Miscellaneous Literature.

For the New York Coach-maker's Magazine.

#### ACTIVITY VERSUS LAZINESS.

"And was there e'er a lazy man  
Who did not prove a liar?  
Most sure, there's not an idle man  
The Devil could not hire."

MANKIND were formed for activity. The nature with which we are all endowed, both physical and mental, furnishes abundant, unequivocal testimony that man was created for some wise and noble end. The simple fact, that man is endowed with faculties, upon the proper exercise of which depend his happiness and well-being, demonstrates, conclusively, that virtuous activity is the lot of mortals, while here below. His physical powers, by inactivity and sloth, become imbecile, effeminate, disorganized and useless. On the contrary, by the proper exercise of these powers, healthfulness and strength appear in the most desirable and perfect manner. Inexhaustible fountains of pleasure and happiness are ever open to those who are accustomed to exercise the faculties which the Creator has given to them, when they have not lost sight of the great end of their existence, and are endeavoring to exercise themselves in a wise, benevolent, and virtuous course of conduct. Energy and activity, exercised either mentally or physically, viciously or virtuously, affords each its appropriate reward. Mental energy and activity urge their possessor in his purposes and efforts to reach the broad and fertile plains "of scientific, living thought on science's hill;" and, by properly contemplating the great facts and truths which the volume of nature discloses to the anxious inquirer after truth and wisdom, the thoughts are elevated, the mind is expanded, and the whole man rendered more reverent, wise and good. Virtuous contemplation, research, and scientific investigation feast and ennoble the mortal powers; but *laziness*, sloth and inactivity, on the contrary, tend to demoralize and to debase all those who are at all inclined to sit down, supinely, without making any effort to be what man *may* be, and what every one *ought* to strive to be. Activity and energy bring not only contentment and happiness, but pecuniary competence; while laziness brings leanness of spirit, the most

wretched penury, and intolerable mendicency. Laziness will not only clothe the body with despicable rags, but it will rob the mind of those pure enjoyments, those ecstatic delights, which involuntarily flow from the proper exercise of the noble faculties of our nature. Every one hates inconsistency and unfaithfulness, and detests dishonesty and unfairness; but a lazy man, or woman, who can bear? We commiserate the disabled, the unfortunate and distressed; we condole with those who are called to endure affliction, and to suffer sore bereavement; and we readily and freely extend our sympathies and commingle our tears with those who, by some melancholy catastrophe, have felt a withering blight fall suddenly upon their fondest hopes and brightest prospects; but, for him who is ever contented to fold his hands in ignoble ease—who will not exercise his faculties—but suffers them to remain dormant, to rust out in abominable laziness, for such an one, we can hardly entertain that "charity which rejoiceth not in iniquity, but rejoiceth in the truth;" and "which believeth all things and hopeth all things." A lazy man is not only a burden to himself, on whom time hangs like a ponderous weight, but he is a nuisance in society, and a libel on the whole human family, and a stigma on the magnificent works of the Almighty, and a reproach to his ancestry. As a vice (if vice it may be called), it is one of the most deplorable curses of the human family.

The tendency of laziness is always downward, while virtuous activity always elevates one in his own, and in the estimation of others. Laziness shuts out everything that is a means of true happiness; and impels its victim along the highway to *ruin*, to *rum*, to the *penitentiary*, and often to the *gallows*. Satan, who is the ostensible author of this curse of the human family, loves a lazy man—

"And Satan finds some mischief still,  
For idle hands to do."

Laziness is incompatible with our physical nature, while activity is the very life and health of all our powers. It does not injure a man, or woman, to work, and to *labor hard, too*, both physically and mentally, when the energies of body and mind are not taxed or exercised beyond their wonted vigor. Instead of being a curse, to visit mankind from generation to generation, the sentence pronounced on the posterity of our great progenitor, "In the sweat of

thy brow shalt thou eat bread," was one of the greatest blessings, in disguise, which ever descended from the Parent of all good. Labor, proper activity and toil, always bring a satisfying and rich reward, while laziness unfits the lazy for everything—pleasure and happiness to himself, and for usefulness to his fellow-creatures, or his benevolent Creator.

It is not denied that mankind all need *rest*. Indeed, cessation from the active duties of life is absolutely necessary, for the health and comfort of all mankind. We are so constituted that we all need rest, and must have it, at its proper time, and to a reasonable extent. But, when we see a young man out of employment, "loafing" about from the public-house to the store, and from thence to the workshop, and to other places of resort, for the purpose of *kill-ing time*, my word and the experience of all wise and active people for it, if he do not mend his ways soon, rum will be his inevitable doom. It is always best for young men to have something to do, some active employment; and every young man, who has half the ambition of a honey bee, or the activity of the little ants, will always try to do something, by which to distinguish himself in the world. It is awfully dangerous to cherish a lazy spirit, because "a lazy man is Satan's workshop;" and who ever knew a proverbially lazy man, who did not redeem himself from the thralldom of laziness before it became too inveterate, that did not come to some miserable end? The wise Author of our existence never implanted this odious vice in the human breast; and all those who wish to be wise, virtuous and good, will shun it as they would the pestilence, and so strive

"To live, that every hour  
May die as dies the natural flower,  
A self-reviving thing of power;  
That every thought and every deed  
May hold within itself the seed  
Of future good and future meed."

LAKE RIDGE, Tompkins Co., N. Y.

S. EDWARDS TODD.

## COACH-MAKING HISTORICALLY CONSIDERED AND INCIDENTALLY ILLUSTRATED.

BY THE EDITOR.

*Continued from Page 225, Volume I.*

### CHAPTER XIII.

A re-capitulation of the history of Coach-making embraced in the twelve chapters published in the first volume—Corvinus, King of Hungary, reported to be the first person to ride in a coach—Introduction of coaches into England—Queen Elizabeth's "Chariot Throne"—Coaches denominated great Hypocrites, by the Water Poet—The cost of a coach in 1573—So numerous as to become a nuisance, in 1605, and employed by all classes of citizens.

[THERE will, undoubtedly, be many readers of this volume who have not seen the first. For the benefit of such, we here add a synopsis of the twelve chapters of the history already published. The first chapter is merely introductory. The second is of a speculative character, in which the sledge—afterwards mounted on wheels—is supposed to have been the prototype of wheel-carriages, and the Egyptians to have been the first inventors. The third is minutely descriptive and illustrative of a chariot-wheel, taken from an Egyptian tomb, and preserved in Dr. Abbott's Museum, in New York city. The fourth is on chariot-making, illustrated by copies of the mode of operating, as given on the monumental remains found in Egypt. The fifth gives a description of the hunting-chariot, the Arabian Plaustrum,

and an Egyptian sledge-hearse, &c. The sixth treats of the Assyrian chariot, giving a particular description of wherein it differs from that of Egypt, copiously illustrated from the recently-exhumed Nimroud sculptures and other remains of art. The seventh presents a poetical view of coach-making, as painted by Homer, Hesiod, and others. The eighth enters fully into the great revolution effected in chariot-making, by the introduction of scythe-chariots by Cyrus, the King of Persia. The inefficiency of scythe-chariots is shown at the battle of Cunaxa, in a contest with Alexander. The ninth describes the use of chariots at the Olympian games, when they gave a character and renown to that ancient institution. Many proofs, in confirmation of that fact, are there given, with examples. The tenth gives a history of the chariot, as employed in Britain at the time of its invasion by Julius Cæsar, with a reference to one seen in the triumphal procession of Caligula, at Rome. The eleventh describes the "horse-litters" of the thirteenth century; and the twelfth the revival of carriage-making in Europe, which is claimed as an invention by no less than four nations in that quarter of the globe. These twelve chapters present a connective and fuller history of the art of coach-making, from an early period of time to the present, than can be found in any other publication extant.]

It is with some reluctance that we feel ourselves obliged to confess that our history of this period is so conflicting, that we find it extremely difficult to separate truth from error. The difficulties are in finding so many versions of the same thing. One author states that coaches were invented at Kotse, in Hungary, from which circumstance the name coach is given, and that Matthias Corvinus, the King of Hungary, was the first person who ever rode in a coach. This, however, is not at all probable, as Corvinus did not reign until the latter half of the fifteenth century. As long ago as the year 1294 there was an edict issued, by Philip le Bel, King of France, prohibiting the use of carriages by the wives of citizens, which goes to show that the Hungarians could not have been more than improvers upon a vehicle already in existence. At this early period, when coaches were prohibited to women, it was also considered disgraceful for men to be seen in them, unless in cases of illness or infirmity.

The entrance of the ambassador Trevasi into Mantua in a carriage, is noticed as early as the year 1433; and that of Frederic III. into Frankfort in a covered coach, in the year 1475. It was almost a hundred years afterwards before covered carriages were introduced into England. Stow, in his "Chronicle" under the date of 1555, has recorded the circumstance in these words: "This yeare Walter Ripon made a coach for the Earle of Rutland, which was the first coach ever made in England. Since, to wit., in anno 1564, the said Walter Ripon made the first hollow-turning coach, with pillars and arches, for her majestie, being then her servant. Also, in anno 1584, a chariot, with foure pillars behind, to beare a canopie with a crowne imperiall on the toppe, and before two lower pillars, whereon stood a lion and a dragon, the supporters of the armes of England." This "chariot throne" was used by Queen Elizabeth in 1588, when she went to St. Paul's Cathedral to return thanks for the deliverance of her kingdom from the Spanish Armada. Previous to 1650 the Queen was accustomed to ride on horseback, behind her Lord Chamberlin, on state occasions. At this time coaches were so rare that all her majesty's attendants accompanied her on horseback.



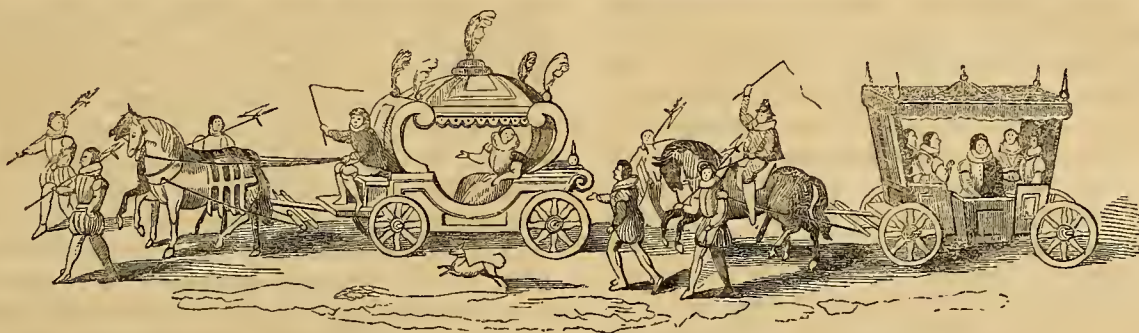

QUEEN ELIZABETH AND HER RETINUE.

Another old writer tells us that in 1564, or about the time that Walter Ripon made the first "hollow-turning coach," "one Guylliam Boonen, a Dutchman, became the Queene's coachmanne, and was the first that brought the use of coaches into England. And after a while, divers great ladies, with as great jealousie of the queene's displeasure, made them coaches and rid in them, up and downe the countries, to the great admiration of the beholders; but then, by little and little, they grew usual among the nobilitée, and others of sort, and within twentie yeares became a great trade of Coachmaking." Added to "the Queene's displeasure" we find that the watermen of the Thames, and the chairmen of London, through "great jealousie," lest their occupations might suffer from the "new inovation," were loud in condemnation of its use in that city. Taylor, the "water-poet," stigmatized the new-fashioned vehicle as a "great hypocrite, for it hath a cover (saith he) for knavery, and curtains to vaile and shadow any wickedness. Besides, like a perpetual cheater, it wears two bootes and no spurs, sometimes having two pair of legs to one boot, and oftentimes (against nature) it makes faire ladies wear the boot; and if you note, they are carried back to back, like people surprised by pyrats, to be tyed in that miserable manner, and thrown overboard into the sea. Moreover, it makes people imitate sea-crabs, in being drawn sideways, as they are when they sit in the boot of the coach; and it is a dangerous kinde of a carriage for the commonwealth, if it be considered."

Another writer, who appears to have been unfavorable to these "great hypocrites," says, that when the Dutchman from the Netherlands presented "the Queene" with a coach she had been already such for seven years, after which period "they increased with a mischief, and ruined all the best housekeeping, to the undoing of the watermen, by the multitude of hackney-coaches."

Coaches and other vehicles had now increased and were in general use. In 1573 we find that private families had their private carriages. There is extant in the household book of the Kyston family (see the Archælogia, Vol. XX.) a memorandum of the cost of a coach, then in use. It reads as follows:—"1573. For my m<sup>tes</sup>. coche, with all the furniture thereto belonging except horses—xxxiiij li. xiiij s. For the painting of my m<sup>r</sup>. and my m<sup>tes</sup>. armes upon the coche—ij s. vj d."

"For ye coche horses bought by Mr. Paxton—xj li. xxii s. iii d."

In 1600, four coaches accompanied an embassy to Morocco, through the city of London; and that of Russia, in the same year, mustered eight. A French mission of congratulation on the accession of James I., three years later, rode in thirty coaches from the Tower-wharf to the Ambassador's dwelling, in Barbican, and returned to their

lodgings, in Bishopsgate-street, in the evening, to the admiration of the citizens.

In 1605 it is stated that coaches swarmed so thick that they pestered the streets, so greatly, "at that time, did the coaches breed and multiply;" in fact, the gunpowder treason and coaches were both classed as "hatched" from the same nest. These new-fashioned "hypocrites" soon became so much the rage that some persons in Parliament moved to bring in a bill to check their too rapid increase, lest the government should be at a loss to mount the army, by reason of the too extensive use of horses in carriages. Those who had been long accustomed to trudge through miry streets, and on horse-back, and had the means, were not long in appropriating the new luxury to their use. If they did not immediately order a coach made, yet they did not fail to hire one when fancy or convenience required it. An old author says that he "heard of a gentlewoman who sent her man to Smithfield from Charing-cross, for the purpose of hiring a coach to carry her to Whitehall. Another did the like from Ludgate-hill, to be carried to see the play at Blackfriars." This desire for coach-riding is attributed to the pride of the people, which, no doubt, was the cause of its being had in such general use. This same author gives us a ludicrous account of the extent the passion for riding in a coach had reached where he tells us that two oyster-women who had hired a coach to carry them to the Green Goose Fair, at Stratford-le-Bow, that, as they hurried along between Aldgate and Mile-end, "they were so de madamed and so de mistressed and ladyfied by the beggars, that the foolish women began to swell with a proud supposition of imaginary greatness, and gave all their money to the mendicanting canters." The rich visitors who came from the country into London at this time were great patronizers of coaches, so that those who kept them for hire must have found profit therein. So universally had these "hypocrites" come into use, that our Water Poet, above alluded to, declares that "butchers cannot pass with their cattle for them; market folks, who bring provisions to the city, are stopped, stayed, and hindered; carts or wains, with their necessary wares, are debarred and letted; the milk-maid's ware is often spilt in the dirt;" and many other charges which it would be tedious to enumerate here.

#### THE AIR OF TOWNS.

IN studying the air of towns in which coals are burnt, no place can give such an opportunity as Manchester, being the largest manufacturing town of the world, and itself being the centre of a great manufacturing district. Geographically, it is not the centre, being near the outskirts of

the district on the southwest side, whilst on every other side manufactures extend for, perhaps, on an average thirty miles. They extend from the south and southeast on the borders of Cheshire and Derbyshire onwards to Preston on the north, Liverpool on the west, and into Yorkshire on the east; and within this district are large towns, little known to fame, but containing a great working population, having, besides wealth, both intelligence and force. In this district, comprehending many hundred square miles, there is every variety of scenery, but I believe every portion of it may be shown to be influenced by the smoke of the workshops. The tinge of darkness in the atmosphere may be seen making a line of at least forty miles in length, and affecting the appearance of the sky and the landscape. At the same time, it is marvelous how rapidly nature asserts her superiority in all this accumulation made by art. The moment we leave a town we see everything greener and fresher, and the people larger, broader, happier and cleaner; and so much so is this the case, that, in the great district of which I have spoken, there is no doubt in the minds of those who are only a little removed from towns, that they are breathing the purest air. Nor is it without difficulty that we can perceive that the towns to some extent affect the whole district. The eye becomes accustomed to the stunted trees and the many withered branches, and broken up hedge-rows; nor is it customary to look at the state of the individual leaves to inquire how far degeneracy has advanced. The eye is sufficiently pleased to see the general aspect of pure green which refreshes us in every portion of the district, for the meadows in spring and summer seldom seem to suffer, but rather to be improved, partly by direct, and partly by indirect, assistance from the towns. In some places, however, the destruction may be called total, the trees that exist being either absolutely dead, or only capable of showing a very feeble life; and this it seems to me is very much the case in proportion to their height, although certain of them, such as the poplar, even if less tall, suffer on account of a greater delicacy. The smoke may either rise or fall or move horizontally. It rises when the barometer is high, the air dry, and the sky clear, at which time we perceive very little of the effects on the ground; it falls when the clouds are low, or the air laden with moisture; then the whole district is equally enveloped in the haze. In general there is a movement of the air and a motion of the smoke in a direction more or less horizontal, from the top of the chimney. By this means the highest objects are first attacked and the trees decay from the summit or from the upper part of that side exposed to the current. They resist the enemy for many years, keeping for a long time at least one side fresh; even the owners do not for years perceive that the district is gradually becoming unfit for plants of great height, but, as they lose some favorite flower or shrub, they pitch on some person most easily attacked, and blame him for all the mischief. About St. Helens there are many miles of trees broken, stunted, and rotten, and between all the towns of Lancashire, according to the prevailing sweep of the wind, there are lines of dead hedges. Yet the young shrubs grow up, without fear, as fresh and beautiful as anywhere, and all faith in their prosperity not being lost, there fortunately are still found persons who plant them. Absolute destruction is caused only by the direct action of the smoke, but a general weakness may be seen extending far beyond this, resulting in a less capacity of resisting the attacks of external influences. As to the effect on the inhabitants,

the question becomes exceedingly complicated, but the registrar-general's returns are an unanswerable reply as to the result of the total influences of the district. Few people seem clearly to picture to themselves the meaning of a decimal place in the percentage of death, and few clearly see that there are districts of England where the deaths, at least in some years, and when no recognized epidemic occurs, are three times greater than in others. When we hear of the annual deaths in some districts being 3.4 per cent., and in the whole of England 2.2, it is simply that 34 die instead of 22, whilst even that is too slightly stated, as the whole of England would show a lower death-rate if the towns were not used to swell it.

For the New York Coach-maker's Magazine.

### WHY PANELS SPLIT.

RAHWAY, N. J., March 28th, 1859.

PERMIT me, through *our* Magazine, to give your readers my experience with regard to the splitting of panels from the effects of frost. Now, it is really annoying to a journeyman, and very expensive to a boss coach-maker, to have the panel of a good job split; especially should the body be in color or varnish. Very frequently the body-maker is blamed, and has to put a new panel on, in place of the one split by the frost, which is very unjust. I have known body-makers discharged for refusing to comply with the foreman's unreasonable request to mend a split panel. That foreman knew something; Echo says, something. This is a matter in which bosses, as well as journeymen are interested, and should they adopt the following method, split panels will be of rare occurrence:

Simply have the inside well "slushed" with rather thick lead paint (not scrapings of the paint pot), mixed with boiled linseed oil—mind! not one drop of turpentine or japan. The reason why this will prevent the panels splitting is, that the boiled oil and lead form a protection to the moisture contained in the panel against the action of the frost, the outside also should be, of course, well painted. The moisture, contained in what we term a dry panel, is from eight per cent. upwards. This can be ascertained by baking the board in an oven, weighing it before going in, and again, immediately after it is taken out. The board will commence absorbing moisture as soon as exposed to the air. The moisture, which is merely so much water, freezes, and, by a well-known law of nature, expands, and destroys to some extent the adhesion of the fibres of the wood—and, consequently, the panel splits. Of course, I do not assert that the panel will not freeze when painted on both sides, but I do assert that it will not freeze half so much as when one side is exposed to the weather without paint. The boiled oil and lead also form a tenacious coating to the wood, and it is well qualified to prevent the heat shrinking the panels when they are on the bodies, as it effectually prevents the moisture in the wood evaporating. Any coach-maker knows that it detracts from the beauty of a coach-body, should the panels shrink and become flat between the strainers. If the above method should serve to prevent a single panel, either in color or varnish, from splitting, the boss of that job will have gained more than the value of one year's subscription to the now indispensable Coach-maker's Magazine. We have had eleven body-makers on coaches all winter, and we have not had a single panel split by the frost.

Yours, &c., A. DUXBURY.

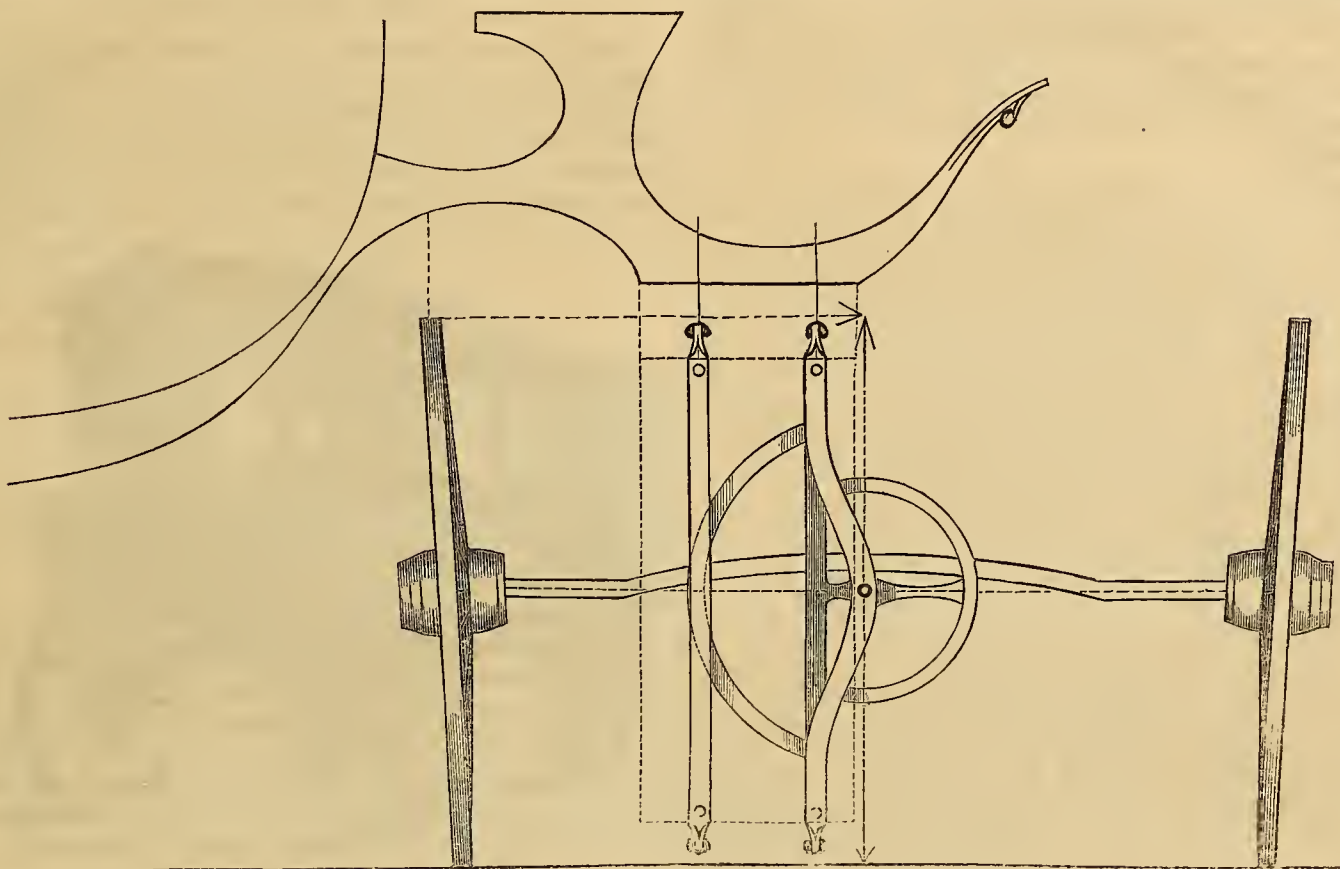

DIAGRAM FOR DETERMINING THE PROPER PLACE FOR THE KING-BOLT.

For the New York Coach-maker's Magazine.

## GEOMETRY OF CARRIAGE ARCHITECTURE.

BY A PRACTICAL COACH-MAKER.

## PART FOURTH.—HANGING UP THE BODY.

*Continued from page 205.*

THIS diagram shows the manner in which a calculation may be made for placing the kingbolt in its proper place in a carriage. You must first find how much space there will be in the front spring to play; then add the space on to the height you require the front wheel, which gives you the mean height of the arch of the body from the ground. An inch or two more is desirable to allow for the sagging of the body; then mark how far back the wheel can cramp in the arch, without interfering with anything, and draw a perpendicular line, at the base of which mark as much turn-under as the wheel requires; from this point mark half the width of the track, and draw a perpendicular line, which is the line for the kingbolt. From this line you can see where it would be desirable to bolt the carriage to the body, which will show how far the centre line must be placed from the kingbolt. A man of experience can calculate for such in less time than it can be explained. Like all other calculations about the construction of the job, it should be done on the draft-board at the commencement, and booked; saving all the unnecessary expense of building up and taking asunder, and altering irons, to do which runs away with the profits that should go into the employer's pocket. When a foreman is necessitated to resort to such means in getting up work, it will reduce the profits of the concern considerably at the end of the year.

For the New York Coach-maker's Magazine.

## WANDERINGS IN THE SUNNY SOUTH—No. 1.

BY JOHN SHUTTLEWORTH.

COLUMBIA, S. C., April 7, 1859.

COLUMBIA is a beautiful and well laid-out city, of about 15,000 inhabitants. A more energetic people are not to be found in the State. The inhabitants are more tasty than in the lower counties, and second in number of population to the capital of the State, and it will at no distant day be the seat of considerable trade. The Military Academy, the U. S. Armory, the U. S. Arsenal, the City Water Works, the new State House (which is a splendid and substantial affair), the State Insane Hospital, Columbia College, besides a vast number of the most princely mansions, adorn this town, and contribute largely to its beauty.

Mr. Editor, I will say nothing about the streets, delightfully shaded with trees, and numerous other objects of interest to the traveler and lover of nature. But, Mr. Editor, I must not forget, in all my wanderings, that which all your readers are so anxiously expecting to hear. Before proceeding further, however, let me here remark that it must not be supposed, from the preceding observations, as regards this city, that the same hurry and bustle of business, characteristic of the city from whence your valuable Magazine is issued, are observable here. It is not so, but, like nearly all other Southern cities, trade is carried on in a quiet, unobtrusive manner. Here a Northerner misses the noise of a thousand spindles, the clatter of the weaver's shuttle, and the hum of countless workshops, and awakes to

the consciousness that man here lives nearer to those physical laws given us at the beginning, but which have been shamefully neglected by us in these degenerate times. But I have wandered from my subject. Let us now take a retrospective view of the manufacture, trade, and consumption of carriages.

There are two carriage repositories in this place—Mr. Frazee's, the oldest, and Messrs. Brennan & Carroll's. The former manufactures a little custom work, such as Rockaways, and light open buggies, and keeps a very fine selection of carriages, perhaps the best in this part of the country. I will here notice a fact well worthy the attention of journeymen adventurers. They will, in the first place, try to realize the true condition of affairs, and the prospects of the future may have before them. The South is favored with a large colored population, thousands of whom learn trades and make this their means of support, and a source of profit to their masters. Such, then, being the case, few white workmen are required, and those few must be of the first quality. There are a great many of these servants who equal our northern mechanics. I have myself had as good and substantial and well-finished piece of work as I ever wish to see. Many bosses, I am glad to say it to their credit, look upon this negro journeyman system as a system intensely at variance with the trades, and, consequently, put them to the more menial work of the establishment. Still, as long as the slave is allowed and encouraged to compete with white labor, many situations which the white tradesman could fill with ability, he is deprived of, and a mere pittance given to the slave for the performance of the work in an inferior manner.

Hoping, however, that this state of affairs may change ere long, for I perceive there are some efforts being made for the evil just spoken of; yet, doubt sometimes arises in my mind if such a revolution in southern customs can possibly take place. I am almost persuaded they are well-founded, for it is a well-known fact to all who have visited the South, that the master would rather part with anything else in his possession, than with his servant, so great is the profit derived from his labor. Indeed, there are many in some, and perhaps in almost all our southern cities, that reap their support from the labor of three or four of these "trials."

Mr. Editor, I have penned these few lines for the benefit of the working community, that they may not be deluded by the sound of easy times and great wages. In this part of the country, wages are only \$2.00 per day, and board for a single man is from \$3.50 to \$4.00 per week. If a married man, he will find provisions, house-rent and clothing are expensive.

**WAGONS FOR TEXAS.**—The brig *Mystic*, which recently sailed from New York for Indianola, took out, as a portion of her cargo, over fifty heavy wagons, manufactured by a firm in Philadelphia, to be used in Texas, in transporting goods from the coast to the interior towns. The wheels were 5 ft. 6 in. high, and strongly made. They are intended to be drawn by oxen or mules, in some instances by twenty or thirty animals to a wagon. The enormous loads sometimes carried, range from two to four tons, and sometimes are drawn 400 miles. The tires on these wagons were six inches wide, to fit them for the soft, springy soil over which they must pass many miles back in the country.

### A NEW AMBULANCE.

THE term "Ambulance" comes from the Latin *ambulo*, to walk, or go step by step, and means a movable hospital or sick-house for the wounded, placed near a field of battle. This vehicle is so intimately associated with war and its melancholy results, that this subject is one rather repulsive than pleasant, yet it may be satisfactory to know that the

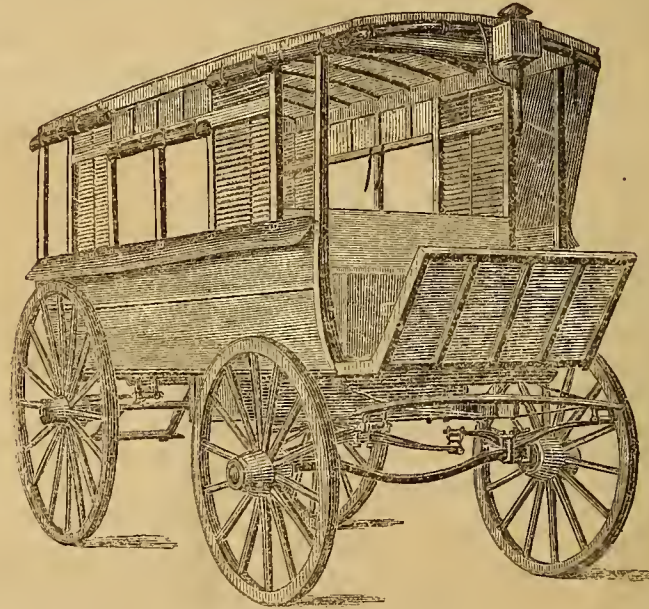

FRONT VIEW OF DR. MORE'S AMBULANCE.

inventions of modern times, if not calculated to prevent warlike contests, yet, doubtless, in a measure, serve to soften their miseries.

The Ambulance is said to have been first used in the armies of France. Any one who has read the account of the sufferings of the allied armies before the walls of

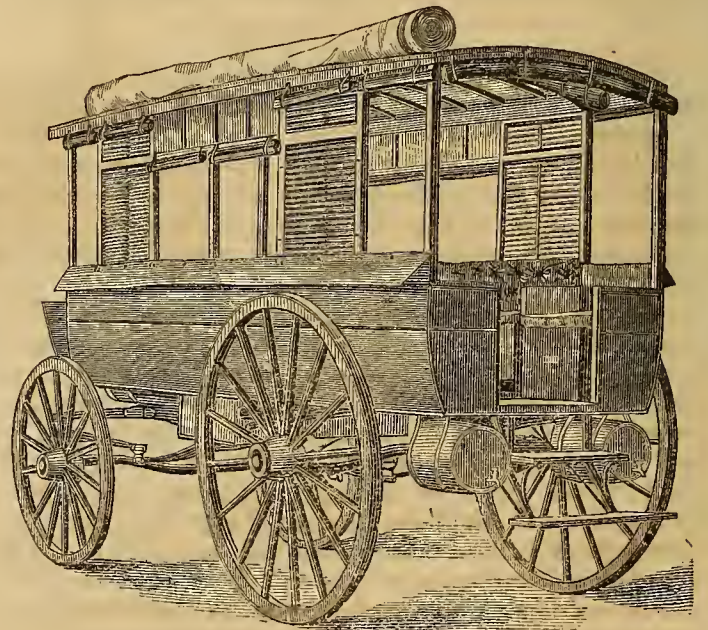

BACK AND SIDE VIEW OF DR. MORE'S AMBULANCE.

Sebastopol, in the Crimea, will not fail to remember that, in providing for their sick and wounded, the French were immeasurably ahead of their allies. This was so apparent

as to have attracted the attention of all classes of correspondents from the seat of war, at the time.

The Ambulance here illustrated is the invention of Doctor ——— More, late surgeon in the United States army, and was built by Messrs. Brewster & Co., of New York city, weighing about 2,000 pounds, capable of carrying eighteen men, and supplied with six large medicine and one urinal chest, a portable desk or counter for compounding medicines, and two ten-gallon water kegs. The falls to the seats are raised upon jointed legs, and the whole surface is one bed.

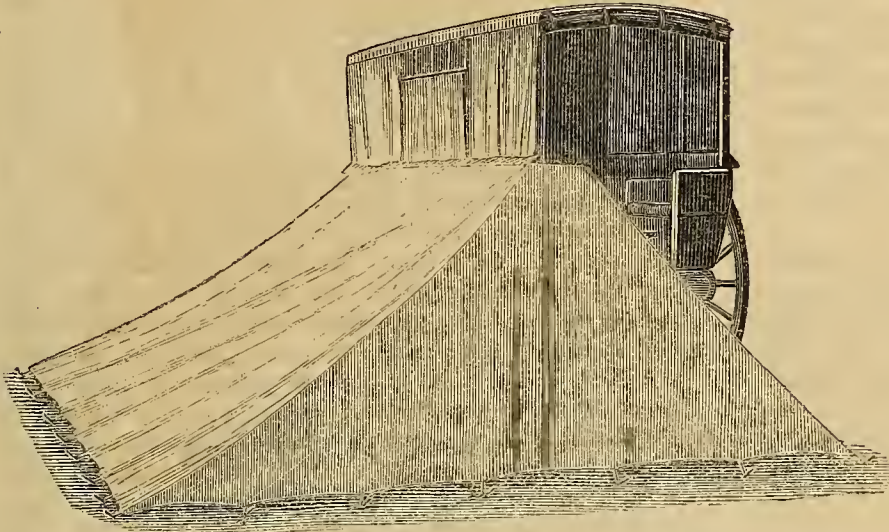

THE AMBULANCE AS A CAMP-WAGON WITH CANVAS EXTENDED.

Above that is a canvas stretched for men with fractured limbs. When used as a camp-wagon it will, with the canvas extended, accommodate thirty-five men.

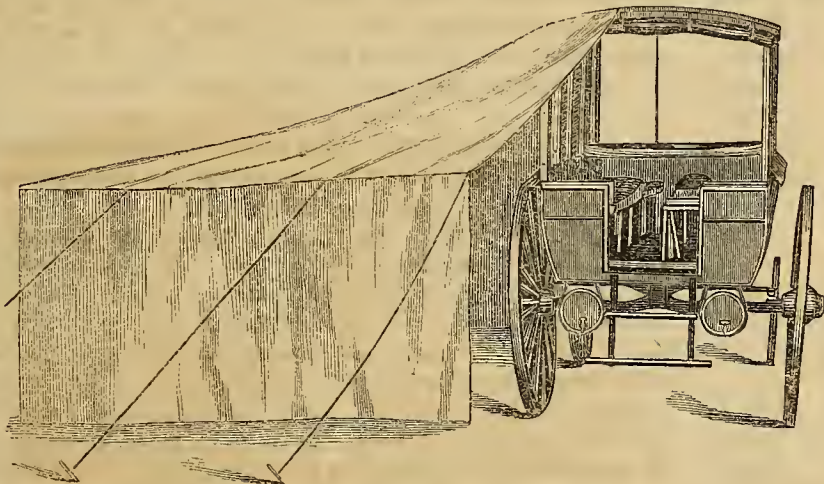

THE VEHICLE AS A HOSPITAL AMBULANCE.

When used as a permanent hospital-ambulance, the canvas may be raised sufficiently high from the ground to be used for surgical operations, or as a mess-tent for the officers of the surgical staff.

This invention has been inspected by General Winfield Scott, and approved by him; the chiefs of the medical staff, and the surgeon-general of the United States army. The War Department has also appointed a committee of officers to examine it and report officially. This vehicle is intended to be drawn by four horses. It was patented in 1858. S.

## The Home Circle.

For the New York Coach-maker's Magazine.

### LOVE AND MONEY.

BY MARY E. THROPP.

#### CHAPTER I.

"As wealth is burthen of my wooing dance."—SHAKESPEARE.

"Tom," said Gustavus Adolphus Flash, bursting into his friend's office one morning last spring, "do you know Dr. Richard Howard's sister is out staying with him at Ridge Farm?"

"No, I didn't know it—hope it's mutually agreeable and pleasant, but what of it?"

"What of it! why, man, she's the greatest catch in the country. Her mother was old Howard's second wife, this girl is their only child, Dick's half-sister, and she is to inherit her mother's dower, a clear hundred thousand, only think of it!"

"Well, what if I do, Gussy—what's that to do with me, or either of us; more convenient to the lady than interesting to us, decidedly. The grapes are sour, when we talk of wealth, Gussy; let's be philosophical and despise it. Shakspeare calls this 'a working-day world,' and he's right. As for us, we'll work and win, won't we?"

"Precisely; that's what I mean to do, exactly. But, Tom, you'll do the handsome in this case, and keep out of the way, won't you? All the beaux have been standing aloof, as yet, fearful that she'll suspect their fondness for the golden charms; but I mean to break the ice forthwith. I'll just 'take time by the forelock,' and slip in in advance of them, on some business pretext or other; I'll start out to the doctor's this afternoon."

"Gussy," said Tom, earnestly, a look of disapproval sobering his fine frank face, "be a man, work and win enough for two, and then select some little body that will be a 'help meet' for you in the life-battle; but don't demean yourself so far as to settle down and be kept by a woman—anything but that for a being fashioned in God's own image, with the power to will and to do. Why, a hundred thousand would make you a perfect nuisance, man, to say nothing of what the lady might suffer in the speculation."

"Upon my word, Tom, you're civil; if I didn't know you so well, old fellow, I'd treat you to a knock-down argument. Listen to reason, will you? I shall like her, anyhow, from all accounts. They say she is young, good-looking, and quite intelligent."

"All very good, so far as it goes; fine appearance, fine intellect, probably, but what of the heart?"

"Untouched, as yet, I hear, but we shall soon see what we shall see," and Gustavus Adolphus Flash glanced into the mirror opposite, and twirled his unexceptionable moustache complacently.

"You misunderstood me, I meant to ask if her heart was cultivated. In looking for a wife, if I may ever be so

fortunate, I shall attend to the good qualities of the heart first, the head next, and the externals last of all."

"All that's well enough in its way, Tom, but I can't afford to marry a poor wife; I've too little myself. If I don't dance to the tune of a hundred thousand dollars, I don't dance the matrimonial dance at all, that's certain. But I must go now, good morning," and, with well-brushed hat slightly to one side, and cane flourishing, Gustavus Adolphus Flash walked leisurely down the street.

The above conversation, *verbatim*, occurred between two young lawyers who had come together from the town of A—, and set up their shingles in Cincinnati. They were born in the same town, went to school together, studied in the same office, had sought the same field for business, and yet they were in character the very antipodes of each other. Old Squire Flash had several sons, all of whom, Gustavus not excepted, were too proud and too indolent to work, and yet not rich enough to do without, consequently they were all anxious to draw a moneyed prize in the matrimonial lottery.

Thomas Temperly was the "only son of his mother, and she a widow." She had sewed, and saved, and striven in every way to set apart sufficient to give her beloved boy a thorough education, and had succeeded. The boy was naturally bright, and, boarding at home while attending the neighboring college, he was able to count and appreciate the cost of those long years of patient and loving self-sacrifice, and earnestly and well did he apply himself, and diligently did he strive afterwards to repay. He was already considered a rising young man, and the widow's humble cottage was already beginning to bear evidences of the thoughtful tenderness and care, as well as the good-fortune, of her affectionate son. There was a well-cushioned, ample easy chair, of rosewood and velvet, in the warmest, cheerfulest corner of the room; a family Bible, beautiful with clear large type on a Lepoy stand beside it; a handsome bookcase near, filled with her favorite authors; and, best of all, her boy's noble face opposite to her, reading them every Saturday evening, for the cars brought him home regularly to remain with her over Sunday. How the proud, happy mother blessed him and the God who gave him, in the fullness of her grateful heart—would that all mothers could do likewise!

## CHAPTER II.

"But yet his horse was not a whit  
Inclined to tarry there;  
For why?—His owner had a house  
Full ten miles off at Ware."—COWPER.

And now, my kind readers (comfortable and cozy, I hope, wherever you are), let me introduce you to a scene in the country. Time, drawing towards evening. Raining slightly, at first very slightly, but continuously. Stage, a fine old forest in Kentucky. Thousands upon thousands of brown colossal columns, whichever way one looks, arched with a green canopy, so dense and dark, that one can see nothing else on looking up, though one can feel very unmistakably the cold, mist-like rain drizzling down. In the midst of this darkness, dreariness, and, to be practical rather than poetical, abominable under-brush, meanders "a solitary horseman," "jubris," as old Squire Flash would say, which road—way I mean, there was no road—to take. The horse, upon which "the solitary horseman" sits cogitating, was "sponsible" enough, to use the same respectable authority, but he had one little failing and its accompani-

ment: he was hard-mouthed and headstrong. He had never been known to make "whither thou goest I will go" his law of action to any human being, consequently, from the time of leaving the straight road and entering the forest for a short-cut to Ridge-Farm, he had gone precisely whither the rider would not. The rider was spirited, so was the horse; the rider was persevering, so also was the horse; the rider was obstinate, even, and the horse was not one whit behind him. Much alike in many things, they should have been "wondrous kind," but there was this slight present difference, their intentions were at variance. The horseman intended to go to Ridge-Farm; the horse to return to a certain comfortable livery stable in the city. There was many a hard-fought battle between master and man. Master and man I say, and I say it advisedly, for up to this time the horse was successful, as one might easily gather, from the tired, nerveless, down-dropping arms, sit-still, despairing sort of position in the midst of briars, brambles and rain, to say nothing of the face, from the lower aperture of which, notwithstanding the unexceptionable moustache, a valley of oaths occasionally issued. There had been savings at the mouth, switchings and kickings, vigorous kickings, at the side, on the part of the man; on that of his antagonist, there had been plunging and rearing and rushing into every possible or impossible undergrowth, the more briary, thorny, and impervious the better, until unintentional and unheeded flags of truce were visible over every scene of action, to the decided detriment of a pair of immaculate unmentionables, that were rapidly reaching the time of being numbered among "the things that were." This was the state of things in which we have the honor to make the acquaintance of the one party, and renew that of the other, Gustavus Adolphus Flash, Esq. But things never remain long in *statu quo* in any part or portion of Young America. The master, conscious of his power, begins to exert it. He backs out, veers round, traverses the forest, gains the road, and is soon nearing the city at a rapid rate. Gustavus Adolphus F., like many another unsuccessful warrior, becomes resigned, "sticks on" (to use his own choice expression), and thanks his "lucky stars" that there is "nobody abroad" in the city, that is to say, no one of *his* acquaintance, or more particularly from "upper-tendom."

We beg his pardon, but there is some one abroad in the city, a lady, evidently, neatly and becomingly dressed, but without umbrella or covering of any kind to protect her from the rain. She walks fast through the drizzling rain. It is quite dark and she is belated—and yet another! a gentleman, positively, notwithstanding Mr. Flash's assertion to the contrary, with umbrella and overcoat. He walks rapidly too, nears the lady, looks at her, then at his umbrella, and steps up to her respectfully: "Will you accept my umbrella, madam? I have but a short distance to go and can do without it better than you."

"Certainly, sir," gratefully answered the lady, "I am much obliged—where shall I send it?"

The gentleman handed his card, bowed, and passed on, thinking the while of the sweet voice and pleasant expression of the lady's face, seen distinctly under the lamp, as he neared his boarding-house.

The lady was visiting in the city, had walked out in the afternoon, when it was yet clear, and meeting a ragged, distressed looking little girl, who, with tears in her eyes, implored charity, followed her to her home, a long way off, acted the "Good Samaritan," then, attempting to return

home, took the wrong direction, got lost, and finally found herself in a familiar street, not far from her friend's house, in the darkness and rain, as described. The umbrella was returned to the gentleman next day by a servant, with the compliments of the lady he had befriended, and so the incident passed.

(To be continued.)

For the New York Coach-maker's Magazine.

MOONLIGHT CHARMS.

SEE, amid a sparkling host,  
 Moves the gentle queen of night:  
 Now behind a cloud is lost—  
 Now shines beautiful and bright.

See! along, extended wide—  
 Fauned by Summer's softened breath—  
 Mountains, valleys, wood-hill-side,  
 Calling Nature's lover forth.

See the golden moon-lit stream,  
 Rippled by the evening's breeze,  
 And her mellow light serene,  
 On burnished tower and forest trees.

Hark! upon the listening ear,  
 Bursts the song of whip-poor-will;  
 Then 'twas distant—now 'tis near—  
 Glads the field and charms the hill.

Now, within this bosom burns—  
 Joy and ecstasy are mine—  
 Now my heart instinctive turns,  
 Owns such charms must be Divine. S.

Pen Illustrations of the Drafts.

THE OVAL HEARSE.

Illustrated on Plate I.

THIS fine draft of a superb hearse is furnished for our columns by Messrs. Baldwin & Thomas, who have built a number, one of which was sent to Cuba. We have seen nothing of the kind which has met our fancy as well as this. This preserves the general appearance of the coach better than the ordinary vehicles heretofore used for carrying the dead, and for this reason, if for no other, commends itself to the attention of our readers.

A few explanations may be deemed necessary. The outlines of the body present a panel, on which the carved work is laid so judiciously that it furnishes a splendid article. The silk curtains are shown behind plate glass. The modern plan of screening the trimmings from the damaging effects of the weather, by glass, is a march of improvement far in advance of our ancestors' time. The hammer-eloth driver's seat is an addition we have not seen in any hearse before. The whole hearse has so many original points about it, that we have no hesitation in saying that it must be valuable to any who may contemplate getting up a hearse. The manufacturers will please accept our best thanks for their kindness in furnishing it.

The following, from the *Newark Evening Post*, will be all that need further be said of it:

"Probably the finest and most beautiful hearse ever built in this city was shipped to-day for Havana by Baldwin & Thomas, No. 235 Market street, who are the builders. It is rich and massive, but not gaudy, the design being admirable, and the workmanship perfect. The body is of an oval shape, and its back and sides, above and below the glass, are splendidly carved. There are two sets of drapery, white and black, the one finished off in silver, and the other in black metal. There are also two sets of mountings, and two sets of ostrich plumes, one set being black-and-white mixed, and the other wholly black. The drapery, mountings, and plumes, are movable, so that the hearse can be arrayed in white for young, and in black for old persons. It is valued at \$3000. The already-great celebrity of Newark carriage-makers will be greatly enhanced by this specimen of their handiwork. There are four double sets of harness, valued at \$1000, which accompany this hearse. It is intended to be drawn by four horses. One complete set is silver-mounted, and the other is clear black, intended to be changed with the trimmings of the hearse. The harness was manufactured by Joseph Davy, No. 206 Market street, and is in excellent keeping with the grand appearance of the hearse."

For the New York Coach-maker's Magazine.

ARCHED BUGGY.

Illustrated on Plate II.

SHELBYVILLE, TENN., March 22d, 1859.

MR. EDITOR—*Dear Sir*:—I send you the draft I spoke of in my last letter. It is the first time I ever tried my hand at drafting, and I suppose it is very imperfect, but you can see from my sketch what it is meant to represent. It is an open-arched buggy, and is paneled up back of the fall. The bar being round, gives plenty of room in front.

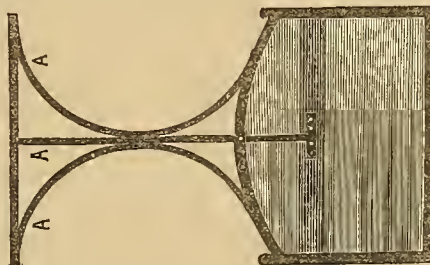

The above is a bottom view. *AAA* are iron stays, welded together in the middle and fastened with bolts, or screws. The sides of this buggy are carved. For a light, fancy job, I think it is the neatest I have ever seen. The wheel turns clear under the body. There is a stay on the fifth-wheel, which prevents the wheel from striking the body.

Respectfully, yours,

P. NELLIGAN.

NEWARK BUGGY.

Illustrated on Plate II.

We are indebted to Messrs. Douglas & Post, of Newark, N. J., for this style of buggy, who, we understand, were its originators. There is considerable novelty in the design, which is so apparent that we need not go into more minute details. We trust that it will be received with favor by the friends of our Magazine.

For the New York Coach-maker's Magazine.

CARDINAL BRETT.

Illustrated on Plate III.

This design makes a very neat and light summer carriage. The front seat can be raised upon carved blocks, if preferred, to the panel block. Any width track is suitable for this job, and then leave sufficient room for the locking.

J. IRVING.

## Sparks from the Anvil.

### SHAFT COUPLINGS.

Complaints, loud and long, were formerly made against

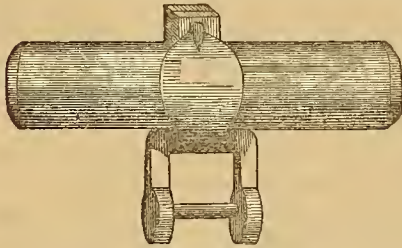

the "rattling" of shaft-connections with carriage axles; but this age of inventions has now provided an efficient remedy therefor.

One of the most popular of these, is known as the Miner, Stevens & Saunders' Patent-Coupling, here illustrated.



For a cheaper, but still a useful one, the reader is referred to our friends, H. D. Smith & Co.'s advertisement in this No.

### SCIENCE OF STEEL MAKING.

THERE is certainly a very great difference between the qualities of cast iron and beautiful cast steel, and yet the difference between their compositions is but trifling. Cast iron and steel are compounds of iron and carbon; hard wrought iron contains, of carbon 0.4 per cent.; soft steel, 0.5 per cent.; hard steel, 2.4 per cent.; common cast iron, 2.5 per cent.; and hard cast iron, 5.0 per cent. From the composition of cast iron and steel, it is evident, that, if the former can be deprived of its surplus carbon, it will become steel. In England, the processes in use for doing this are, first to decarbonize the cast iron, and reduce it to the condition of wrought iron, after which, it is again carbonized to that degree which renders it steel. This is certainly a very circuitous way of arriving at the result—nevertheless, it is the common mode. In Germany, on the other hand, steel is now made by taking away the surplus carbon from the cast iron, by a puddling process, and this appears to be by far the most scientific method.

It may be said, that there are several impurities in cast iron, such as silica and sulphur, which require to be removed, hence it is necessary to do this by the English method, in order to produce good steel. This is a mere assertion without proof; for since steel has recently been made in Germany by the short process, there is no reason why the longer one should be followed anywhere. This is a subject of great importance to our iron manufacturers, because cheap cast steel is a great desideratum. It is nearly three times stronger than wrought iron, and, being of a uniform texture, it wears more uniformly, hence it is the best material for machinery, and, could it only be produced as cheap, it would be universally used in preference.

For the New York Coach-maker's Magazine.

## DESIGNS FOR FANCY PERCH AND BODY STAYS.

BY J. W. PARSONS, OF IND.

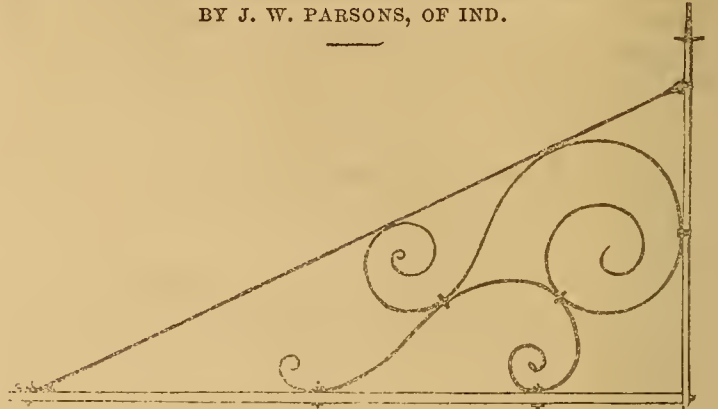

SUGAR BRANCH, IND., April 9, 1859.

MR. EDITOR—*Dear Sir*:—I herewith send you a design for a fancy stay and two designs for braces to Phaetons or light Rockaways. These designs, when made to swell from

the collar each way, and the leaves and scrolls are plated, look very fine. This kind of stay is very difficult to make, as it is very complicated. It may be said by some that these are merely imaginations, and that they cannot be applied to practical use, but I can produce plenty of testimony stating that these designs were got up for practical purposes.



In the March No. of your Magazine I noticed an inquiry concerning fifth-wheels, and asking for a rule for the different sizes, &c. In the first place, the size of the fifth-wheel in all light buggies and carriages, for one or two horses, should have

a sixteen-inch fifth-wheel and made out of three-fourths inch half-round iron, the holes punched before bending, and they should be 23 inches between the centres of the holes, and a heavy job should be made out of one-inch half-round iron; but it seems like teaching a hungry man how to eat, when I try to

tell a carriage-ironer how to make his irons.

[Our correspondent is a little too fanciful in his designs for us, but, as they may meet the tastes of a portion of our





readers, we give them with pleasure. He, however, would make his fifth-wheels a little too heavy for this section of the country. For light buggies, we think, a *full* half-round bar sufficiently heavy. We would never think of punching the holes for bolts in a fifth-wheel, where drills are as plenty as they are in these parts. If our correspondent does not possess one already, we advise him to get one immediately—he will find it a useful “fixture” in any smith’s shop.—Ed.]

## Paint Room.

For the New York Coach-maker's Magazine.

### THE REASONS WHY VARNISH PITS.

SUGAR BRANCH, IND., March 29th, 1859.

MR. EDITOR—*Dear Sir*:—In looking over the different numbers of the Magazine, I found a correspondent who complained of the bad luck he had had in varnishing a body. He says, of the two bodies varnished at the same time, that one of them looked bright and clear, while the other looked like the skin of a person badly marked with the small-pox.

Now, sir, I can answer the above from experience. Some time during last summer I had a case of the very same kind, and the reason that I thought had caused it to settle in this way, was this: when I am about to varnish a body, after I have dusted off all the loose dust with my duster, then I wring out my buckskin in clean water and wipe off the body, and by so doing I remove dust that could not be removed without the aid of the dampened skin, and as the body that I was about to varnish was very “tacky,” it retained a considerable portion of water from the skin, which had a tendency to settle wherever there was a drop of water. Your correspondent’s job might have been a little tacky, and his varnish brush, perhaps, was not well cleansed, and then if he cleans off his body in the above manner, why, I think that the mystery is fully explained. And again, I remember once getting ready to varnish a body, and when I commenced I found I could not spread on a brushful of it, before I found it would crawl as though it had been greased, and I was stumped for a short time; but at length I removed the body from the room, out on to a platform, so as to experiment by trying what effect the sun would have, and after waiting a short time for it to get a little warm (this being my object, as we had taken the stove out of the room on account of warm weather); after waiting about a half an hour, I applied the varnish, and to my utter astonishment I had as brilliant a gloss as I ever had on an out-door job during my little short experience as a painter.

Now, the facts in the case are, that the varnish was a little warmed by the morning sun shining against the side of the building where the varnish was kept, consequently it was warmer than the body, thus causing it to crawl as does water on an oiled surface; but, as soon as both were warmed to the same temperature, the difficulty was overcome at once.

Again, perhaps the body, that had such a bad look after it was finished, was varnished in an open, dirty room, and being a little tacky, caused by using half-boiled varnish or

by adding too much raw oil; and your correspondent’s varnish brush had been kept standing in an old glass tumbler that he got at the house, broken into two pieces, and had stuck it together with some keg lead, just to make what he thought a nice thing to hold his brush in—this being a better way than to keep it in water amongst other brushes.

I would not be afraid to wager fifteen cents, that the room in which the bad job was done, was cold and dirty, and that the previous coats of paint and varnish had not been applied in the same manner, and that he varnished it first, and that he varnished it too soon after rubbing it down with pumice-stone and water; or that his varnish brush was full of oil and settlings from the bottom of the cup. Thus, by the time he got the first body varnished, he had worked all the filth out of his brush, and, as a matter of course, it did not affect the other job. It cannot be said that it was the varnish that caused the difference in the looks of the job, unless he varnished the good job first, and then adulterated the varnish, with oil, japan, or turpentine, to such an extent that it caused the varnish to settle, as stated by him, and if he was in the habit of wiping off the body with a chamois-skin, previous to applying the varnish, the body being a little tacky, it is a natural conclusion that the surface was a little damp, and that it would settle in the above-described manner.

Yours, respectfully, GEO. P. TINKER.

For the New York Coach-Maker's Magazine.

### THE BLISTERING OF VARNISH—A QUERY.

SHELBYVILLE, TENN., April 22nd, 1858.

MR. STRATTON—*Dear Sir*: You will oblige me by answering the following question: If a job that has stood in the show room six weeks after painting, is sold, and the purchaser allows it to stand for two hours with the sun striking on the back panel, and that panel blisters, is it the fault of the painter or the varnish, or is it a natural consequence of the exposure? An answer to this in your next number will oblige me. P. NELLIGAN.

[We commend the above to the attention of coach-painters, and shall be pleased to have their opinion on the subject, for publication in our next issue. We are promised an article from one who has had long experience in the business, on the *crawling, shriveling up, &c.*, of varnish, which we hope to have in time to present to our readers in the July Number of this Magazine.—Ed.]

### SUBSTITUTE FOR RED-LEAD OCHRE.

AN ochre found at Fontenville, France, has been patented by MM. Banchard and Clavel, of Paris, as a substitute for red-lead in painting, and also as a cement for some purposes. Its composition is, silica, 50.00 parts; oxyd of iron, 14.50; alumina, 26.60; carbonate of lime, 7.60; sulphate and phosphate of lime, 1.20 parts. It is ground fine and mixed with oil in the usual manner for painting, and is called “Burgundy red.” It is stated to make a good cement for steam boilers, by mixing it as follows:—Ochre, 66 parts; oil, 15; lime, 11; chalk, 8. These substances are kneaded together until they have attained to the proper consistency, laid into the seams of iron, and allowed to dry before the boiler is used. Any of our readers can procure these materials, and make experiments as to the merits of this composition.

## ORIGINAL ORNAMENTAL DESIGNS.

*Illustrated on Plate IV., Vol. 2.*

No. 1. This fine original design has been kindly contributed to our columns by our friend, Mr. J. C. Norris, of Picton, C. W. With it he furnishes the following directions for coloring and shading it:

"The dolphins are to be painted green, and shaded with the same color, somewhat darker. After these become dry, the shading may be further enriched, and made more deep in the shadows, by glazing the figures with a little burnt *terre de sienna*; the water and sky painted with blue, and the drapery of the child with pink or rose color, shaded with lake. The scroll work may be gilded or painted, according to the fancy of the artist. Should the scroll-work be gilded, it may be shaded with asphaltum; the flowers with white and lake, shading with ultramarine-blue.

No. 2. This design was accompanied by the following letter of explanation. We hope to hear from our friend again:

HILLSBORO, MONTGOMERY Co., ILL., March 16, 1859.

MR. EDITOR—I thought, as I had a few leisure hours, I would devote them to drawing for your Coach-maker's Magazine, as the coach-makers in the West wish something larger than you have been giving, in the shape of ornaments. If this suits your taste, please use it.

As coach-painters use the phrases outside and inside to the scroll-work, let it be understood that the outside must be colored vermilion red; the inside purple, shaded with dark tint of each. For light, a mixture of equal portions of white and chrome yellow; the shield, the top part permanent, blue and white; the lower part must be painted with equal portions of white and black; the stripes, scarlet lake; the cord, gold color, mixed with white and No. 2 yellow; the star is white; the shade of the shield should be mixed with yellow and umber. The small leaves should be put on after the scrolls are painted.

W. R. TRUESDELL.

No. 3. This is from the pencil of our special designer. The scroll-work may be laid on a metallic ground or painted in relief, according to the fancy; if the former, it will look well when shaded with asphaltum or raw sienna.

The head of the deer, of course, must be done to imitate nature as closely as possible, of some fawn-color.

## Trimming Room.

### IMPROVEMENT IN TRIMMING CARRIAGES.

It has been well observed by a celebrated writer, that "Change is stamped on all things here." In nothing has this change been more beneficial than in that which has been wrought in the use of the material with which carriages are now trimmed. Some thirty years since, and such a thing as leather for cushions and other linings was not thought of. In fact, the enameled leather wherewith to do it, could not be found. Blue or drab cloths were

about the only material used for such purposes, and "swinging tow" or salt hay the common "stuffing." The cloth soon became soiled and dirty, and the stuffing "as flat as a flounder" in a few weeks. One cannot but feel, as he now passes through a line of neatly-stitched and clean carriages, that great improvements have taken place in this respect. We know there are yet some few "old fogies" who will scarcely allow our taste in this respect to have been changed for the better, but the fact "sticks out" so apparent to every person of genuine taste, that we have no hesitation in saying that the present generation of trimmers are capable of adding adornment to our carriages never dreamed of by any one in former days.

To the above neatness in ornamenting cushions, falls, &c., we are, in a great degree, indebted to the stitching machine. It imparts a beauty to some portions of a carriage which the most hostile stitcher cannot deny. Those who may wish to get "the best" are referred to the advertisement of I. M. Singer & Co., in our advertising columns.

### THE SPRINGING OF TOPS—A PREVENTIVE.

It is an old proverb, that "an ounce of prevention is better than a pound of cure." With this idea, we present a remedy against the unsightly derangement liable to occur in light buggies, where the side curtains are made to take off, and where the joints are inclined to throw a top forward after a little use, since sufficient strain cannot be had in the back-rail to prevent it, without destroying the sweep of the back-bow.

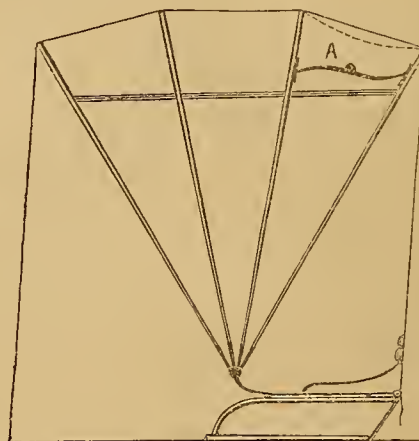

A is a short joint extending from the back bow to the next, where the ends are secured to plates secured to the bows by screws, which plates are so constructed that the joint has freedom in springing, as in any ordinary top joint. It will be understood that this joint must be placed out of sight between the head-lining and the outside leather covering. Of course this contrivance can only be applied to a top where the side curtains are taken off, and the hand may be passed between the inner and outer coverings to regulate the joint for throwing the top down at will. The joint, in the French style, drops down and folds between

the bows, when the top is let down. The dotted line above the joint A, shows the effects caused by the contraction of the leather in many tops. With the remark that this plan has been tried and found effectual, we leave the subject with the reader, promising that if he can give us a better plan, we shall take pleasure in presenting his views to the public.

#### SECURING THE BOOT TO A BODY.

It is remarkable, when we consider the improvement made in later years in this part of a carriage. The earlier manner was by using plain tacks. This was followed by using black lining nails, unquestionably a great improvement. To these succeeded the silver-plated and ivory-headed nails. These, however, aside from the liability to tarnish of the one, and the liability of losing the head off of the other, have always been looked upon as too gaudy and fanciful for refined and correct taste, which has restricted their use generally. The black-headed nails have consequently "had it their own way" until recently. But a change has now taken place. The "tacks" are again in use, but this time they are *invisible*. In New York the present fashion is to first—after the boot is properly fitted and otherwise prepared by stitching—turn the side bottom-side up, having the inside out, and then to nail the boot in its place; and after this is done, to draw it up over the top of the frame of the body on which the seat is placed, and there to nail it secure. By this operation the heads of the tacks are all hidden, and the boot, when finished, presents a smooth and neat surface to the eye. Of course, the boot must, in finishing, be sewed up the back corners. Some trimmers cover the raw edges of the leather with a welt, but the neater mode is to blacken them after sewing.

**STIRRING UP THE HACKMEN.**—Strangers visiting New York will not have failed to notice the great number of coaches standing around the Park. These have become so numerous that they are a nuisance rather than a convenience. To remedy the evil, the Board of Aldermen have lately passed an ordinance directing the Mayor's Marshal to select twenty-five coaches from the number at the City Hall Park, and send them up to Madison Square, about one mile and a quarter up town. This, some of the hackmen are opposed to, and in a fit of indignation, they cry out against the arbitrary nature of the measure. If it is enforced at this time of the year, when so many of the citizens are leaving town for the country, they say it will be the ruin of those removed higher up town. This measure is supposed to have arisen from the influence of hotel proprietors and the drivers about them, between whom and the public hackmen there appears to have sprung up a jealousy, which we trust will be beneficial to the public in more ways than one.

## The New York Coach-maker's Magazine.

JUNE 1, 1859.

E. M. STRATTON, Editor.

#### TO READERS AND CORRESPONDENTS.

*All letters directed to this office on business, NOT relating to the Magazine, but solely for the writer's benefit, must inclose a stamp; if requiring an answer, two red stamps. Orders for a specimen number must be accompanied with nine three-cent stamps. When these terms are NOT complied with, no attention will be given them.*

**OUR RULE.**—All subscriptions terminate with the numbers for which advance payment has been made. Those wishing to continue will, therefore, see the necessity of renewal, by sending in the money in time. We intend to regulate our Edition of the SECOND VOLUME as near the wants of the craft as possible, so that an early order is desirable.

**AGENCY**—To COACH-MAKERS.—The publisher of this Magazine offers his services to fill orders for any article *his friends may want, to be found in the New York market, FREE OF CHARGE, where the individual is a subscriber. None but orders inclosing the cash are invited. Letters of inquiry MUST contain two red stamps.*

**E. B. OF OHIO.**—The design for a "lazy-back" will appear in our number for July. Your kind considerations are worthy of our best thanks.

**J. W. OF N. J.**—We have some half dozen times announced that all subscriptions must commence with the volume, which begins with the June No. The game of sending specimen numbers, without the pay, is "played out." Can supply complete sets of Vol. I.

**R. M. OF OHIO.**—This sending for a particular No. of the Magazine, three months old, looks very much as though you knew about as much about what we are publishing as any specimen copy would show you.

**D. M. C. OF PA.**—The Harness Maker's Journal "went in" more than a year ago. We are told that the Publisher has gone to Texas.

#### A VIEW FROM AN EDITORIAL STAND-POINT.

ONE year ago, when we started this Magazine, we claimed everybody as our friends, at least as long as they took our Work, *and paid for it*. More than this, we acknowledged that we made no pretensions to any particular degree of disinterested benevolence in placing our editorial efforts before the craft, but frankly confessed that we had engaged in the enterprise with the hope of making it pay. With these sentiments in our mind, we gave a wide invitation to our fellow-craftsmen to send in their names, and left it with them to send in the pay on receipt of the first Number. Some sent the "needful" along previous to the issue, some on the receipt of the first Number; but we are sorry to say, that there were some *pseudo* "friends," who have not only "patronized" our Magazine to death, but gone and sold it, and—spent the money. We have the history of some of these "fellows'" doings that would form a chapter second only in interest to the operations of our "old friend" beyond the Alleghanies, who, we are told, has "ent stick" for Texas, leaving his "card" with a long retinne of mourners.

We do not complain of the craft generally; with these

few exceptions, we have found them generous and kindly-disposed towards us, so that—although we nerved ourselves for perplexity and trials—upon the whole we have found our position one of pleasure and satisfaction, and, we may say, of profit; for we shall at least realize, the first year, one thousand dollars over our outlay, which we consider as doing very well, when the extremely “hard times,” which have affected almost all departments of business, are taken into the account. The past year was one of severity for even those old and long-established periodicals—and some of them yielded to the pressure; yet, amidst it all, the sunshine of encouragement from a generous public enlightened our foot-path, and cheered us on until the close of the volume. Compared with one year ago this time, we feel to rejoice, in view of the increasing demand for carriages, and that that demand will not fail to furnish the *needful* wherewithal to give us a liberal subscription for the current volume.

We have always believed that there were a sufficient number of coach-makers who could, and *would*, lend “material aid” to any enterprise of this sort, where they had reason to think that the publisher had the disposition to do “the right thing” by them. We have found no reason to change our mind in this respect, except it be to accord them more praise than our previous opinion of them would allow. The truth is, that the generous intimations we daily receive from all quarters, that our friends intend to put forth extra exertion to circulate our second volume, is truly gratifying. We hope that their success will be commensurate with their good intentions, and then we are certain that *THE NEW-YORK COACH-MAKER'S MAGAZINE* must and will prosper. With a few remarks in reference to the future of this Magazine, we shall close this article.

With commendations from all quarters ringing in our ears, yet we have not been exactly pleased with some things ourself. The greatest trouble has arisen from the difficulty we have found in obtaining the requisite and uniform quality of paper whereon, monthly, to print our work. We, from the commencement, contracted with certain parties to supply us regularly, and for five or six months we had no reason to complain, but for the last portion of our volume—although we have paid the same price through the year uniformly—we have been supplied with an inferior article.

We have now taken this matter into our own hands, and shall buy our paper, in future, directly from first hands, and hope hereafter to give through the entire year a uniform quality of paper, like that on which this Number is printed. To ensure this uniformity we have ordered paper made expressly for us, by a house in which we think we can rely, and shall have sufficient tinted for the next six months to ensure a uniform color to the plates, which under no other arrangement could be done. With these remarks additional to what we have said in our prospectus and elsewhere, we

leave the matter with an intelligent public, who, we are confident, will bestow on us that patronage which this Magazine may merit.

#### AN ENGLISH COACH-BUILDER'S BENEVOLENT INSTITUTION.

THROUGH the kindness of a friend, we are in possession of several documents relative to the proceedings of the London Master Coach-builder's Benevolent Institution, as it is called, organized at the Carriage Bazaar, King-street, Portman-square, London, January 22nd, 1856. As these papers may interest some of our readers, we shall, by way of history, subjoin a few details.

The chief objects of this Institution are, to furnish temporary relief, or permanent annuities (according to circumstances) to deserving master Coach-builders, their widows and children, and to their clerks and managers, who may fall into distress from sickness or unavoidable misfortunes.

The first anniversary meeting, at the end of one year, was held in the same place. The meeting was opened by the Chairman, John W. Peters, Esq., who announced that they were “met to commemorate the first anniversary of an institution which was intended to be a haven and a home for all who stood in need of it: to furnish relief to those of the trade whose misfortunes in business had rendered them destitute, and who, from old age, or infirmity, were now unable to maintain themselves.”

This Institution appears to have originated among a few Coach-makers in England who had been exhibitors in Paris. In about three weeks after the organization, the donations were announced as amounting to £1060 10s., and the annual subscriptions to £133 7s. 6d. To show the further progress, after the rules had been proposed and agreed upon, at the second general meeting, held in June following, the donations had increased to £1665 6s., and the annual subscriptions to £263 9s. To secure the permanency of the Institution, it was decided upon, at this meeting, to purchase £200,000 stock, which should be considered as a minimum, not as a maximum investment. By the 3d of November following, the Committee had accomplished their object, and found themselves in a condition to bestow upon needy persons sums amounting to £40.

Having, as a public journalist, been applied to for “hints” relative to the formation of Societies here, we present the following extract from the Report of the First Anniversary Meeting, which may afford some valuable suggestions to financial committees in this country:

“A plan was organized for obtaining subscriptions. The metropolis was divided into districts, and each member of the Committee was furnished with a list of such Coach-builders as resided in the district assigned to him, in order that he might personally solicit their assistance and contribution. The result of this plan was—a large accession

to the funds. Great numbers of circulars, detailing the objects of the Institution, were distributed through the provinces; and it is supposed that each Coach-builder in England has received one or more of these circulars, and a copy of the rules. Although the Committee have received very kind support from many provincial Coach-builders, they hope, that being able to show that they have now started the Institution fairly, with an almost positive certainty of its permanence; and having been able to relieve many cases of distress in the provinces, they may look forward in future years to a more hearty support from the Coach-builders residing away from the metropolis.

"It was considered desirable, previous to the First Anniversary meeting, to solicit subscriptions only from Coach-builders, and those closely allied to the Trade, as a test of its receiving their cordial support; but that time passed. The Committee consider it will be desirable to ask support from those persons who are almost as intimately interested in the welfare of the Trade as those actually practicing it, who derive their profits from it in furnishing the materials, and are benefited, or otherwise, as it is prosperous or depressed. They also trust to receive support for the Institution from charitably-disposed members of the wealthy classes using carriages, whose comfort has been promoted by persons who have since fallen into a state of distress. As it was the anxious desire of the Committee to render the Institution permanent and prosperous, they consider they could not better promote its stability than by proposing, at the general meeting in June, that all sums received should be funded till £2000 stock could be secured. They were fortunately able to do this several months past; and from the sums since received, they have been able to relieve several urgent cases of distress. It has been decided to elect Four Annual Pensioners, for the receipt of your bounty, at this First Anniversary meeting; and it is hoped that as the Society becomes better known and appreciated, they may be able to increase the number of Annual Pensioners. Eight Candidates are submitted, whose cases have been carefully and thoroughly examined by the Committee, in accordance with your Rules. They all testify to the want that has existed for such an Institution, and how welcome such assistance as you can give will be to those who have seen better days.

In submitting the statement of receipts and expenditure, your Committee have carefully avoided any expenses which might be unnecessary; the charges for the first year in printing Circulars, Books of Rules, &c., &c., may appear to you somewhat heavy, but they feel it is as low as it could be, keeping in view the properly-establishing of this Institution; and, that as it has now become one of the settled institutions of the country, the expense, though unavoidable, will not be again necessary. The statement submitted by the Committee, they hope, will be approved by the meeting. It has already been examined and certified by the Auditors, in accordance with the Rules. Your Committee will propose for your sanction a few alterations in the Rules, and that there be four Classes of Pensions, viz.: £25, £20, £15, and £10 per year, and that the amount each Candidate shall be eligible to receive, be determined by the Committee before the day of Election."

The total receipts, during the first year, amounted to £2029 11s 1d, the larger portion of which were donations to the Institution.

Annual subscribers of one guinea, or donor of ten guineas

in one donation, are constituted governors, and entitled to vote and take part in the proceedings at the general meetings, and in the election of the committee. At all elections of applicants for relief, subscribers of one guinea annually have one vote, and an additional vote for each guinea annually subscribed, or for each donation for ten guineas.

The third annual meeting was held on the 22d of February last, the Right Hon. the Earl of Shelburne in the Chair, the proceedings of which have not yet come to hand. The list of applicants for relief, in January last, amounted to ten—3 males and 7 females, aged from 41 up to 65. Such is the brief history of an Institution in England, which cannot fail to soften the rigors of the winter of life of many an unfortunate and needy pensioner.

#### A LADY'S OPINION OF OMNIBUS PASSENGERS.

A FEMALE correspondent thinks that the world is full of heathens; that we need not go to China or Japan to find them. She says, "you need not even leave our fashionable thoroughfares, if you wish to see them; but come with me some fine morning and take a walk in Broadway."

"You have on a new suit of broadcloth, and I a fresh supply of millinery, &c. A sudden shower comes up; we wait under an awning for a stage; one passes—the very one we want; the driver is looking the wrong way, and does not observe our signal to stop; but the passengers are looking out—they see it—yet no one pulls the strap. There are heathens in that stage. Another comes along; this time the driver sees and stops; he thinks, in the rain, people will be a little considerate, and take in one extra passenger, even with a little crowding. But he is mistaken; they shout 'full' to us as we advance to the step. There are heathens in that stage. We return to the kind shelter of the awning, and the rain comes down by this time in good earnest.

"Another stage—this time there is or should be room for both you and me—for there are but five on each side, yet as you open the door and I enter, all glance at me with cold curiosity; but I see no vacant seat; some sit sideways, some with hoops outspread, occupy two seats instead of one, and only when I show a determination to sit down in some particular spot, does any one move at all, while you are hanging on at the outside, unable to enter at all. Sir, there are heathens in that stage, too. Now, the fact of your new broadcloth and my new bonnet, dress, and mantilla being ruined make it the more provoking; yet it would still be the duty of the passengers to make room for us, though we were ever so plainly dressed—yes, even though we were ragged and dirty; for, are the stages not public vehicles? Does any one pay for more than one seat? It is high time there were tracts published on 'Omnibus Morals,' and circulated freely among the passengers, that he who rides may read. The plan would put money in the pockets of the Companies, as well as decency in the behavior of the public.

"I well know that my own sex are the worst transgressors in these things. Many a time have I been the only woman in eleven who moved at all to make room for a twelfth (though I wear as big a hoop as any of them.) Shall the

heathen be converted, or will the public utterly ignore the command: 'Whatsoever ye would that men should do to you, do ye even so to them.'

The complaints, made by the writer we have quoted, would naturally be suggested to any one who might be looking for "a stage" on a rainy day in New York, notwithstanding there are so many omnibusses, rail-ears, &c. We have ourself stood so long looking for a chance to ride, in rainy weather, that our patience became exhausted and we were finally compelled to "foot it." Notwithstanding this, we do not think, that because people know enough to get into an omnibus, they ought to be branded as heathens. The act, in our mind, argues them to be directly the reverse. We think that this is about the first instance we have heard of, where there has not been, in a stage, "room for one more," and for the novelty of the circumstance, we have taken occasion to place the fact on record.

#### OUR AUTHORIZED AGENTS.

WITH this Number we send out several agents, one of whom will visit our friends in the Eastern States, and another New Jersey, Pennsylvania, Western New York, and the Canadas. These will all be furnished with a quantity of receipts with our engraved signature, and a good supply of Magazines, to supply our subscribers with at the time of subscribing. Any one who comes along with a few Numbers, offering to supply our Work for less than our advertised rates, and for less than a year, and, especially, should he not be able to show a certificate of authority, in our handwriting, may be deemed an imposter. We bespeak for our agents the cordial support and kind reception of the craft generally.

#### FAMILIAR LETTERS FROM THE CRAFT.

MEDINA, OHIO, April 24, 1859.

FRIEND STRATTON—We have had a very wet Spring thus far, and the roads are very bad. Yesterday, we had a regular Northern snow storm; but to-day the sky is clear, and we hope the weather will be fair, so that the farmers may start their ploughs, as the success of all manufactures, in a great degree, depends upon the prosperity of the farmer. Carriage manufacturers in this locality are all looking for the good time coming, when the roads shall be good, and the people want to ride. The wool and dairy prospects are good at present in these parts, and we hope for ready sales of carriages this summer.

I think the craft have reason to be proud of our Magazine, and that they are in duty bound, to themselves and their families, to see that it is well sustained; and, as the times improve, I hope your subscription list will be extended. Here let me make a suggestion to carriage-makers. Where you wish to preserve your Magazine for binding, make a present of a copy to your apprentices. You will lose nothing by it in the end; it will cultivate a taste for reading, which will have a tendency to improve their minds; and the more they are encouraged, the more they will feel

interested in their work, and will, consequently, be more profitable to their employers.

A few words to apprentices; and I ask every subscriber to let them read this. If you want to make respectable, influential business men, you must cultivate a love for reading. Instead of spending your evenings at the grocery, or tavern, drinking beer and smoking cigars, save your money; and, with what is usually spent by boys in this way, you may subscribe for from three to five good newspapers, or other periodicals, and, besides, have plenty of time to read them. You do not now, perhaps, realize the benefit you would derive from such a course, nor cannot, until it will be too late; therefore take the advice of a solicitous friend, and act accordingly.

Where is the apprentice boy that cannot spare one dollar to subscribe for a newspaper? You will find elubs of the best weekly paper, wherever you find a carriage shop. Here let me remark, that the laboring classes are more indebted to Horace Greeley, for cheap reading, than any other man in the world. I do not say this, because I agree with him in politics, for I do not, although I have been a constant reader of his paper for many years. When boys become interested in political matters, and become more or less conversant with the principles of all parties—as they should be in these times—they cannot fail of making better citizens, when they come to be men, and, also, be better qualified to judge of political questions. Let a young man take the *Tribune* for instance, or some other good weekly publication, and read the history, biography, travels, and general news therein contained, for a series of years, and he will pass for a well-informed man in any society. If, among the hundreds of boys who may read this, there shall be one that is persuaded to leave off any of the habits I have mentioned, and follow the course I have recommended, I shall feel amply repaid for the time spent in writing this. What is it that gives some men a higher standing in society than others? Is it not the cultivation of their moral and intellectual faculties in early life? I long to see the time when mechanics shall try to elevate themselves—when they will occupy their true position in society—when working, reading, and thinking will be done by all men, instead of the larger portion spending all their time at work, to support a favored few to read and think for them.

Yours, respectfully,

E. BRIGGS.

NEWARK, N. J., April 26, 1859.

MR. EDITOR—*Dear Sir*: I notice in your Magazine an advertisement of a patent, which has, probably, been the cause of more trouble and excitement than any other patent about a carriage. It is termed Hausknecht's patent carriage coupling, and, I perceive, he also publishes a decision in a suit in New Orleans, in which Marsh, Denman & Co. were defendants, and which, I understand, he makes a great handle of as establishing his right as patentee; and, by such means, he goes about the country endeavoring to make those who have bought the right to use Everctt's coupling, and have manufactured under that and no other, believe that they are infringing upon his rights. He threatens all kinds of vengeance, if they do not settle with him for what they have already made, or else purchase the right of him. I learn, furthermore, that in many instances he has succeeded in frightening various sums out of different persons, and I consider it to be no more than a species of blackmail. To make his success more certain, he has threatened many, that he would at once institute suits against them

for damages, but he finds there are some not to be frightened by him. I have yet to learn of the first suit being brought to trial. I believe he is fully aware that he could not sustain his case, and then his occupation would be gone, and his present mode of procuring a living would cease, and he be compelled to seek some more respectable business for a livelihood.

I understand that the case in New Orleans is only an injunction, restraining the Denmans from selling any carriages with the coupling on, such as they had used for some years, and if I am not wrongly informed, before the date of January, 1852, and that the case is to be again tried.

If it could be tried here, at the north, where there are hundreds of mechanics, that are conversant with Everett's patent, and never knew of any other, until this man impudently pushed himself into notice, I tell you, his blackmail business would soon come to an end. It can be proven—and I would refer you to Ure's dictionary—that the same principle was in use years before, and the Patent Office refused to grant him a patent, because they discovered there was a patent in France for about the same thing. It was also told him that his was an infringement upon a patent they had granted to Chas. & Edw. Everett for the same purpose, and they could not grant it unless he altered his specifications, and likewise made his model conform to it, so as to have the combination of the double set of segments, one set above and the other below the spring, as fully explained in his letters patent, dated January 13th, 1852, and as is also shown in his model, now in the Patent Office (a duplicate of which I have seen), on which he obtained his patent. No one could or would use it at all, as it is not at all practicable, and nothing like Everett's patent, which has been applied and used by most of our carriage-makers, and known as Everett's patent long before they ever heard of any other. I am only surprised that any well-informed men (and I think that carriage-makers generally are such) will permit themselves to be humbugged by such a man. In fact I learn that there are several who have paid him to get clear of him, and avoid being annoyed by one they despise, who now say they regret having done so. There are others who say it will not be well for him to visit their shops, as he has frequently done in their absence, to spy out if they are making, what he has the assurance to term, his patent. If they have no better opinion of him than I have, he would not come the second time to the same shop.

There are many more things I might say for the benefit and information of my brothers in the craft, but will not at this time; but I may give more facts when I have more time. I wish your Magazine success. The business of carriage-making has grown very much in our country in a very few years (and I am proud to say I believe my fellow carriage-makers will bear me out in the assertion), so that it is second to few, if any, of the mechanical arts of this our free and independent land. More anon.

A BROTHER CARRIAGE-MAKER.

NEW CITY RAIL-CAR IN PHILADELPHIA.—There has been introduced on one of the City rail-tracks in Philadelphia, a new style of railway car. It is constructed with a swell body, so that it gives six inches more width between the seats than in the old Cars on the same line, and yet weighs 1,600 pounds less, costing no more.

## INVENTIONS APPERTAINING TO COACH-MAKING AT HOME AND ABROAD.

### AMERICAN PATENTED INVENTIONS.

March 22. METHOD OF SECURING BITS IN THE STOCK.—William Tucker, of Blackstone, Mass.: I claim the application or arrangement of the screws, &c., and the segmental button *g*, with respect to the bit, or boring tool socket, and to operate with or on the tool substantially as specified.

MACHINE FOR HEADING BOLTS.—B. C. Vanduzen, of Cincinnati, Ohio: I am aware that toggles have been used for operating punches, dies, etc., and arranged in various ways, and I therefore do not claim, broadly, the use of toggles for operating the heading die *F*, and die *j*.

But I claim the arrangement and combination of the adjustable spring fork rod *G*, lever *H*, upper lever *b*, and heading die *F*, substantially as shown and described, for the purpose of regulating the movements of the lever *H*, and die *F*, and controlling the size given to the head of the bolt.

ODOMETER.—Haskel Walker, of Hartford, Ct., (assignor to himself and B. P. Driggs of Fairlee, Vt.): I claim the peculiar arrangement of the parts thereof, by which an actuating tooth upon the hub of one of the wheels of a carriage will cause each revolution of said wheel to unerringly impart a small portion of a revolution to the shaft *K*, of the Odometer whilst the spring *l*, by its action against the faces of the angular position of said shaft, will accurately govern and control the movements thereof, substantially as set forth.

Third, making the elevis adjustable for the purpose of adapting it to the use of different sized segments in the same machine, as described.

March, 29. CARRIAGE TOPS.—Pardon Boyden, of Sandy Creek, N. Y.: I claim the arrangement and combination of the bows *E*, bars *DD*, bars *HH*, and seat rail *a* substantially, as, and for, the purpose shown and described.

MACHINE FOR BENDING TIRE.—Wm. Patterson, of Constantine, Mich.: I do not claim the method of bending tire by means of the segment lever and clevis, neither the combination of these elements as they exist in the patent of Aaron Whitcomb.

But I claim connecting the clevis to the lever and segment in such a manner, that the lever will cause the clevis to grasp and release its hold on the bar to be bent, independently of, and before said segment commences to move, as illustrated by the red lines in the drawings.

Second, providing the outer end of the clevis with an arm *L*, *v*, so arranged, in relation to the circumference of the segment, as to bear against the outer side of the tire, and support it (while being bent) above the end of the segment as represented, thereby preserving the circle of the tire by preventing it from springing back during the descent of the lever.

FORGING MACHINE.—Erhard Sehlanker, of Buffalo, N. Y.: I am aware of the revolving forging machine of D. Noyes, of Abington, Mass., and of attaching the hammer or hammers, each by a pivot, to a revolving disk or crank, so as to revolve therewith, and controlling the position thereof, by stops attached to the face of the disk, or crank, and of drawing the hammer or hammers, lengthwise of the anvil; which I disclaim, as being original in principle but defective in operation, by the use of the stops affixed to the disks, or imaginary crank.

I claim that portion of the hammer shaft *QQ*, from the center pins *vv*, extending toward the driving shaft *W*, to be used as a lever, in controlling the hammers *DD*, the center pins *vv*, being the fulcrums, in connection with the wrists and friction rollers *YY*, and *XX*, the location and position of the spring cams *SS*, upon the duplicate face plates, *F a F b*.

The sections *EE*, and the independent operating crank cams *RR*, guide plate *a*, cranks *hh*, levers *c* and *f*, connecting rods *d d u*, as described in the specification.

MANUFACTURE OF WOOD SCREWS.—N. G. Thorn, of Cincinnati, Ohio: I do not confine myself to any particular form of construction as to size, shape, &c., as these may be varied indefinitely, and the same construction is applicable to coach or lag screws, or any other screw in which wood or other yielding

substances constitute the material into which the screw is driven.

I am aware that a tapering screw point has been long used upon augers, gimblets, &c., and I, therefore, do not claim that feature as any part of my present invention.

But I claim, as a new manufacture, the described wood screw, the characteristic feature of which consists in its having two or more parallel threads that terminate at or near the point of a tapering core, substantially as described.

**MACHINE FOR ROLLING WHEEL TIRES.**—Nathan Washburn, of Worcester, Mass.: I claim the combination of a set of reducing rollers A B, a series of adjustable carrying rollers, *d d*, &c, or their equivalents, and a frame or holder G, supported so as to be capable of rising upward within the wheel tire in proportion as the diameter of the inner periphery of the said tire may increase, during the process of rolling the tire, and having the said carrying rollers arranged and made adjustable with respect to it, and the reducing rollers, in manner substantially as specified.

**SAW-SET.**—Olive Ann Brooks, of Great Falls, N. Y., administratrix of the estate of Lebbeus Brooks, deceased, late of Great Falls, aforesaid: What is claimed as the invention of the said Lebbeus Brooks, is the arrangement and application of the benders and bending screw together, and with respect to the two handles, substantially as set forth, whereby the center of motion of the benders is at the place of contact, or the vertex of the angle of their upper surfaces, and no fulcrum pin is employed for the support and connection of the levers.

April 5. **MODE OF ATTACHING HORSES TO VEHICLES.**—E. D. Lockwood, of Penfield, N. Y.: I am aware that horse collars have been constructed with a breast strap and back strap, arranged similarly to the straps B C, shown, and I do not claim, separately and broadly, said straps, as a horse collar.

But I claim attaching the strap B, to the thills A A, by means of the perforated plate *c*, and the pins *f*, placed in the recesses *e*, of the thills, and having wide and narrow parts 1 2, substantially as described.

**KEEPING AIR-SPRINGS SUPPLIED WITH AIR.**—S. G. Randall, of Middlebury, Vt.: I claim combining an air-spring and an air-pump, or its equivalent, with a car or carriage, or other moving conveyance, as that the motion of said car, carriage, or other conveyance, shall, through such air-supplier, keep the air-springs supplied with air, substantially as set forth.

**TRACE FASTENING.**—Anthony Zink, of Lancaster, O.: I claim a new article of manufacture, to wit: a trace fastening, consisting of the metal ferrule B, provided with a circular groove E, running in path of a vertical circle, and two slats, *a a*, running at right angles to the groove, and a metal cap Y, having two lugs *c d*, on its inner circumference, with a space existing between them and its head, and a plate *b*, extending from the circumference of the head some distance into the side of the trace, all as set forth.

**HUB BORER.**—Cutting B. Wiley, of Adrian, Mich., assignor to himself and Alex. Stebbins, of Lenawee Co., Mich.: I claim the combination of the sliding cutter head G, with the adjustable ways or slides E, with the nut K, and screw C, the whole being arranged and described, for the purpose set forth.

April 12. **ATTACHING THILLS TO VEHICLES.**—Douglas Bly, of Rochester, N. Y.: I do not claim the hook form of the block D, nor the mere use of a shoulder to sustain the pressure of the thills, or pole, in backing, in any other connection.

But I claim the construction and arrangement of the movable piece or block E, having the notch G, and a screw shank in half, and slightly wedge-shaped, in combination with the oblique shoulder H, on the notched screw shank R, and with the hook J, of the block D, substantially in the manner and for the purposes set forth.

**GUIDE ATTACHMENT FOR VEHICLES.**—Nathl. Drake, of Newton, N. J.: I claim the slotted pole strap bar F, and catch G, placed on and connected with the draft pole D, respectively as shown, in connection with the cords *c c*, attached to the catch G, passing through the uprights E, and shieves *d d*, of the horse collars, and attached to foot levers H H, or their equivalents, substantially as and for the purpose set forth.

**JOINT-BODIED BUGGIES.**—Edwin J. Green, of Valparaiso, Ind.: I claim connecting the front axle of a carriage to the body by means of a swivel-joint, composed of shaft G, king-bolt E, turning-plate D, and stationary-plate C, when the latter is secured directly to the body of the carriage, substantially in the manner and for the purpose described.

I also claim connecting the front springs to the coupling or reach by means of the shafts G, which is welded, or otherwise secured, to said springs, as represented.

I also claim, in combination with a hinged carriage body, the braces, P and Q, for the purpose of preventing the rear axle from being thrown angling when the carriage is loaded heavier on one side than on the other, substantially in the manner described.

**HORSE COLLARS.**—Thos. Harvey, of Baltimore, Md.: I claim the arrangement of the parts forming the body of a horse collar, and the construction of an underback in such form as that the outer edges of the underback, and the face of the collar, and the outer back are all made perfectly secure by an under seam, and at the same time the under seam is hid from view and wear, as also showing the stitched edge of the outer back in its proper place, all being accomplished previously to the filling of the collar, instead of putting on the outer back after the collar is filled, as in the manner in putting together a case collar.

**HORSE COLLARS.**—Thos. Harvey, of Baltimore, Md.: I claim the construction and addition of a fancy welt to a welted horse collar, the same being perfectly adapted to its location, being along side of the usual welt, and so formed as to bring it directly down on the face of the collar, and thus showing a stitched edge, as also being in the proper place to prevent the hame-tug from cutting into the collar, as set forth.

April 19. **MACHINE FOR FILING SAWS.**—A. M. Beardsley, of Elkhart, Ind.: I do not claim a swinging frame, either for supporting the file or the file carriage, neither do I claim lifting the swinging frame and file, so as to clear the teeth of the same by means of a spring, or any other device, so that the same can be fed beneath the file, as each tooth is sharpened. But I claim, first, the arrangement of the swinging frame of the file carriage upon the adjusting plate E, so that it can be turned over and supported upon the bed plate A, in the manner and for the purposes described and shown in the drawings.

Second. The arrangement of the check pieces N, upon the adjusting plate E, between the arms of the swinging frame, for the purpose of bracing the latter against the thrusts of the file carriage, while said frame is free to rise and fall, as described.

Third. The arrangement of the gauging screw M, in the cross-piece H, of the swinging frame, by which the teeth are filed to a uniform depth, without interfering with the rising of the file carriage, to conform to the taper of the file, as described.

Fourth. The arrangement of the seats, *a a*, at each end of the bed plate A, whereby the implement may be supported directly upon the clamp of the saw, or the purposes described.

**IRON CARRIAGE WHEEL.**—John D. Murphy, of Baltimore, Md.: I am aware that combined cast and wrought iron wheels have been constructed before, and I therefore wish to be distinctly understood as disclaiming the invention and construction of such wheels, broadly considered.

But I claim a combined wrought and cast iron wheel, when the several parts composing said wheel are constructed in the form and arranged and combined in the order, as and for the purposes shown and described.

I also claim having the entire rim *d*, of the tread of the wheel open at one place, as shown at *d*, until after the hub is cast, in combination with the mode of inserting and fastening the spokes in the rim or tread of the wheel *d*, as and for the purposes described.

**ATTACHING THE RAILS OF CARRIAGE SEATS.**—Cornelius Scofield, of Trumbull, Conn.: I am well aware that rails have heretofore been attached to carriage seats by arms attached to seats, in a manner very similar to mine, and each provided with jaws which project over the rail, so that screws may be placed in those parts of the jaws before the rail in order to secure the



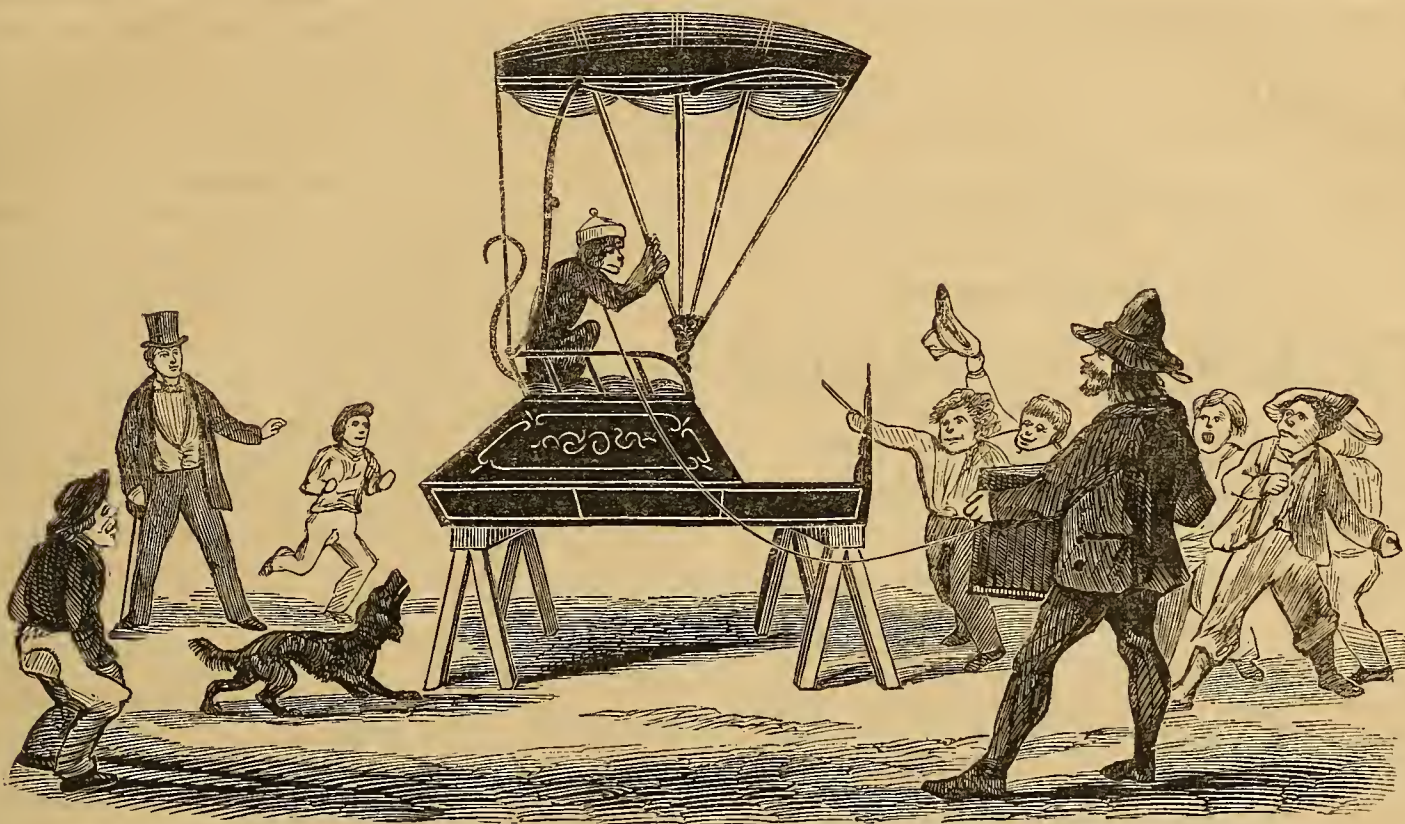

same. In this ease, however, it was necessary to remove a large number of screws, in order to be able to remove the rail. I do not claim, therefore, the manner of securing the rail to the seat by means of arms and screws.

But I claim the arrangement of the arms *a*, the ends of which form half round recesses *d*, in combination with the arms *C*, and thumb serew *k*, for the purpose of supporting the rail and securing the same to the seat, in the manner substantially as set forth.

#### RECENT EUROPEAN PATENTED INVENTIONS.

December 1. Henry Bessemer, 4 Queen Street Place—New Cannon Street-Improvements in railway and other wheel and wheel tires.

December 21. Robert M. Livingston, Manchester—An improved self-detaching "safety-hook" or coupling.

William Mainwaring, Brunfield, Herefordshire—Improvements in brakes for common road vehicles.

December 24. Alfred Smith, Humbleton Hall, Yorkshire—Improvements in gigs, dog-earts, and other vehicles.

Rafello L. Giandonati, St. Paul's Church-yard—Improvements in ornamenting leather cloth.

December 27. Henry Lowe, William Trueman, and John L. Pitts, Birmingham—A new or improved axle for earriages.

December 31. John H. Sievers, 48 Rathbone Place, Oxford Street—Apparatus for tightening and releasing the belly-bands of riding saddles.

Louis A Normandy, 67 Judd Street—A new system of shaft-tugs.

January 1. William Footman, 15 Water Street, Strand—Improvements in brakes for retarding and stopping railway trains, carriages, or other vehicles.

Pierre E. Guerinet, 60 Boulevard de Strasbourg, Paris—Improvements in the application of an apparatus to railway locomotives, wagons, and carriages, for the purpose of lessening the effect of concussion in the event of collision.

January 4. Charles de Forest, Leicester Square—An improvement in the manufacture of springs for carriages, and other uses.

January 18. Henry Gaalon, Joseph H. Bean, and Samuel Lumb, Leeds—Improvements in machinery for slotting, mortising, tenoning, and cutting wood, iron, and other substances.

#### ORIGINAL IDEA FOR A TOP-LIFTER.

Ours is an age of inventions; but the above display of our artist takes the shine out of everything heretofore discovered, always excepting *that* top-lifter "west of the Alleghanies," which for two or three years has intruded itself upon the public. Could that splendid and *original* conception have been suggested by *natural* ideas? We pause for a reply.

AN Eastern Editor says that a man got himself in trouble by marrying two wives. A Western Editor replies by assuring his contemporary that a good many men in that section have done the same thing by marrying one. A Northern Editor retorts—quite a number of his acquaintances found trouble enough by barely promising to marry without going any further. A Southern Editor says that a friend of his was bothered enough by simply being found in company with another man's wife.

As my wife, at the window, one day,  
 Stood watching a man with a monkey,  
 A cart came by with a "broth of a boy,"  
 Who was driving a stout little donkey:  
 To my wife I then spoke, by way of a joke,  
 "There's a relation of yours in that earriage."  
 To which she replied, as the donkey she espied,  
 "Ah, yes, a relation by marriage!"

A PROBLEM FOR MILKMEN.—If twenty-seven inches of snow give three inches of water, how much milk will a cow give when fed upon turnips? Multiply the flakes by the hairs on the cow's tail, then divide the product by a turnip, add a pound of chalk, multiply the whole by the pump, and the total will be the answer.

AN Irishman, who was very near-sighted, and about to fight a duel, insisted that he should stand six feet nearer his antagonist than he did to him, and that both should fire at the same time.

## PROSPECTUS OF THE SECOND VOLUME.

The only Magazine of the kind in existence!

A NEW VOLUME COMMENCES WITH THIS NO. FOR JUNE,

OF

THE NEW YORK  
Coach-Maker's Monthly  
MAGAZINE;

DEVOTED TO THE LITERARY, SOCIAL, AND MECHANICAL  
INTERESTS OF THE CRAFT;

Embracing Four Beautifully-engraved Plates, on Tinted Paper, useful to Coach-Makers; Twenty Pages of Interesting Reading Matter, Illustrated with Fine Wood Engravings, with the necessary Cover and advertising pages to render the work complete.

To those who have so generously patronized our Magazine in its infancy, and through a season of unexampled business prostration, we take occasion here to return our heart-felt thanks. We think it scarcely necessary to say anything in order to persuade them to continue their subscriptions into a SECOND VOLUME. We rely with confidence on their continued patronage. But there are yet many who are unacquainted with the object and character of this publication. To reach such we depend upon our generous friends, hoping that they will extend their liberality so far as to invite their acquaintances to give us "a lift" the ensuing year.

The Publisher would say to all, that he intends to spare no pains in striving to make this Magazine useful to the coach-maker in his *work-shop*, and, in some degree, at least, to instruct and amuse the members of his "*Home Circle*."

The general features carried out in the first volume will be maintained in the second, with an aim, so far as the mechanical departments are involved, to make it still more worthy of the craft. We have some new and interesting features in contemplation for the future, which we choose to give in performance rather than in promises. Some tell us (we would say this modestly), we have more than redeemed our promises in the past. We hope to deserve as much credit in this volume.

PLAN OF THE WORK.

OUR MONTHLY DESIGNS will consist of three PRACTICAL WORKING DRAFTS, contributed by first-class designers and reporters of Style, both in this country and in Europe, and drawn correctly to scale. To enlarge the field of design, and to give variety and tone to the work, we shall (as a general thing) give one foreign, one fashionable, and one original or improved design, in each number. To accomplish this, we have secured Paris, London, and Berlin Correspondence; also some of the most eminent designers in this country.

AS A LITERARY WORK, we design to make the "COACH-MAKER'S MAGAZINE" an honor to the Craft.

OUR PORTRAIT GALLERY.—We shall give an occasional Por-

trait of men, eminent as Manufacturers, intimately connected with Coach-making.

Many of the first Coach-makers in America have arisen from poverty and obscurity to their present position, with no other help but native genius and an indomitable will; such life sketches cannot fail to inspire the hearts of the rising generation with a nobler and higher purpose of life.

THE BUSINESS DEPARTMENT will contain matter of a purely business character, such as Patent Illustrations, Notices, Items, &c. In this we shall speak of inventions as they are represented, and of business in the light best calculated to bring our advertisers into notice; so that all remarks of a complimentary character must be regarded in a *purely business light*.

THE TRIMMING ROOM will be open to contributions, but will contain prospective cuts only when some new and practical design is discovered, or some new fashion is introduced; but will contain hints and suggestions from the most eminent workmen, East and West, with diagrams, scientific rules, &c., illustrated and explained. A quarterly Stitching Plate will be given.

THE PAINT ROOM.—The Painters' department will also be supported by voluntary contributions, and will contain "hints," facts, valuable receipts, &c. The Ornaments will be of a rare and tasteful character, and will appear on a fine tinted plate leaf, quarterly. Printing them thus will secure a finer impression than otherwise.

THE SMITH SHOP.—The Iron Workman will find his branch ably represented in this department.

For terms, &c., see on first page of the cover.

Please make up your clubs, and send on your subscriptions, with *the payment in advance*, that we may have some guide as to the edition that will be called for.

CERTIFICATES.

As we knew the man we had to contend against when we undertook this enterprise, we fortified ourselves with "the documents." Circumstances have since shown the wisdom of the measure. We now add a few additional names, in order to satisfy those Southern and Western friends, who were so shamefully treated by "their old friend" in 1858, that by giving their patronage to us they are dealing with quite a different character. We could multiply these certificates almost indefinitely, did we consider it necessary. If further evidence is wanted, we offer the fact of our promptness in issuing the numbers of the first volume.

1009 CHESTNUT ST., PHILA., 10th Nov., 1858.

This is to certify that I have always found Mr. E. M. STRATTON, Publisher of the "NEW YORK COACH-MAKER'S MAGAZINE," a gentleman of worth and reliability, and cheerfully recommend him to the notice of all engaged in the Carriage business.

WM. D. ROGERS.

SALEM, OHIO, March 4, 1859.

Having been personally acquainted with Mr. E. M. STRATTON for several years past, and knowing the high reputation enjoyed by him as a responsible man, a practical Coach-maker, an accomplished scholar and a gentleman, I take pleasure in saying that I have full confidence in his ability to make the "COACH-MAKER'S MAGAZINE" all the craft may desire. I therefore cheerfully recommend Mr. STRATTON as worthy of the patronage of the Coach-making public.

ALLEN S. FELCH.

To the above we subjoin the certificates of the leading men in the trade in New York city, and who have known us for years:

This is to certify that we have been acquainted with E. M. STRATTON, Proprietor of the "NEW YORK COACH-MAKER'S MAGAZINE," for several years, and we believe him to be not only a correct business man, but perfectly responsible as a publisher. We intend to give his new enterprise our hearty approval and cordial support.

COACH-MAKERS—NEW YORK CITY.

WOOD BROTHERS, J. R. LAWRENCE & CO.,  
BREWSTER & CO., MINER & STEVENS,  
DUSENBURY & VANDUSER, JOHN C. HAM.

CARRIAGE HARDWARE DEALERS—NEW YORK CITY.

SMITH & VAN HORN, JOHN P. JUBE, BOUTON & SMITH,  
F. S. DRISCOLL & CO., CHARLES C. DUSENBURY.





BRAECK.— $\frac{1}{2}$  IN. SCALE.

*Engraved expressly for the New York Coach-Maker's Magazine.—Explained on page 80.*

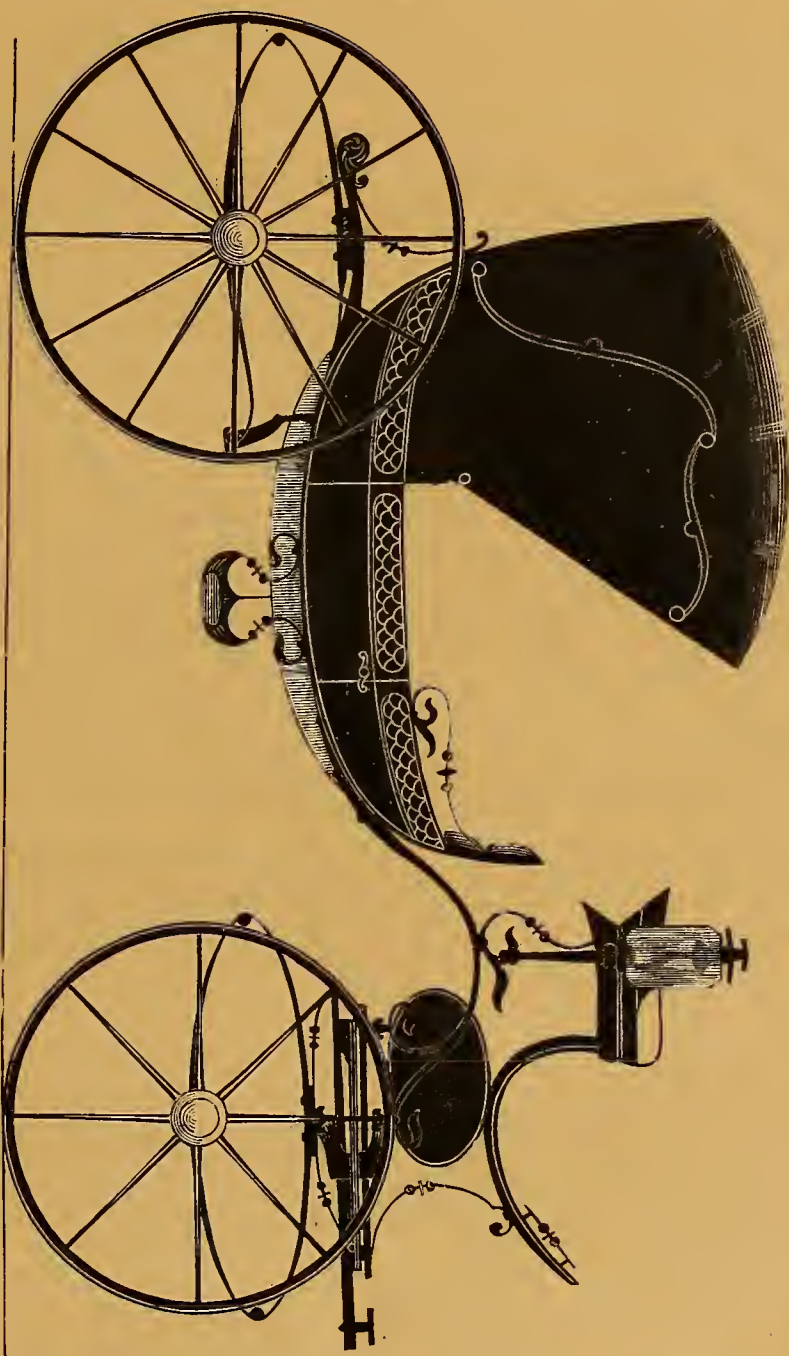

SINGLE TOP BAROUCHE.— $\frac{1}{2}$  IN. SCALE.  
*Engraved expressly for the New York Coach-Maker's Magazine.—Explained on page 30.*







BUGGY WITHOUT A PERCH.— $\frac{1}{2}$  IN. SCALE.

*Engraved expressly for the New York Coach-Maker's Magazine.—Explained on page 80.*





*Your Friend*  
*John Deere*

*Engraved expressly for the New York Coach-Maker's Magazine.*

**JULY, 1859.**





DEVOTED TO THE LITERARY, SOCIAL, AND MECHANICAL INTERESTS OF THE CRAFT.

Vol. II.

NEW YORK, JULY, 1859.

No. 2.

## The Coach-Maker's Portrait Gallery.

For the New York Coach-maker's Magazine.

BIOGRAPHY OF JOHN C. DENMAN, Esq.

(WITH PORTRAIT.)

In presenting our readers this month with a portrait and brief biographical sketch of this distinguished member of the trade, we can only promise to furnish a small portion of the prominent events of his life; but these, we trust, may furnish abundant material to strengthen and encourage all who are striving for eminence and fortune, no matter how adverse circumstances may appear.

"Things, done well, and with a care,  
Exempt themselves from fear."

Living examples of persevering industry and indomitable determination, "that command success," are of infinite benefit to the young and inexperienced.

"There is a history in all men's lives, figuring the nature of the times deceased;  
The which observed, a man may prophesy, with a near aim, of the main chance of things as yet to come to life;  
Which, in their seeds and weak beginnings, lie intreasured.  
Such things become the hatch and brood of time."

JOHN C. DENMAN was born in November, 1815, in the township of Westfield, Essex county, New Jersey, on a farm belonging to his family since the first settlement of the State, which was purchased of the aborigines at the nominal price of "six cents" per acre. This homestead is still in the possession of his mother, and upon this farm he labored, when not attending the neighboring country school, up to the age of about sixteen and a half years.

The advantages of schooling being quite limited in such localities, his early opportunities were hardly equal to those of children in New York at the present time; but such as they were, they were improved by him to the best of his abilities, when not "especially" engaged in boyish pranks, of which it is said he "cut up" his full share.

At the age of sixteen and a half years he was apprenticed to Charles Hedenberg, of Newark, N. J., to learn the art and mystery of body-making, where he served his full term of apprenticeship.

Soon after his majority, he commenced working at the shop of his uncle, Ralph Marsh, at Rahway, N. J., and while

there, made the first paneled coach-body ever got up at Rahway. He continued in the employment of his uncle one year, but the disasters of 1837 having now overtaken all branches of trade and commerce, and wages being so seriously depressed, he was induced to pack up his chest and start in search of more remunerative employment; and if that could not be obtained, he would have the advantage of seeing and learning the "ways of the country." No satisfactory opening was found until he reached Columbus, Ga., where he engaged, and took charge of a large carriage-shop for Mr. George W. Way, remaining one year. At the expiration of this time he returned on a visit to his native place, and remained a short time. Toward spring he went to New Orleans, and worked until the yellow fever broke out with such unusual virulence that he was obliged to leave that city. Having now determined to remain at the South, he went into the State of Mississippi, and worked that summer for planters, in reconstructing and repairing cotton-gins, at carpenter work, and getting out frames for buildings. As soon as the city was sufficiently healthy in the fall, he returned to New Orleans in search of employment, but, not succeeding to his expectations, went to Mobile, Ala., and procured a situation for one year at his trade. His little earnings had been carefully saved, and sent home for investment; his stock of knowledge had increased with his experience, and nothing was allowed to escape his observation that might be turned to useful account hereafter. Attached friends sprung up around him, who still point with satisfaction to their first and early acquaintance.

The succeeding fall he returned to New Orleans, and made the acquaintance of Mr. John E. Matthews, with whom he formed a business connection in manufacturing and repairing carriages, which was continued the succeeding ten years; and this was probably as agreeable and harmonious a business connection as ever existed between two persons, during the entire period of its continuance.

At the commencement of the Mexican war, this firm of Matthews & Denman had large contracts with the General Government for furnishing the army, which resulted satisfactorily to all concerned. Their business having increased very considerably, they were induced to purchase a large property on Gravier and Carondelet streets, upon which they erected three large brick fire-proof stores, considered at that time second to none in the city.

In the spring of 1852 he retired from business, feeling that he had accumulated a reasonable competency, but, in a very brief period, found that inactivity was "unconstitutional," and that it was preferable to wear than rust out.

Toward the close of 1852, he connected himself with his brother, J. Marsh Denman, under the firm of J. Marsh Denman & Co., at New Orleans, and Denman & Co., at Rahway, N. J., he taking charge of the business at the North, and his brother, of that at New Orleans. This connection existed four years, and during this period the New Orleans house probably disposed of double the number of carriages of any other concern in the Union.

"If we stand still in fear, our motion will be mock'd or carped at: We should take root here where we sit."

In July, 1856, he purchased the interest of his brother, J. Marsh Denman, in both the New Orleans and Rahway establishments, and associated with him a younger brother, under the present firm of R. Marsh Denman & Co., at New Orleans, and Denman & Co., at Rahway, N. J.

"His training such, that he may furnish and instruct great teachers, and never seek for aid beyond himself."

The extensive and thorough knowledge acquired by him in every branch of the business, from the raw material to the most perfect coach, entitles his judgment to great and deserved weight; and no person is probably called upon more frequently in consultation on the adoption and applicability of improvements and inventions pertaining to carriages; and probably no one person engaged in the business has suggested more real improvements in every department of the trade, except that which is purely imaginary, and in that department all will have to yield to the great poet in his description of Queen Mab's establishment:

"Whose wagon spokes, made of long spinner's legs;  
The cover, of the wings of grasshoppers; the traces, of the smallest spider's web;  
Her whip, of cricket's bone; the lash, of film;  
Her wagoner, a small grey-coated gnat; her chariot, an empty hazelnut, made by the joiner, squirrel, or old grub—  
Time out of mind the fairies' coach-maker."

During the several summers that he resided at New Orleans, he underwent the process of "seasoning"—that is, he had the yellow fever twice; and to try his timber effectually, he had the cholera once, severely; was an active fireman in that city, until incapacitated from the falling of a wall, which broke a leg, and otherwise injured him, from the effects of which he was a long time in recovering.

Since his return to the North, he has taken an active interest in all the improvements tending to the benefit of his place of business.

Among the most important measures adopted by him was the removal of several mill-dams, nearly surrounding what is now the city of Rahway. These ponds of stagnant water had contributed to make the place quite unhealthy—"in reputation" if not in fact. The opposition to the removal of these pestilent ponds was strenuous and bitter, especially among many who were called upon to contribute by way of tax, to remunerate the owners for loss of property. His course was, however, triumphantly sustained by the electors of the district, in electing him their representative in the Legislature of the State immediately after the removal of the ponds. While a member of the State Legislature, he was instrumental in getting a bill through, erecting the new county of Union, which is now one of the organized counties of the State. He is still in

the prime of life, and as full of energy and activity as ever; and that he may long continue his career of usefulness, is the wish of

Yours, &c.

H.

## Miscellaneous Literature.

For the New York Coach-maker's Magazine.

### THE AUTOBIOGRAPHY OF CALEB SNUG, OF SNUGTOWN, CARRIAGE-MAKER.

REVISED BY THE EDITOR.

#### CHAPTER I.

Introductory remarks, wherein Caleb censures some authors for their partiality to the memories of the subjects of their pens—Caleb's birth-place—His maternal ancestry of Pilgrim origin—The Snug family—Caleb's early predilections and his mother's choice—Mrs. Snug chooses a profession for her son—The Sawgetup carriage-maker calls on Caleb's parents in Snugtown—Mrs. Snug's artifice, and Mr. Flatt's serio-comical joke.

"I sate me down, kind folk, to tell a story,  
Of which, I own, the truth *might* be suspected,  
Even by credulous people."

MANY interesting sketches of personal history have been presented to the world by talented writers, some of whom have painted the character of their heroes in such an extravagant strain as to take away all confidence in their narratives. As reflected by these biographers, the virtues of some defunct friend shine with a brilliancy which never was apparent to their most intimate acquaintance. Whether charitably influenced by the classical injunction, *de mortuis nil nisi bonum*—speak not ill of the dead—or by some other considerations less excusable, these productions of interested and admiring friends are found to bear too much the character ascribed to monumental grave-stones; they are great fibbers; the truth appears wholly ignored. The readers of this eventful history, I hope, will exercise sufficient charity to believe that my story differs very materially from that told by the biographers above alluded to. As I shall be addressing my contemporaries, and have no other object to serve but the cause of unvarnished truth, I trust that I shall not be called unreasonable if I ask for my recital a calm and attentive perusal.

In a seaboard town in the State of Connecticut—a place famous for producing wooden nutmegs and enterprising men—I first saw the light. My father, being a "leftenant" in the militia, made our home the rendezvous of the most noted characters of the town—which, being just subsequent to the Revolutionary War, conferred upon any officer above a fourth corporal, great honor. Of the great distinction conferred upon me by birth, as being the son of a military officer, I was entirely ignorant at the time, and as, by the time I had come to years of discretion, the "honor" had, in a measure, become obscured, I have never put forward any claim to noble birth on that account. I am told by my fond mother (who being herself the daughter of a captain in the Revolutionary Army under Washington, whose personal acquaintance, she felt proud to say, her father enjoyed) that at the time of my *babyhood* my neck was so weak that it required the constant attentions of a nurse, to prevent my neck from breaking, but which those who know me now would scarcely believe, when they see how stiff I carry that appendage.

The second year of my life, although I had been *shoved* out of the cradle by another "responsibility," was attended by as great a danger almost, if not quite, as that which is said to have befallen another *great* baby, Hercules. He, you know, is said to have been assailed by a serpent—I, it will be understood, by a rat. It was in this wise: Although with "blushing honors thick upon him," still my "illustrious predecessor" had the misfortune to live in a *mean* cottage, where the parlor and kitchen were both one room, and the bed-room the second and only other room in the house, which was infested with rats—only surpassed in that respect by those in some of the political offices now-a-days. My parents had placed me at the foot of the bed to sleep, where, about the time of midnight, I was attacked by a hungry "quadruped," who, having forced his tooth into my proboscis and penetrated the vein, made the affair a bloody one, and left a scar from the wound, as a melancholy memento of the fact, until this day. But, thanks to a kind Providence, I still survive. The only other circumstance of those days, which was *impressed* upon my—nose, was, that in clambering up to the *sky* parlor I had the misfortune to fall some ten feet to the floor below, causing another *bloody* time. If I do not possess the warlike ambition of my ancestors in my nature, it is not because I did not bleed enough for my country in my youth.

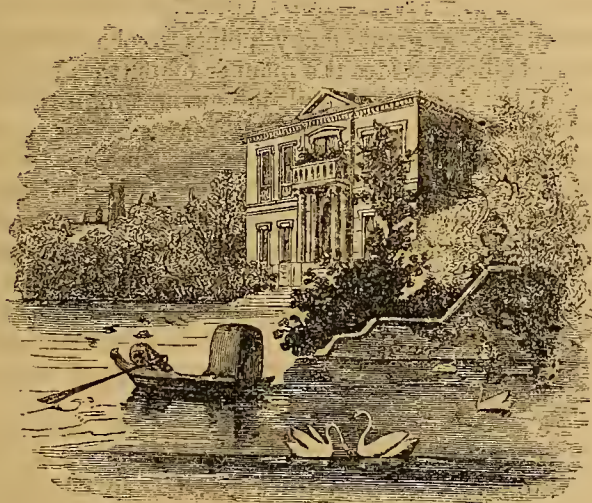

MRS. SNUG'S PATERNAL HOME.

My mother—blessed be her memory—took much pains during my infancy, to impress upon my youthful mind the *traditional* fact, that my ancestry were among the first emigrants to this country, and that her great-great-grandfather was no less distinguished a personage than the redoubtable Captain Miles Standish, who came a passenger from Plymouth in the *May Flower*, in 1620, with other Pilgrims, landing upon the dreary and inhospitable shores of Massachusetts in the depths of a severe and cheerless winter. Many a long winter's evening, seated beside a huge log fire, supplied with a mug of hot ginger-cider of my father's own making, and a basket of pipkins, rivaling the golden apples of fabled antiquity, has my fond mother entertained her honored offspring with recitals of the chivalric adventure in which her ancestry were engaged—instilling thus early into her children's hearts that deep and fixed love of country which distinguishes the character of all New Englanders.

My father, who was of a thoughtful rather than of a communicative turn of mind, never said much on the subject, but in some way, in a general conversation of the

family, it leaked out that my paternal ancestry formerly went by the name of *Snig*, and it was left with me in part to surmise that my great-grandfather's name was Cornelius Snig, which, not being exactly euphonious enough to suit his peculiar taste, he—just as a great many other individuals have since done—corrupted, and changed into Snug.

It would seem that my great-grandfather was as much celebrated for his laughing propensities as my father was for his taciturnity, particularly when his friends entertained him with some good story. This propensity in the old gentleman induced the younger branch of the public to call him "Old Sniggle." This, the old man thought, was carrying matters a little too far, but one day he accidentally heard an imprudent neighbor mention something about "uncle Sniggle," and as he considered the remark applied to him, he determined from that moment to write *his* name *Snug*, by changing one vowel for another. Time eventually completed his work.

Soon after this, my grandfather, now known as Absalom Snug, having removed from the State of Massachusetts into Connecticut, and having distinguished himself as a militia captain in the Revolutionary War, in view of his valuable services in "licking the red-coats," his grateful townsmen were led to honor him by calling their newly-appointed village Snugtown, in compliment to his name and distinguished services. In this village I was born, and so was my father, likewise, whose name, in compliment to his father's worthy and admired general, was named Washington.

My parents, Washington Snug, *nee* Snig, and Patience, his wife, were very well matched in one respect: the time he was accustomed to spend in silence, she improved by talking; whereas, had the contrary been the case, there *might* have always been disputes and janglings. In process of time, this worthy couple were blessed (so thought Mrs. Snug) with two sons and two daughters; Cornelius, named after his aged grandfather, was the oldest; Caleb, Fanny, and Patience (after her mother), were their successive names. As Cornelius grew up, he found employment with his father in the management of the farm. Whether nature's suggestions were followed out or not, is a question difficult to determine, even at this period of life, for at an early age of my life my predilections ran in favor of learning "the art preservative of all arts," or, in other words, of learning the printing business; but my anxious mother having one day observed a fine carriage pass through the principal street in Snugtown—which was a rare sight in that day—*her* choice was made in favor of that trade for her son. Besides, it was a very frequent observation among the Snugtown folks, that the Messrs. FLATT & TOWNER, carriage-makers, in the neighboring village of Sawgetup, were prosperous, and making money very fast.

Somehow my mother had imbibed such an exalted idea of the respectability attached to the business of carriage-making generally, that from the tenth until I became sixteen years of age, she left no opportunity unimproved in impressing upon my youthful mind her strong convictions that the business was not only *very* respectable, but also *VERY* profitable. To her numerous acquaintances who visited our house, she would say, when asked the question in my presence: "Caleb is going to be a carriage-maker when he gets to be old enough;" so, by the time that I had arrived at the age of sixteen, her predilections had overcome my *natural* propensities, and to the business, *from*

choice, I seemingly went. On Mr. Flatt's visit to Snugtown, he called, by invitation, on our family, to arrange the terms on which I was to go as his apprentice for five years. After the preliminaries had been settled, by which Mr. Flatt was to try the boy for four weeks, and the boy was to see how he liked his boss in the meanwhile, the Sawget-up carriage-maker was about to leave, when my interested mother "wished Mr. Flatt would be seated only one mo-

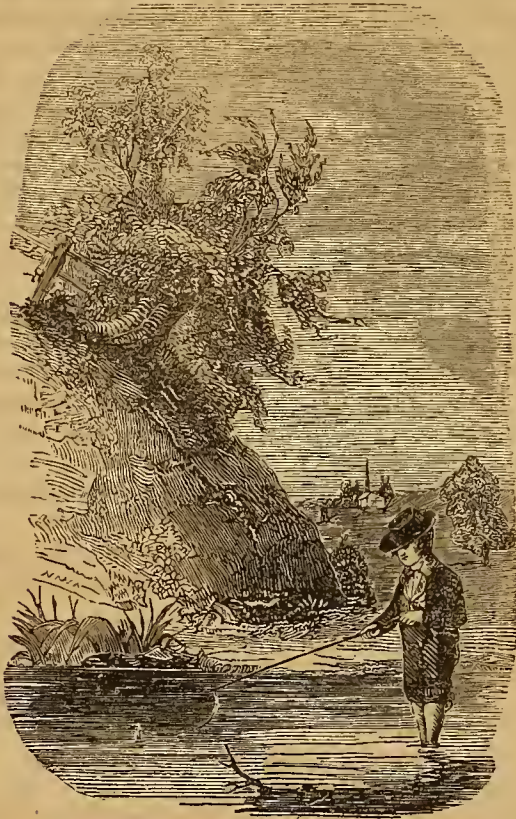

DISTANT VIEW OF SNUGTOWN.

ment." Mrs. Snug not only thought a good pedigree necessary to a good start in life, but that it was absolutely necessary that one's boss, with whom he was about to learn a trade, should be made acquainted with the fact that I was a *smart boy*. This, then, was the moment to be improved, and she did improve it. She was determined that the first impressions in Mr. Flatt's mind, of her son's "good points," should be favorable, if by any possibility she could accomplish an object she thought so desirable. Accordingly, after telling him what a smart and good boy Caleb had always been, even from childhood, and how well he could spell every word to be found in Webster's Spelling-Book, she brought out a large bound, board-covered folio, in MS., with every rule in the far-famed "Daboll's Assistant" worked out and copied therein. This prodigious labor, the fruit of *four or five winters*, at a school in the village, was considered, in those days of slow progress, to be a great accomplishment, and presumptive evidence that the boy would "make his mark," in time.

From these manifest evidences before him, Mr. Flatt had sufficient reasons for thinking that his intended apprentice would prove himself a good mechanic, in course of time, should his early-shown industrious habits be continued during his five years' apprenticeship. This would place him on a footing with any one in the craft; but when, with a smile of triumph, my mother, in addition thereto, brought out another and similar MS. volume of Flint's Surveying, containing all the rules of trigonometry, geometry, &c.,

all written out, and the difficult plots of right-angled triangles, obtuse angles, trapezoids, polygons, parallelograms, and other odd-shaped fields, all correctly drawn therein, and a protracted, as her son's handiwork, the evidences of his genius *must* be conceded—so thought *my* mother, Mrs. Snug. I have very little doubt but that dreams of profit from my industry and intelligence already flitted across Mr. Flatt's brain, as he wended his way home; for the old lady had evidently accomplished her purpose, by making a strong impression in her son's favor. Before leaving, however, after directing me to come on and begin business early on Monday morning, Mr. Flatt, in a rather serio-comical manner, gave me to understand that I would find with them—Messrs. Flatt & Towner—"a plenty of hard work, and hard fare." I at the time considered the remark as made by way of joke. In the sequel the reader will find that this assertion, seemingly made in a joke, was literally verified in fact, just as had often happened before, and has since.

(To be continued.)

For the New York Coach-maker's Magazine.

## GEOMETRY OF CARRIAGE ARCHITECTURE.

BY A PRACTICAL COACH-MAKER.

### PART FIFTH—BODY CONSTRUCTION.

THERE are a great many points to be observed in building bodies, besides the manner of putting them together. What does a well-built job amount to, if the timber is not thoroughly seasoned? It may keep its place by coaxing along with an application of glue to the joints while it is in the wood-shop, but when it leaves that, and is exposed to the heat of the paint-shop, and afterward to that of the varnish-room—which is mostly kept extremely hot—then comes the perplexing time for the boss and jour., when the joints are opening, panels splitting, etc., etc. Now, to avoid all these difficulties, it is necessary to look ahead, and have all the timber properly stored beforehand, and in process of seasoning.

There should be no timber used in a body, or anywhere about a carriage, that has not had at least one year in seasoning to every inch in thickness. Then it should be kept in a place where it will have a free current of air all the time; each plank separated half an inch apart, with slips placed directly over each other, else the plank will be liable to spring. Panel-stuff should be treated in the same manner; and when a body-maker commences a job, his first care should be to look after his panel, roof, bottom-stuff, and the linings, get them all planed up to their proper thickness, and put them up in some safe place where they will get a moderate degree of heat, each panel separated with slips; and all other stuff that will be required for the job should be selected out, and put away till required for use, such as side-lights, shutter-stuff, etc. If all these things were strictly attended to, there would be less trouble about bad joints; and it would be to the employer's interest to look after such workmen as do not know enough to see these things themselves, and have those rules strictly enforced, and I am sure it would be much more satisfactory to the jour., for he might as well get them out at the commencement as to wait until he is ready to use them, when he knows that such a course must be taken finally.

We now propose taking the different styles of work

given in the first volume of this publication, and subject them to a regular *anatomical* examination, giving illustrations of the frame-work and the best methods of construction, as far as it is practicable to do so, along with many other hints and suggestions worthy of note. This must not be taken by those well versed in their business as dictatorial; on the contrary, we solicit criticism, when done with a view to benefit the craft and bring to light hidden genius, which every man ought to be philanthropic enough to give to those who have not had the same advantages as themselves, but who are yet fully entitled to all the information that can be given them. How many worthy young men are launched on the world, after their apprenticeship, with only a superficial knowledge of their business! It is true, there are some who are not entitled to much sympathy—such as change from one thing to another, until they are on the eve of being their own masters, when they run into a carriage-shop for one or two years, to learn their trade, and when they are twenty-one they just know enough to feel their ignorance. If there was a law made and put in force, regulating apprenticeships, by indenture, poor workmen would not be so numerous as now, and the journeymen would themselves feel more interested in a boy's welfare.

(To be continued.)

## COACH-MAKING HISTORICALLY CONSIDERED AND INCIDENTALLY ILLUSTRATED.

BY THE EDITOR.

Continued from page 3.

### CHAPTER XIV.

Coaches and other vehicles so numerous as to become a nuisance—The introduction of stage-coaches into Scotland—Tyne Moryson's picture of travel in England at the close of the 16th century—The "coach-and-six" of the Duke of Buckingham—Law against the use of hackney-coaches in London, etc.—The *Sedan* fever—Beer-cart *versus* Coach and Sedan—The Beer-cart judgment.

VEHICLES of all kinds having now become general, a great complaint was raised against them. William Lilly, in one of his published plays, complains of those who were accustomed to go to a battle-field "on hard-trotting horses, now riding up and down to court ladies." In the narrow streets of old London, where these new "institutions" had become so numerous, and among a people so unused to them but a short time previously, these vehicles were a great hindrance to business. Should any of our readers need a realization to understand the matter, they have simply to undertake to force their way through Broadway below the City Hall Park almost any day in the week. The Water Poet, before referred to, says of the London streets: "Butchers cannot pass with their cattle for them; market people who bring their provisions to the city are stopped, stayed, and hindered; carts or wains, with their necessary wares, are debarred and letted; the milkmaid's ware is often spilt in the dirt." Although so generally in use, yet, being without springs, in the language of Taylor, the people were "tost, tumbled, rumbled, and jumbled without merey."

About the year 1610 a person in Scotland—a native of Stalsund, in Pomerania—offered to contract for a certain number of coaches and wagons, with horses to draw and servants to attend them. Accordingly, a royal patent was granted him, conferring an exclusive privilege, for fifteen years, of running between Edinburgh and Leith. This is

probably the earliest instance of a vehicle claiming the name of stage-coach. In "Tyne Moryson's Itinerary; or, Ten Years' Travel throughout Great Britain and other parts of Europe," published in 1617, describing the state of traveling in the latter end of the fifteenth century, we have the following curious picture, which may be of interest in this connection. He says:

"In England, toward the south and in the west parts, and from London to Berwick, upon the confines of Scotland, post-horses are established at every ten miles, or thereabout, on which travelers ride a false gallop at the rate of ten miles an hour sometimes, but that makes their hire the greater. With a commission from the chief postmaster, or chief lords of the council (given either on public business or the pretence of it), a passenger pays two-pence-half-penny a mile for his horse, and the same for his guide's horse; but if several persons travel in company, one guide will do for the whole. Other persons, who have no such commission, must pay three-pence a mile.

"This extraordinary charge for horse-hire is well recompensed by the greater speed of the journey, by which the increased expense of inns, in slow traveling, is avoided. All the difficulty is in bearing the great fatigue. The traveler is at no expense for the food of these horses; but, at the end of the ten miles, the boy who takes them back expects a few pence in the way of a gift. For the most part, Englishmen, especially in long journeys, ride their own horses. But if any person wishes to hire a horse at London, he pays two shillings the first day, and twelve, or, perhaps, eighteen-pence a-day afterward, till the horse is brought back to the owner. In other parts of England, a man may hire a horse for twelve-pence a-day, finding him meat; and if the journey be long, he may hire him at a convenient rate for a month or two. Likewise, carriers let horses from city to city, bargaining that the passengers must put up at their inns, that they may look to the feeding of their horses. They will thus lend a horse for a five or six days' journey, and find the animal meat themselves, for about twenty shillings. Lastly, these carriers have long, covered wagons, in which they carry passengers from city to city; but this kind of journeying is very tedious, for they must take wagon very early, and come very late to their inns; so that none but women and people of inferior condition travel in this sort. Coaches are not to be hired anywhere, but at London; and although England is, for the most part, plain, or consisting of little pleasant hills, yet the ways far from London are so dirty that hired coachmen do not ordinarily take any long journeys. For a day's journey, a coach, with two horses, is let for about ten shillings a-day, or some fifteen shillings a-day for three horses, the coachman finding the horses' meat; if the journey be short, about eight shillings will suffice, but then the passengers pay for the meat of the horse. One horse's meat will cost twelve-pence, or eighteen-pence for one night, for hay, oats, and straw; but in summer, they are put to grass at three-pence each, although those who ride long journeys keep them in the stable on hard meat, as in winter, or else give them a feed of oats when they come from grass in the morning."

About the year 1620, the Royal Favorite, the Duke of Buckingham, carried his pomp so far as to put six horses before his coach, from which circumstance arose the phrase, "a coach-and-six."

In 1625, in the 22d year of King James, hackney-coaches were set up in London, and stood ready at the

inns, to be hired as wanted; and apparently they must have speedily come into fashion, for in the reign of Charles the First, ten years afterward, there was a law passed forbidding "the general and promiscuous use of hackney-coaches in London and Westminster, or their suburbs, being not only a great disturbance to his Majesty, his dearest consort the queen, the nobility, and others of place and degree, in their passage through the streets, but the streets themselves were so pestered, and pavement broke up, that the common passage is hereby hindered, and the prices of hay and corn exceedingly dear. Therefore, it is commanded and forbidden that no hired coaches should be used in London, &c., except they be to travel three miles out of the same; and also, that no person shall go in a coach in the said streets, except the owners of the coach shall constantly keep up favorable horses for our service when required."

This proclamation alluded to public coaches, that had then recently been established by certain private individuals, who contracted to carry passengers from one town to another, in large, cumbersome vehicles, without springs, and were so designated. But these miscalled expeditions were always performed with much caution and great solemnity; the horses being seldom, if ever, allowed to indulge in a trot.

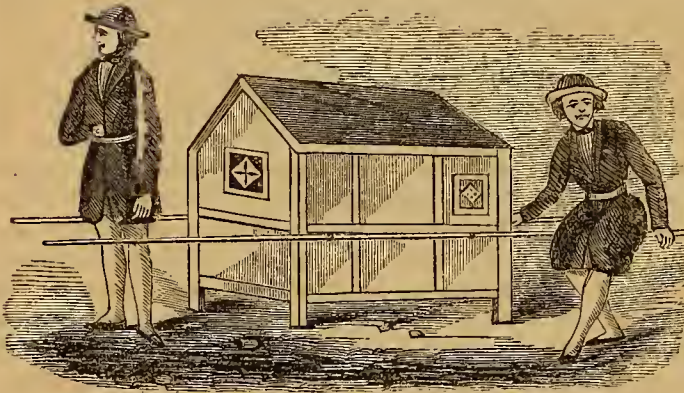

THE SEDAN OF 1635.

Ten years afterward, when coaches and other vehicles had become numerous, the *sedan* fever broke out in England, with such violence as seemed for a time to threaten the very existence of the "great hypocrites," as in our last chapter we find the coaches called by Taylor. In 1635, a patent was granted to Sir Saunders Duncombe for the introduction of sedans; his purpose being, "to interfere with the too-frequent use of coaches, to the hindrance of the carts and carriages employed in the necessary provision of the city and suburbs" of London.

From the introduction of the Knights' sedan, a rivalry arose, which gave rise to a humorous tract, entitled "Coach and Sedan: a pleasant dispute for precedence, the Brewer's Cart being Moderator." This was published the next year after the sedan appeared, in 1636. The *parties* to the dispute are thus described: "The one (Sedan) was in a suite of green, after a strange manner, windowed behind and before with isinglasse (talc), having two handsome fellows in green coats attending him; the one ever went before, the other came behind. Their coats were laced downe the back with a green lace suitable; so were their half sleeves—which persuaded me at first they were some cast [cast-off] suites of their masters. Their backs were harnessed with leather angles cut out of a hide as broad as Dutch collops of bacon." "The other (Coach) was a thick,

burly, square-set fellow, in a doublet of black leather, brasse-buttoned downe to the breast, back, sleeves, and wings, with monstrous wide bootes, fringed at the top with a net fringe, and a round breech gilded, and on the top an achievement of sundry coats in their proper colors, &c., &c. Hee had only one man before him, wrapt in a red cloake, with wide sleeves, turned up at the hands, and cudjelled thick on the back and shoulders with broad shining lace (not much unlike that which mummers make of strawen hats); and of each side of him went a lacquey, the one a French boy, the other Irish, both suitable alike." The author makes Sedan say, by way of argument, "Now, Coach, twice or thrice a year you must needs take a voyage to London with your ladie, under a cullor [jacket], to be new cullored, gilded, or painted, covered, seated, shod, or the like; when her errand indeed is, as one saith well, speaking to such ladies who love to visit the city,

"To see what fashion is in most request—  
How is this countess and that court ladie drest."

"Hence it happens, Coach, that by your often ambling to London, Sir Thomas or Sir John sinks, as in a quick-sand, by degrees, so deep into the merchant, mercer, or lawyer's booke, that hee is up to the ears, ere hee be aware; neither can he well be drawne out without a teame of usurers, and a craftie scrivener to be the fore-horse, or the present sale of some land; so that wise men suppose this to be one maine and principal reason why within a coach journey of a day or two from the citie, so many faire inheritances as have been purchased by lord mayors, aldermen, merchants, and other rich citizens, have not continued in a name to a third—yea, scarce the second generation; when, go far north or westward, you shall find many families and names of nobilitie and gentry to have continued their estates two and three hundred years, and these in a direct succession." Adams remarks, that Mr. "Beere-cart" seems an apt disciple of the lawyer who made the celebrated oyster decision, for he thus finishes the dispute: "Coach and Sedan, you both shall reverence and ever give way to Beere-cart wherever you shall meet him, either in citie or cuntry, as your auncient and elder brother."

Leaving Coach and Sedan, both, to mourn over their humiliating sentence, we must consign them for the present to their hard fate. In our next chapter we shall find that, as with most cases now-a-days, this verdict was appealed from to another court, in hopes of obtaining a more favorable judgment.

From Blackwood's Magazine.

#### THE MAGIC LAY OF THE ONE-HORSE CHAY.

MR. BUBB was a Whig orator, also a soap laborator,  
For everything's new-christen'd in the present day;  
He was follow'd and adored by the Common Council board,  
And lived quite genteel with a one-horse chay.

Mrs. Bubb was gay and free, fair, fat, and forty-three,  
And blooming as a peony in buxom May;  
The toast she long had been of Farringdon-Within,  
And fill'd the better half of the one-horse chay.

Mrs. Bubb said to her Lord, "You can well, Bubb, afford,  
Whate'er a Common Council-man in prudence may;  
We've no brats to plague our lives, and the soap-concern thrives,  
So let's have a trip to Brighton in the one-horse chay.

"We'll view the pier and shipping, and enjoy many a dipping,  
And walk for our stomach in our best array;  
I longs more nor I can utter, for sbrimps and bread and butter,  
And an airing on the Steyne in the one-horse chay.



"We've a right to spare for nought that for money can be bought,  
So to get matters ready, Bubb, do you trudge away;  
To my dear Lord Mayor I'll walk, just to get a bit of talk,  
And an imitation-shawl for the one-horse chay."

Mr. Bubb said to his wife, "Now I think upon't, my life,  
'Tis three weeks at least to next boiling-day;  
The dog-days are set in, and London's growing thin,  
So I'll order out old Nobbs and the one-horse chay."

Now Nobbs, it must be told, was rather fat and old,  
His color it was white, and it had been gray;  
He was round as a pot, and when soundly whipt would trot  
Full five miles an hour in the one-horse chay.

When at Brighton they were housed, and had stuffed and caroused,  
O'er a bowl of rack punch, Mr. Bubb did say,  
"I've ascertain'd, my dear, the mode of dipping here  
From the ostler, who is cleaning up my one-horse chay."

"You're shut up in a box, ill-convenient as the stocks,  
And eightpence a-time are obliged for to pay;  
Court-corruption here, say I, makes everything so high,  
And I wish I had come without my one-horse chay."

"As I hope," says she, "to thrive, 'tis flaying folks alive,  
The King and them extortioners are leagued, I say;  
'Tis encouraging of such for to go to pay so much,  
So we'll set them at defiance with our one-horse chay."

"Old Nobbs, I am sartin, may be trusted gig or cart in,  
He takes every matter in an easy way;  
He'll stand like a post, while we dabble on the coast,  
And return back to dress in our one-horse chay."

So out they drove, all drest so gaily in their best,  
And finding, in their rambles, a snug little bay,  
They uncased at their leisure, paddled out to take their pleasure,  
And left everything behind in the one-horse chay.

But while, so snugly sure that all things were secure,  
They founced about like porpoises or whales at play,  
Some young unlucky imps, who prowld about for shrimps,  
Stole up to reconnoitre the one-horse chay.

Old Nobbs, in quiet mood, was sleeping as he stood  
(He might possibly be dreaming of his corn or hay);  
Not a foot did he wag, so they whipt out every rag,  
And gutted the contents of the one-horse chay.

When our pair were soused enough, and returned in their buff,  
Oh, there was the vengeance and old Nick to pay!  
Madam shriek'd in consternation, Mr. Bubb he swore —!  
To find the empty state of the one-horse chay.

"If I live," said she, "I swear, I'll consult my dear Lord Mayor,  
And a fine on this vagabond town he shall lay;  
But the gallows-thieves, so tricky, hasn't left me e'en a dicky,  
And I shall catch my death in the one-horse chay."

"Come, bundle in with me, we must squeeze for once," says he,  
"And manage this here business the best we may;  
We've no other step to choose, nor a moment must we lose,  
Or the tide will float us off in our one-horse chay."

So noses, sides, and knees, altogether they did squeeze,  
And, pack'd in little compass, they trotted it away,  
As dismal as two dummies, head and hands stuck out like mummies  
From beneath the little apron of the one-horse chay.

The Steyne was in a throng, as they jogg'd it along,  
Madam hadn't been so put to it for many a day;  
Her pleasure it was damped, and her person somewhat cramped,  
Doubled up beneath the apron of the one-horse chay.

"Oh would that I were laid," Mr. Bubb in sorrow said,  
"In a broad-wheeled wagon, well covered with hay!  
I'm sick of sporting smart, and would take a tilted cart  
In exchange for this bauble of a one-horse chay."

"I'd give half my riches for my worst pair of breeches,  
Or the apron that I wore last boiling-day;  
They would wrap my arms and shoulders from these impudent  
beholders,  
And allow me to whip on in my one-horse chay."

Mr. Bubb ge-hupped in vain, and strove to jerk the rein,  
Nobbs felt he had his option to work or play,  
So he wouldn't mend his pace, though they'd fain have run a race,  
To escape the merry gazers at the one-horse chay.

Now, good people, laugh your fill, and fancy, if you will,  
(For I'm fairly out of breath, and have said my say),  
The trouble and the rout, to wrap and get them out,  
When they drove to their lodgings in their one-horse chay.

The day was swelt'ring warm, so they took no cold or harm,  
And o'er a smoking lunch soon forgot their dismay;  
But, fearing Brighton mobs, started off at night with Nobbs,  
To a suagger watering place, in the one-horse chay.

## The Home Circle.

For the New York Coach-maker's Magazine.

### LOVE AND MONEY.

(Continued from page 9.)

#### CHAPTER III.

"For of all sad words of tongue or pen  
The saddest are these: It might have been."—WHITTIER.

THE next morning, like many a belle, rose calm and beautiful, as though it had never wept itself to sleep the night before. The usual hour found Gustavus A. F. at Temperly's office, determining within himself to say nothing of the proceedings of the evening previous; but fate and his friend would not have it so.

"Well Gussy," said Tom, when he had leisure, "how did you find all at our friend Howard's last evening?"

"At Howard's! ah, I didn't go; I changed my mind."

"Didn't go?" said Temperly in surprise, "why Farrenton said he met you dashing along the Newport-pike in gallant style."

"True," said Gussy, coloring, "I took a ride out that way, but it looked like rain, you know, so I concluded to postpone my visit; but," continued he, anxious to change the subject, "are you going to Mad. F.'s to-night? It will be a brilliant affair, I am told; altogether exclusive flowers for the supper alone to cost over a hundred dollars."

"No," said Temperly, gravely, "I dislike balls!—cannot even get up the necessary admiration for them, when I think how many poor that squandered money might relieve."

"Now, Parson Brown, preach a little, do, it's so appropriate to a good-looking youngster like yourself, Tom; if you were not such a dry chip, and would spruce up a little, and lay aside some of your hum-drum notions, you might make the best match in Cincinnati."

"I'll let you do that, Gussy," said Tom good-humoredly, "meantime, you've heard, I suppose, that Miss Howard is to be at Mad. F.'s to-night."

"No," said G. half-inquiringly, half-evasively; for he *had* heard. "Who told you?"

"Farrenton; it seems he is interested in 'The Heiress,' as he also calls her, although he has not met her as yet. Poor girl, I pity her; she will never stand a chance of being loved for herself alone, I fear."

"Save your pity for those who need it, Tom. I mean to do the handsome by her, I can tell you—bless her little soul! Why, I wouldn't hurt her feelings for the world; but what are you going to do with yourself to-night, Tom?"

"I am going to a little sociable at Mrs. M.'s."

"Well, upon my word, Tom, you'll turn out a Methodist parson yet, as sure as you're born. I can't endure that woman; she has always some charity-tale manufactured to hand, for some poor forlorn object or other, and I don't like appeals to my pocket, I can tell you; it's as much as I can do to rake and scrape up sufficient for my own wants, limited as they are."

And Gustavus Adolphus Flash lifted his jeweled hand, flourished his perfumed, embroidered handkerchief, and blew his nose with the air of a man who really believed himself.

"Gussy," said Tom, earnestly, a shade of feeling, rather than displeasure, crossing his brow, "say nothing unkind of Mrs. M., for my sake, if not for her own; that you can do so proves how little you know her in reality. A nobler woman, or better Christian, does not exist; but here is Bowen's brief, suppose *you* attend to that. I've enough without that at present."

"Oh, don't bother me with business just now, Tom; I'm much indebted certainly, but wait till after to-night, then I'll think of it."

Thomas Temperly looked after his friend, as he left the office, and a feeling of pity softened his fine features to almost womanly tenderness, as he thought of the bright-eyed innocent companion at the old school-house of A—, and remembered what he was then, and, with different training, what he might have been now.

#### CHAPTER IV.

"Holy hath been our converse, gentle friend!"—MRS. HEMANS.

THE full May moon was shining beautifully, as carriage after carriage rolled smoothly up to Mad. F.'s stately mansion, in front of which carpets were spread, so that the dainty white-slippered feet might pass unsoiled to the broad marble steps. Within were the tasteful evidences of wealth: soft, rich colorings, blended and harmonized by shaded artificial lights, music, and dancing, and over all a flood of gas, subdued to softness, shining down on "fair women and brave men;" among which latter, the happiest of the happy, handsomer in his splendid new suit, than even he thought he could be, figured our friend Gustavus. This suit, I'm sorry to say, was unpaid for; but Gussy did not mean to be dishonest, he was only "*looking a little ahead*," as he facetiously observed to himself, in apologizing to his own conscience. Gussy prided himself on his attractive manners, and with some show of reason, where he thought *it would pay*, as many a bright smile of welcome proved, as he moved hither and thither among the gay and fashionable throng, chatting gaily with one, waltzing with another, and rendering himself agreeable generally; though ever watching the entrance-door expectantly, and never, by any means, forgetting to scrutinize carefully each newcomer.

We will leave Gustavus Adolphus Flash surpassing himself, and take our quiet moon-lit way to Mrs. M.'s sociable. What a contrast! it was a quiet, social, home-like gathering, just large enough for all to be interested in, and friendly with, each other. Temperly seemed to be enjoying himself thoroughly. He had been introduced to several strange young ladies, and being somewhat modest, and slightly embarrassed, he had failed to gather their names distinctly; but the fair, refined-looking girl, with

pleasant brown eyes, next whom he happened to be seated, really charmed him. She had not beauty of face or feature beyond what is ordinary, to boast of; but she was lively, sensible, had an agreeable voice, and her clear hazel eyes shone with an expression so singularly sweet, that it must have emanated from a heart at peace with itself and all mankind. Somehow or other, it seemed familiar to Temperly; but it could not have been either, he thought, for, save his mother, a few at his boarding-house, and two or three others, he had no lady acquaintances whatever. He could have remained beside her delightedly all the evening, but he dared not monopolize, so he contented himself, while politely attending to others, with observing her. She did not appear to be self-poisoned, never glanced round to see what effect her really good conversational powers had on others; seemed to be quite as much pleased in the company of ladies as gentlemen; though the latter sedulously sought her society; and above all, was respectful, deferential, even, to the few old people present. Then there was a certain modesty of deportment, a certain self-abnegation of manner, that marks the person who forgets self, in the desire to render others happy. Altogether, she was decidedly the most interesting study Temperly had ever encountered. Was he deceived, or did he flatter himself? No, certainly; her eyes occasionally sought him, and they never met his for a moment to be modestly withdrawn, without sending a shrill of pleasure through his whole frame. He managed to spend the last part of the evening at her side, and meant to obtain from Mrs. M. her name and place of residence; but that lady was so surrounded when he went to take leave, that he found it impossible. Long after he retired that night, he lay awake, recalling all that she had said; her looks, her tones, her manner even, and when, towards morning, he fell asleep, the animated face, with its sweet expression, floated through his dreams.

The next day but one, which was Sunday, found Temperly at Church, with his mother, at A—, as usual, but what was his surprise and pleasure, when the Sunday-school scholars entered, to see, at the head of a class, the pleasant acquaintance of Mrs. M.'s sociable. Who could she be? Where was she staying? He would give anything to know. Temperly was always remarkably devout and attentive at Church, but this morning his thoughts and eyes would wander occasionally during service, in spite of himself. It was his mother's custom to go directly out of Church and home, so he did not get to see with whom she came, or what direction she took; but she recognized him pleasantly as he passed by the pew where she stood with her scholars. There was a richly-dressed, aristocratic-looking young lady in the Howard pew that morning, whom Temperly surveyed with some curiosity, mistaking her for "The Heiress." She was a Miss Howard truly, but not *the* Miss Howard; only a cousin of the Doctor's, who was spending the summer with them. Ridge Cottage, a mile from A—, stood in the centre of the farm, about midway of the rich, extensive, and beautiful ridge from which it took its name. It was a most pleasant-looking building, with its wide, cheerful-looking hall in the centre; parlor, on one side, and library on the other; had full-length windows, and pillared piazzas, bright with roses and blossoming vines; was finely shaded by the splendid maples that dotted the lawn. The farm, consisting of several hundred acres, extended almost to the town, being separated only by a strip of fine old forest trees, called

Ridgewood. The solitude of Ridgewood was enlivened by a babbling brook, and the concerts of myriads of little tuneful minstrels, especially at this season of the year. It had always been a favorite resort of Temperly in boyhood, and now, as his mother, complaining of headache, had gone to lie down, he took his little pocket Bible, and wended his way thither. He had not gone far into the heart of the fine old wood, before he saw a lady seated on the trunk of a fallen tree in a sequestered spot, reading; and what was his surprise and pleasure on discovering it to be the identical brown-eyed lady for whom he was vainly endeavoring to discover "a local habitation and a name." She looked very sweetly there, he thought, in her attitude of careless grace, her white dress in striking contrast to the brown trunk and bright greensward. The tree above her was draped with a vine whose dark leaves hung over the fair head, with its wealth of light-brown hair, in festoons of emerald. As soon as the lady saw him, she spoke to him, frankly and kindly, and he ventured to approach.

"It seems to be our fate to meet by accident, Mr. Temperly; this is the second time we have met under peculiar circumstances."

"I do not remember to have had the pleasure before, unless you mean at church this morning."

"No, that is the common course of events. I'm alluding to the time when you favored me with an umbrella in the city."

"It was you, then? I thought I had seen you somewhere, before at Mrs. M.'s sociable, but I could not tell where."

"Yes; I had been lost and so belated, and your little kindness came very opportunely to the relief of my new spring bonnet, to say nothing of the wearer. Isn't this a beautiful spot?—those grand old trees—that picturesque group of rocks—the clear stream—and these soft, beautiful mosses underneath our feet."

"Beautiful, indeed," said Temperly, seating himself, also. "May I ask what book you are reading?"

"It is a little book called 'Precious Lessons,' and here are a couple of verses which one cannot meet too often. Read them aloud, please." And Temperly read—

"O, gently scan your brother man,  
Still gentler, sister woman;  
Though they may go a trifle wrong,  
To step aside is human.  
One point must still be greatly dark,  
The moving reason—why they do it;  
And just as lamely can ye mark  
How far, perhaps, they rue it."

"How good!" said Temperly; "it would be well to bind that principle about one's heart, and make it a rule of action."

"Yes; if one could only be as lenient to others' failings as one's own, what a happy world this would be! The author of that little volume quotes beautifully, I think: here, at the close of the first lesson, is a quotation on Time; see what you think of it."

Temperly read and admired; he then glanced on through the book, reading aloud where anything struck his fancy, and listening with pleased attention to the remarks elicited, until he came to this paragraph: "The Scotch poet, Allan Ramsay, in his celebrated pastoral drama, 'The Gentle Shepherd,' finds a beautiful illustration of marriage in two aged elms, growing side by side. He supposes them to have been, 'some years

since,' as bridegroom and bride. Each year they have pressed nearer and nearer to each other, until their spreading branches have mingled, and, as he sings in old Scottish phrase,

" 'This shields the other fra' the eastern blast,  
That in return defends it fra' the west.'"

"Had they stood apart and alone, each must have borne the violence of every wind, and bowed unsheltered before every storm."

"How beautiful!" he exclaimed, thoughtfully. "Washington Irving's well-known simile of the Oak and the Vine does not surpass it." And he was silent awhile, for his heart warmed to that beautiful image, and he could not help picturing companionship like that with the gentle being beside him.

"I beg your pardon," said he, recollecting himself, "but I believe I did not hear your name distinctly, when introduced the other evening."

"One scarcely ever does at introductions; but you a lawyer, I'm surprised that you should let a name slip," said the lady mischievously.

"That of a lady, too," replied Temperly, in the same strain; "but if you will intrust me with it now, I will promise amendment in future."

"Better begin now by repressing curiosity; but it is drawing toward sunset," and the lady started to go.

"I may at least see you safe home," said Temperly, rising to accompany her.

"No, thank you, not now; good-bye, Mr. Temperly;" and before he could get over his surprise she was gone.

Though half-provoked at her abrupt desertion, he went to church that evening, determining to follow her in the distance to her home, but she was not there. The next morning, the first thing he did on reaching the city was to call on Mrs. M. to find out something about his fair incognita, but he was too late; she had already gone to her country residence at Clifton.

Professional business called Temperly to A—— during the week, where the county court was held, and while there, he met Dr. Howard, who, in common with all who knew Temperly, thoroughly respected him. The Dr. insisted on T.'s going home with him to tea, but Temperly declined at first, having no desire to be numbered among the Dr.'s visitors at present; but he had finished the duties of the day satisfactorily, and having no engagement for the evening to plead in excuse, he was overruled, and accompanied his friend. On entering the parlor at Ridge Cottage, he was amply rewarded by seeing his fair incognita turning the music at the piano for the richly-dressed lady of Howard's pew. She instantly advanced to receive him, her eyes brightening with pleasure.

"Ah! you have met Emily before, I see. Augusta, Mr. Temperly, of Cincinnati, Miss Augusta Howard, Temperly; and now, if you will excuse me awhile, I will leave you in charge of the ladies, for I find by my slate here, that I shall have to leave immediately—a neighbor having fallen and dislocated a limb. I regret this exceedingly, for his sake as well as my own, but I will return as soon as possible. Meantime make yourself perfectly at home;" and the Dr. was gone. Miss Augusta was quiet, reserved even, and, on some pretext or other, soon left the room not to return. It must be confessed, however, that Temperly, though perfectly polite and respectful, was not so sedulously anxious to please the supposed heiress as Emily, whom he was delighted to see again. Besides,

thought he, did she not receive homage enough from others. He would convince her, for his part, that there was one man in the world, at least, who was above seeking her society simply because she was the favorite of Fortune. Dismissing the lady from his mind, he yielded himself up to present enjoyment—not too much so, however, to forget to ask for the name which had been withheld before. "It is Howard, Emily Howard; I am Augusta's cousin." How modestly she takes a secondary position, thought Temperly, but in this, however, he was mistaken. The observant Emily had gathered Temperly's erroneous impression almost by intuition, and, for reasons of her own, determined not to set him right. The evening passed delightfully to Temperly, and he did not leave without asking and obtaining permission to call again. As he rode home that evening, he began to calculate the chances of keeping a wife, in good earnest. He could keep her comfortably now in their simple cottage home with his kind and gentle mother, but in a year, if Emily preferred, he could, with his present prospect of rapidly increasing practice, maintain a modest home in the city; and they could spend their summer months with his mother. At any rate, if Emily would only consent, he would work night and day to maintain and render both wife and mother happy, and he did not despair of succeeding in his dearest wishes. After this evening's conversation, he thought he perceived, without flattering himself, that she was not indifferent to him; for as Byron says, "quickly comes such knowledge" to a lady, and it is to be presumed that gentlemen are not far behind them in discrimination.

(To be continued.)

## Pen Illustrations of the Drafts.

BRAECK.

*Illustrated on Plate V.*

We this month present our readers with one of the most fashionable carriages at the present time to be found in France. It is what we would designate (pardon the expression) a duplex Braeck. For this draft we are indebted to our friend, Mr. F. Sherb, who has recently returned from a visit to Paris, where he has had opportunities for learning the latest fashions—a circumstance not always so favorable on this side of the Atlantic. The "hints" for the design are, doubtless, of English origin, and taken from Queen Victoria's cabriolet, which has proved a fruitful source from whence the Parisians have contrived their Pony-chaises, Godet-chaises, and some other styles of carriages now so much in vogue in France. The cane work should be done very fine. In France the painting is generally of ultramarine blue and the trimmings eoteline.

For the New York Coach-maker's Magazine.

SINGLE TOP BAROUCHE.

*Illustrated on Plate VI.*

RAHWAY, N. J., February 21st, 1859.

MR. EDITOR:—The inclosed draft of a Caleche we are not making. The sides above the quarters and doors are carved in imitation of basket-work, surrounded by silver mouldings. The draft will explain the remainder, and

should it be worthy of a place *above* the table, I shall be rewarded by the satisfaction I will experience in having done my share of pencil support, according to my abilities, for *our* Magazine, and if my thousand-and-one shopmates Down-East think they can do better, why, let them do so.

Yours, respectfully,

A. DUXBURY.

[We perhaps owe an apology to our correspondent, in not giving his valuable communication earlier, and can assure him, and some other kind correspondents, whose articles have not yet been published, that we try our best to please all. In explanation to those who have sent us drafts of heavy carriages, we would here state that the call from our patrons is for more light drafts. If light working drafts are sent us, and they possess any features of a novel character, they will be pretty certain to appear at an early day.—ED.]

For the New York Coach-maker's Magazine.

BUGGY WITHOUT A PERCH.

*Illustrated on Plate VII.*

This design is something making a change from the old style. A front carriage may be easily constructed with two pieces of hickory five inches wide, for the body-loop to rest on; the other to rest on the spring, with a horizontal wheel between them, secured with the necessary stays, &c. Some would prefer a higher front wheel, but it is preferable to have a wheel to turn under the body. J. I.

## Sparks from the Anvil.

DESIGN FOR A RAISED BACK STAY.



WE are indebted to our friend, Mr. E. Briggs, for the above design, for the support to the "lazy-back" of a buggy seat. It possesses some points of originality that will recommend it to the attention of those who are getting up fancy work, where the weight is not so much an object as the appearance.

CAST-STEEL.

A great improvement in the manufacture of this most useful article has been lately discovered in England. Formerly the process was long, tedious, and expensive, but by a late invention it is now made from the iron at a single operation. The inventor uses earthy materials in the state of oxyds or salts, placing them in the crucible in which the iron is placed, to be both cemented and melted into cast-steel. This must be a great saving in time and expense, and consequently ought to have a tendency to make the article cheaper.

## HOMOGENEOUS STEEL.

In our advertising department will be found a new article offered to the public, which is attracting considerable attention. This article possesses such an equality in the arrangement of the particles, and such equal qualities of toughness in every part, that it is well adapted to coach-makers' uses, for tires, axles, and springs, where lightness and strength in combination are required.

For the New York Coach-maker's Magazine.

## CIRCLE CARRIAGE-PART.

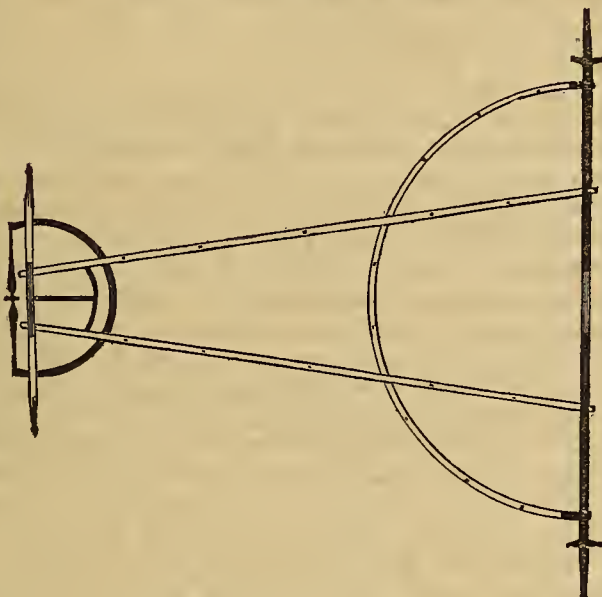

This is a great favorite in Raleigh, North Carolina. The circle is a half-rim worked down to five-eighths of an inch square. The perches themselves are made three-fourths of an inch square, and both the perches and circle are plated on the bottom, with iron one-quarter of an inch thick. When completed, it makes a very light and pretty carriage-part. I have put them under light Rockaways since I have been here.

B. H. HUESTIS.

## SMITH'S FIFTH-WHEEL.

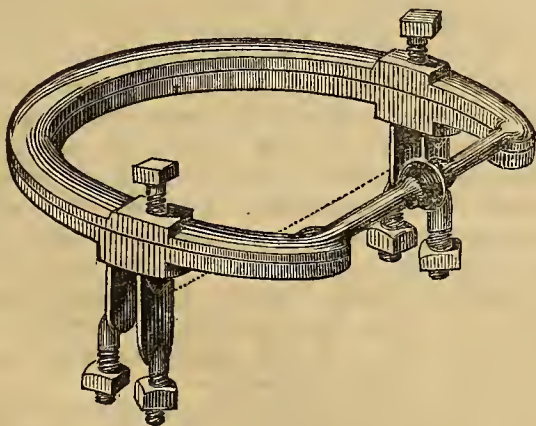

This Perch Coupling, or fifth-wheel, is used to connect the front Axle to the Perch.

Smith's Perch Coupling has the following excellencies:

1. It is made of good Wrought Iron, by a good workman, and will last as long as any carriage on which it is used.

2. It has all the advantages of an entire wheel, but is much lighter.

3. It gives a genteel and elegant finish to a carriage.

4. It is sold cheaper than the same article can be made in the shops.

The usual diameter of the Coupling is 14 inches, but we make any diameter to order.

Persons sending special orders, are requested to tell diameter of Coupling, length of Clip, and distance across the top of Axle bed, at the place where the Coupling is attached. These Couplings cost \$1.50 per set.

## TEMPERING STEEL TOOLS.

The following article on tempering steel tools we take from the *Scientific American*, furnished by a correspondent to that paper. It cannot but be useful to our readers:

There are some facts in the hardening, tempering, and heating of steel articles and tools that are not commonly known or attended to. All workers in steel are, very properly, more or less careful not to injure it by over-heating; but it may as certainly be deteriorated by a too-long continued or a too-often repeated moderate heat. Good, new steel, when broken, will exhibit an uneven, splintered fracture, which indicates toughness. This quality, by a repetition of moderate heats without hammering, or a prolonged heat (as in annealing), will, in a marked degree, disappear, and the steel is now without body—not brittle, but rotten.

I presume it is well known to machinists that a drill becomes worthless, if several times hardened and tempered without forging. The effect can be seen in the discoloration of the grain, its appearance being muddy and dead, and lacking the peculiar gloss and splintered texture of tough steel. In the hardening and tempering of thin saws the influence of time, as well as temperature, is often forcibly illustrated. For example, hand-saws will bear their teeth set at a given temper, but if (as sometimes happens) the saw is not sufficiently heated to harden when dipped in the bath, and it has to be re-heated, it will require to be drawn to a softer temper to admit of being set without breaking the teeth. The same pernicious effect occurs when the heat of the furnace is too low and requires extra time, and in a still greater degree if the saws are exposed to the flame of soft coal. It has been found that the toughness of the saw is in a direct ratio with the quickness of the heat and the clearness of the fire.

It is erroneously supposed by many persons that some sort of virtue is imparted to steel by being hardened in specific baths. With the exception of files and sheet-steel, clear water is the best hardening medium for about all kinds of tools. If the tool is of a slender form, the water should be heated to about 100° Fah., to prevent warping. Forged tools have their surfaces brightened to remove the scale before heating; they will then harden at a low heat and more regularly, and, as a consequence, will not be so liable to warp. For sheet-steel or small delicate tools, a bath composed of 1 gallon of fish-oil and 1 lb. resin, and made warm for use, is as good as, or better, than a more mysterious compound. It will strip off the scale of the steel, and make it harden uniformly and moderately, which is all that is required. Steel hardened in this liquid is of about the same degree of temper, without drawing, as it would be if drawn to a deep straw-color after dipping in water; and this should be allowed for accordingly, in fixing the temper.

## Paint Room.

For the New York Coach maker's Magazine.

### HOW TO PAINT A CARRIAGE-PART.

BY GEORGE P. TINKER.

*Continued from page 212, Vol. I.*

MR. EDITOR—*Dear Sir:*—The priming for a carriage-part should be the same as that for the body, and after the "gearing" is ironed, it should be sand-papered off smoothly, and dusted off cleanly, and a coat of the same paint applied as in No. 2, on the body, and after it has stood long enough to get dry it should be puttied. The putty should be mixed of whiting, raw oil, a little japan, and likewise a small portion of varnish. After the job is thoroughly puttied, it should stand twenty-four hours, and should then be sand-papered and dusted off again, in the before described manner, after which apply a coat of the same lead paint that we gave the body after the filling had been cut down. After this has stood forty-eight hours, it should be once more sand-papered, with very fine sand-paper, then dusted off clean and a coat of color applied, mixed the same as for a body. The gearing should have two coats of color, and forty-eight hours should be given to each to dry. When the second coat has become dry, you will apply a coat of the same color, adding one-half or two-thirds of gear varnish. After this has become dry, you will apply a coat of clear varnish. I generally (if there is any of the color and varnish left of the previous coat) add enough varnish to give the gear another coat of color and varnish, although there is but very little color in the last coat; after this last coat has become dry, you will take a handful of curled hair, or a piece of hair-cloth—and if you can't get either of these just take a very fine piece of sand-paper—and rub over the work, in order to smooth down the lumps.

Now is the time to stripe and ornament the gear. After this has become dry, you will apply a flowing coat of varnish; and if it is an extra fine job, after it has stood five or six days, you will rub it down, and apply another flowing coat of varnish. When I get ready to apply the second coat of color, and before varnishing, I always wring out my buckskin cloth in clean water, and with this I wipe the job, and by so doing I remove the dust that the duster will not move, and it moistens the surface, so that the varnish spreads easier, and adheres quicker. Now for the proof of this: put the second coat of color and varnish on the gear, and let it stand two or three weeks in a shop that is a little cold; then dust off your job, and attempt to stripe it and you will find that, as you draw your pencil along and make a line, the paint runs on, smooth and nice; but about the time you draw your pencil eight or ten inches, the paint will draw and run up into drops, and look as if the surface had been greased, and you had thrown some water on it. Now, take the dampened skin and wipe the gearing, and try the project again, and you will see your stripe runs on and adheres beautifully; and we think this plan indispensable previous to the last coat, especially if our room is a little dusty. When I am about to apply the last coat, I commence and dust off, say, the two near side wheels, then I dust off the gearing; after which I wipe off the two wheels with the skin; then I dust off the other two wheels, and wipe them and the gear-

ing off with the skin; then I commence by applying the varnish to the two first wheels dusted and wiped.

The floor should always be dampened previous to dusting off the job. And here again you see the necessity for using the skin, as in sprinkling the floor it will spatter up on the feloes and spokes more or less, and it won't dust off clean with the duster; but when the dampened skin passes over it, it all vanishes as does the dew before the rays of the morning sun. Another thing I always do, invariably, that is, I coat the wheels first, unless it is a large and heavy job that requires much hard lifting, then I set a trussel under each axle and then each wheel will turn. It is the better way then to commence on the gearing, but for a light job I prefer raising the two wheels on a side at once, as when I come to striping I can take advantage of the gear that I could not do were it mounted on two trussels. There are as many different modes of painting carriages, almost, as there are different kinds of carriages. I once knew a painter that only gave a job one coat of lead paint, after ironing, then to putty the job; when the putty was dry, sand-paper off the job, and apply one coat of color ground in turpentine; then he added about half a tea-cupful of dryer to every pint of paint, and, if he was not in a hurry, he added about two table-spoonfuls of raw oil. This coat, if it were black, when dry, would be about the color of the soot that collects in the chimneys of houses. After this coat became dry, he ground some more color thin in turpentine; then he added about three parts varnish to one part paint. With this he would give the job a flowing coat, and if it was a fine job he would give it two coats of color and varnish, adding more varnish in the last coat.

It would take these coats about three days to dry between each coat. After the last coat was dried and striped, one flowing coat of varnish would finish the job. This way of painting a carriage will do for repainting old jobs that are painted entirely black; but for jobs that require different colors, it would be better to give the job two or three coats of color, and one clear coat of varnish.

There are a great many painters who manufacture their own japan, although it has become the prevailing fashion for proprietors to furnish the japan; therefore the painter is not put to the trouble of making his own, and it was owing to the extensive use of japan that I did not give you some receipts for dryers. I never used but one and a-half gallons of bought japan in my life, yet, there are a great many painters who look upon those who make their own japan, as belonging to the old podauger fraternity; yet I must say that the very great portion of shellac, in a dryer, is one of the greatest bores—litharge not excepted—that is used in carriage-painting. I will give you a receipt for a dryer, and it is one that will mix well with oil, or it will mix well with varnish, and it is free from either a harsh, gummy, or sticky nature. Now, japan that has gum-shellac in it, will not dissolve and mix with raw linseed oil, but this will. It will mix in less time than will oil and varnish. It is as follows:—

Take one gallon of raw linseed oil, one pound of red lead, same of raw umber, and eight ounces of sugar of lead. Take a kettle that will hold double the amount you wish to boil, and pour in the oil, and let it come to a simmer, and then add the above ingredients. The red lead and the umber should be pulverized and put into an old pan or skillet, and burnt for fifteen or twenty minutes previous to being put into the oil; then it should boil for three

hours, after which it should be set off the fire and left to cool about fifteen minutes; then add one gallon of turpentine, and after it is sufficiently cool, it should be poured into a tin can, and is then ready for use. This works more free in oil colors than any other dryer that I have ever used. It is of English origin, but is none the worse for that, for we are indebted to England for many good inventions, for which we should be thankful. The first railroad car that was ever painted in the city of Chicago, Ill., the painter made use of this very dryer in mixing paint.

### Trimming Boom.

#### HARMONY OF COLORS, IN LINING CARRIAGES, WITH THE COMPLEXION AND DRESS.

IN the volume of *Hints to Horse-Keepers*, noticed in another part of this volume, we find the following *sentimental* "laws of harmony" as applicable to the linings of carriages, and the complexions and dresses of ladies, which, in some cases, *may be* useful to our readers, and which, as the fanciful writer intimates, ought to "*be appreciated.*"

"Blue-colored linings, in a carriage, harmonize with the complexion of a *blonde*, while they impair the beauty of a *brunette*; and with a crimson dress or shawl, blue is decidedly inharmonious.

*Crimson* in the trimmings suit well the complexion of either blonde or a *brunette*, but the dress should not have blue as a predominating color.

*Brown trimmings* are suitable for a *brunette*, and agree with green drapery on the person.

*Green* in the carriage demands warm tints in the dress, and is then harmonious with all complexions.

*Drab* agrees well with all colors in the dress, and with all complexions.

The above "laws" we look at as being decidedly more *fanciful* than practical; but since it has become fashionable to reward originators of new ideas, we commend this author to the attention of the ladies, especially.

In some "hints on colors," the writer says, a carriage painted green should never be trimmed with blue cloth, but drab, crimson, brown, or claret. If the body is blue, it should not have green trimmings, but either blue, drab, or gray. He tells us, bodies painted either claret or lake, may be trimmed with almost any colored cloth—blue being the least desirable.

Blue linings require a carpet of blue and claret, blue and gray, or two shades of blue; drab linings look best with blue crimson or green carpets. Green linings harmonize with carpets of crimson, or crimson and green.

Claret linings should have a carpet of green or crimson, crimson and black, or crimson and claret.

Brown linings require brown and blue carpets, brown and green, or green and black. The same rule is also made applicable to the laces used.

We would commend these "rules" to the attention of our readers, and think that the "hints," as regards their harmony in painting and trimming, will be found very useful. Those who desire the book from which we have compiled the hints, are referred to our literary notices on another page.

#### STITCHING.

THE larger portion of buggies, now ordered made by customers in New York, are trimmed with figures stitched in black. Occasionally, however, we find a customer who is still a favorite of white stitching. We think the indications are, that white will soon entirely go out of fashion. The public taste is evidently inclined to choose a plainer style of work than has been in vogue for the past five years, particularly when applied to the finer descriptions of carriages.

### The New York Coach-maker's Magazine.

JULY 1, 1859.

E. M. STRATTON, Editor.

#### TO READERS AND CORRESPONDENTS.

*All letters directed to this office on business, NOT relating to the Magazine, but solely for the writer's benefit, must inclose a stamp; if requiring an answer, two red stamps. Orders for a specimen number must be accompanied with nine three-cent stamps. When these terms are NOT complied with, no attention will be given them.*

OUR RULE.—*All subscriptions terminate with the numbers for which advance payment has been made. Those wishing to continue will, therefore, see the necessity of renewal, by sending in the money in time. We intend to regulate our Edition of the SECOND VOLUME as near the wants of the craft as possible, so that an early order is desirable.*

AGENCY—TO COACH-MAKERS.—The publisher of this Magazine offers his services to fill orders for any article *his friends may want, to be found in the New York market, FREE OF CHARGE, where the individual is a subscriber. None but orders inclosing the cash are invited. Letters of inquiry MUST contain two red stamps.*

W. L. B. & Bro., ALA.—Your order found us and neighbors so busy, that we could not get the work done in time to our satisfaction.

M. L. P., GA.—We have attended to your requests, and sent bill of cloth by mail. We feel ourselves indebted to you for the names and remittance sent us.

H. D. S. & Co., OF CONN.—The wood-cuts have been sent as directed, by express.

M. B. MCK., OF LA.—M. J.'s case is not the only one where *his* old friends have been imposed upon. We know of some who did not even get "a few old copies."

L. E., OF N. H.—We cannot send the Magazine until advance payment is made. This obligatory rule is necessary to our success.

H. H. T., OF N. Y.—Your criticism is just—the top is about three inches too low. Thanks for your kindness in sending the club.

P. R. S., FIRE ISLAND, TEXAS.—We never had anything to do with publishing *The Harness-maker's Journal*. It has been "dead" some eighteen months, and never had much *vitality* about it.

I. H. P., OF GA.—We told you so more than a year ago. We are sorry to find "the proof of *its* honesty" so questionable.

## THE NATIONAL BIRTHDAY.

WE presume that before the annual return of that day which every true American will delight to honor with patriotic speeches, the explosion of gunpowder, and other appropriate demonstrations of joy, this number of our Magazine will be in the hands of its readers. We shall, therefore, anticipate the return of our national anniversary with a few reflections.

The general prostration of business, particularly everything mechanical, and consequent unhappiness—which must always have a tendency to lessen the patriotic ardor of a sensitive people—that seemed to prevail one year ago, we are happy to find, is rapidly passing away. With the returning prosperity, the craft will find many reasons for rejoicing and encouragement. Notwithstanding that, with a few, carriage-making has not been all that was hoped for, still, with the majority, it has been such as to prove very satisfactory. We have received numerous advices in proof of the fact. In the New England States particularly, the business has been encouraging. The demands for the Southern and home trade have revived the energies of an ambitious and active population, which, consequently, has brought along with it happiness and contentment—two very essential requisites in the national cup of rejoicing. In the West, where agriculture is the principal dependence for support, it has been quite different, but from the reports which have reached our ears, we have much reason to hope that, in view of the demand upon us for the great staples of the country, caused by the warlike and cloudy aspect of affairs in Europe at the present moment, it will soon change the aspect of affairs for the better. With strong hopes, then, of prosperity looming up in the future, let us together rejoice in the firm belief that we are still the happiest nation on the face of the earth, and that liberty, justice, virtue, and happiness are only to be found

“Where the star-spangled banner in triumph *does* wave,  
O'er the land of the free and the homes of the brave,”

while tyranny, fraud, corruption, and misery rule undisputed in every other portion of the globe. In the cultivation of these sentiments we shall, doubtless, find that our *amor patria*—love for our own country—will become proportionably enhanced, although we may be forced sometimes to believe that there are many things which might be improved upon.

Perhaps some philosophical observer from abroad may be astounded at the gross inconsistencies presented in the professions and conduct of our people. There are many who, in a popular declamation on the inalienable rights of man, the inviolability of the immunities granted to us by our national Constitution and laws, and the invariable reverence of freemen for the majesty of laws, go away delighted with the orator, our institutions, and themselves, but who, in a short time, are found tarring and feathering

some unfortunate wight who has the misfortune to differ in opinion from them in some political or other question of the day. These forget that they are persecuting a man for that very exercise of his reasoning faculties for which our forefathers bled and died on the field of battle, and for which they themselves profess to contend. The shamelessness of such incongruities, although sickening to a well-educated mind, are yet none the less true, and although some ardent politician may sooth us with the healing persuasive that public opinion will some day correct the evils which now afflict the community, we very much fear that public opinion is itself in a morbid and sickly state in some localities.

But we had no design, when we commenced this article, to make a political speech, or to write a homily on matters connected with national inconsistencies; we shall, therefore, merely add that, in the hope that our friends will find in the return of the day that happiness and enjoyment they may reasonably expect, we leave this subject for the present.

THE CARRIAGE-BUILDER'S AND HARNESS  
MAKER'S ART JOURNAL.

By the arrival of the *Africa* from England, on the 9th ult., we are in receipt of the following letter and prospectus of a new work similar to our own. The letter, which we give entire, is calculated to mislead our readers, and therefore needs a little explanation. We are not a “little” surprised to hear that our “work is but little known in England,” when for an entire year our Publishers in London—the Messrs. Trübner & Co., 60 Paternoster Row—have extensively advertised our Magazine, and obtained for it a number of subscribers. It is not the less surprising, when we reflect that this having been done in the immediate vicinity of our new-born contemporary, yet the knowledge of our existence has but just reached “21 Warwick Square, Paternoster Row.” Verily, the age of “slow coaches” is not entirely abrogated. We have accepted the propositions contained in the letter, and trust that the “exchange” will be beneficial to both parties. We shall again notice the work when the first number reaches us.

To the Proprietor of the *New York Coach-builder's [maker's] Magazine.*

21 WARWICK SQUARE, PATERNOSTER ROW, }  
LONDON, E. C., May 27, 1859. }

SIR—We are about to publish a monthly journal for Coach-builders and Harness-makers, something on the plan of the Magazine published by you, although at the time we projected it we had not heard of yours: indeed, it is but little known in England; very few of our builders have ever heard of your work.

As the one will not at all clash with the other, we shall be glad to exchange advertisements (ours we inclose), and we shall be willing to extend the sale of your Magazine to the utmost in our power. We shall be much obliged to you for any information respecting the trades in the United



States you may be disposed to favor us with, and if we can inform you of any news respecting the trades in England, we shall be happy to send it.

Hoping for the favor of an early reply,

We remain, Sir,

Your obedient servants,

TALLIS & Co.

Now publishing in *Monthly Parts* (Royal 4to, price 2s. 6d. each),

THE CARRIAGE-BUILDER'S AND HARNESS-MAKER'S ART JOURNAL, giving practical directions in all branches of Coach-building, Saddlery, and Harness-making, with working drawings and colored illustrations.

CONTENTS OF PART I., PUBLISHED JUNE 1ST, 1859.

*Illustrations.*

- 1.—Dress-Coach built for the King of Prussia, (colored)
- 2.—Light Sporting Cart, do.
- 3.—Sociable Landau, do.
- 4.—New patent for carriage, front elevation, (outline)
- 5.— do. do. side elevation, do.
- 6.— do. do. in full look, do.
- 7.— do. do. straight, do.
- 8.—Brougham Body with Cant Board, do.

With 16 pages of descriptive letter-press.

NEW YORK: D. Appleton, Broadway.

LONDON: Tallis & Co., 21 Warwick Square, Paternoster Row.

OUR ADVERTISERS.

SOMETIME since we called special attention to the cards of our friends, who then occupied some portion of the advertising department of this work. Since that issue, we have been favored with the subjoined list, to which we now invite attention :

- AXLES.—A. H. Bonnell & Co., Newark, N. J.
- AXLES.—J. M. Post, Newark, N. J.
- AXLES.—Samuel Mowry, Greenville, Conn.
- AXLES AND SPRINGS.—Tomlinson Spring and Axle Co., Bridgeport, Conn.
- AXLES AND SPRINGS.—Spring Perek Co., Bridgeport, Conn.
- BENT STUFFS.—J. B. Kilburn, Newark, N. J.
- BENT STUFFS.—Smith & Barlows, Bridgeport, Conn.
- CARRIAGE WOOD WORK.—Wm. T. Seranton, New Haven, Conn.
- CARRIAGE WOOD WORK.—Dann Bros., New Haven, Conn.
- CARRIAGE TRIMMINGS, &c.—J. M. Tuttle, New York City.
- CARRIAGE TRIMMINGS, &c.—M. B. Valentine & Co., New York City.
- CARRIAGE TRIMMINGS, &c.—C. C. Dusenbury, New York City.
- CARRIAGE TRIMMINGS, &c.—F. S. Driswell & Co., New York City.
- CARRIAGE TRIMMINGS, &c.—W. F. Shattuck, New York City.
- CARRIAGE TRIMMINGS, &c.—J. P. Jube & Co., New York City.

CARRIAGE TRIMMINGS, &c.—D. B. Turnbull, Newark, N. J.  
CARRIAGE TRIMMINGS, &c.—C. Cowles & Co., New Haven, Conn.

CARRIAGE TRIMMINGS, &c.—Thos. P. White & Co., Bridgeport, Conn.

COACH LACES.—Charles H. Pardee, New Haven, Conn.

COACH LACES.—Bridgeport Lace Co., Bridgeport, Conn.

ENGRAVER ON WOOD.—Wm. H. Redman, New York City.

FILES (re-cutting).—J. F. Anderson, Haverstraw, N. Y.

FRINGES, CORDS, TASSELS, &c.—G. Rowden, Newark, N. J.

GERMAN SILVER WARE.—Bromley & Prosser, Newark, N. J.

GERMAN SILVER WARE.—Arnold Stivers, Newark, N. J.

HOMOGENEOUS STEEL, &c.—G. W. Billings, New York City.

HOMOGENEOUS STEEL, &c.—Shortbridge, Howell & Co., New York City.

HUBS.—A. Russell, Newark, N. J.

HUBS.—Wm. Miles & Co., Newark, N. J.

NAME PLATES.—D. W. Thomas, New York City.

PATENT ADJUSTABLE CARRIAGE-SEATS.—George & D. Cook & Co., New Haven, Conn.

PLATING, (SILVER).—J. H. Gardiner, New York City.

SHAFT-COUPPLINGS.—C. Van Horn, New York City.

SHAFT-COUPPLINGS, SLATT-IRONS, &c.—H. D. Smith & Co., Plantsville, Conn.

SPOKES.—C. A. Carter, Newark, N. J.

SPOKES.—Elizabethport Steam Manufacturing Co., Elizabethport, N. J.

STITCHING MACHINES.—I. M. Singer, New York City.

VARNISHES, (COACH).—Hedden & Fitz-Gerald, Newark, N. J.

VARNISHES.—Pierson & Robertson, Newark, N. J.

VARNISHES.—Thompson, Price & Co., " "

VARNISHES.—D. Price & Fitzgerald, " "

VARNISHES.—S. P. Smith & Co., " "

VARNISHES.—Moses Bigelow, " "

VARNISHES.—Stinson, Valentine & Co., Boston, Mass.

WHEELS.—Naugatuck Wheel Co., Naugatuck, Conn.

" (For Superintendent,) W. P. Leslie.

WHIP-SOCKETS.—J. W. Munson, Bridgeport, Conn.

The above manufacturers and dealers in the various articles named, we have found to be gentlemen with whom it is pleasant to do business. A large proportion of them have advertised with us since we first undertook this enterprise. We confess that, in soliciting their patronage for another year, we had the agreeable satisfaction of learning that *our* friends, during the past year, did not suffer them to advertise in vain. Many of them said they had been well repaid for their outlay in advertising. There was, however, a little *discount* on the "agreeable," where, as was in a few instances the case, we found our former advertisers had so much business in consequence, that, "to advertise longer, at present, would only be to complicate a

business in which they already had more orders than they could well fill." As we never like to see people *in trouble*, of course we had no heart to urge upon them a continuance of their favors to us. Others were so well satisfied, that they have ordered their cards enlarged, in expectation that the benefits to be obtained, will be proportionately increased. We hope their expectations will be met, and have no doubt that they have taken the surest course to attain their object. Should there be any who are grumbling, because business is dull, we recommend them to go and do likewise. We have no hesitation in asserting that ours is the best "medium" on earth for reaching coach-makers. To accommodate our friends, we are ready to add any number of pages they may require to give their advertisements, so that no one need stay away, thinking that our pages are already full.

#### TO THE FRIENDS OF THIS ENTERPRISE.

WE would respectfully ask of those who are now taking this volume, that they would take the trouble to show it to their friends, bosses, journeymen, &c., and endeavor to get them to subscribe. We asked the same favor last year, and in response we received such encouragement as sent us on through the volume rejoicing. We have tried our best to redeem our promises to the public, and we think, should our friends—which we are happy to find are many—only take a little more interest in our Magazine this year, and gratuitously add one or two names to our list, they would find their interests promoted in the improvement we should be able to bestow on our publication. There are many who are not accustomed to write for the press, but yet are original and ingenious mechanics. Especially in the trimming department would we solicit communications from the craft. Where payment is demanded, and the article is valuable, we will cheerfully remunerate the writer. We commend the above to the attention of our friends, at the same time returning our best thanks to such as have the past year enriched our pages with their valuable favors.

#### BINDING THE MAGAZINE.

WE are requested to say that our binder—Mr. H. Stocking, of No. 14 Frankfort street, New York—has prepared some handsome and appropriate designs for the cover of this work, and that he is now prepared to execute any orders our friends may feel disposed to favor him with. This he will do for 75 cents a volume in cloth, gilt, and lettered; or half bound in muslin, or full sheep plain, for \$1. To those wishing them, we would say that he will supply covers in cloth at 44 cents, so that any binder in your locality will be able to put your volumes in one uniform binding. We can still supply odd Nos. for 25 cents each to those who may want, with the exception of the Novem-

ber No. We would suggest to those who last year took our volume in clubs, that they put their volumes up in one package and send them by express, altogether, to Mr. Stocking, who, when he has them bound, would return them by the same conveyance. The charges, in such cases, for transportation, being borne by different individuals, would make it light to each.

We have had a supply of our first volume bound up, which we are selling for \$3.50, postage paid to any part of the United States. They are bound in muslin, with carriages on the side and back, in gilt, and other appropriate designs, making it a desirable and useful book, either for the parlor or workshop.

THE NEW YORK HACKMEN UNDER INSPECTION, ETC.—From about the 6th to the 20th of June, annually, according to statute, the city hackmen are called upon to renew their licences, without which they are subject to a fine of ten dollars. According to annual custom, Messrs. Quick & Davis, Hack Inspectors, took their stand and *opened* an office in the park, under a tree, at the southeast corner of the City Hall, on the morning of June 6th. The furniture of the open-air-office would have been becoming the interior of a log-cabin in the days of hard-cider, being rather of the primitive order of architecture—a common pine table—on which reclined a big book, containing the names of more rascals, and the Nos. of more hacks, than can possibly be found in any other volume in America. The inspectors, having taken a *standee* seat at the corners of the table, proceeded to business; this ancient mode of doing things entirely doing away with the necessity of Paddy's going into the City Hall, and leaving his "carriage" while getting out his license. While one is doing the "inspecting," the other finds *steady employment* in driving away Young New York, who is staring at, and passing his remarks on, the "mysterious" folio and the big brass figures, two inches long, at least, which are being shown as a sample to the interesting-looking Jehus, and which they are ordered to have emblazoned on the rocker of their coaches. Paying down \$5 on the spot, at the time indicated, entitles them to all the rights and privileges the law allows (and in which are included some they allow themselves), for one year. The city revenues are, by this means, increased about \$3,500, which amount will be "evaporated," before the year ends, in feeding City Hall *rats*, without any benefit to those outsiders composing the great mass of the honest and industrious classes. So it goes! We are a great "peoples!"

THE SINGER SOCIABLE.—Our neighbor, of sewing-machine notability, is having made, at Messrs. Fred. Wood & Co.'s, in Bridgeport, one of the largest and most curious vehicles we have ever seen or heard of. To do it full just-

ice by an attempt at description, is out of our power. In its present state, it looks very much as though it were designed for a *traveling villa*—part coach, part coupé, and part omnibus. If our friends can give us a better description, we shall be pleased to have it.

The following are the instructions for finishing this sociable: The panels are to be painted light yellow; coupé and blinds, blue; carriage, yellow, black, and blue; linings, yellow coteline; black and straw colored lace; hammer cloth, blue cloth; fringes, blue and gold, very strong; the plating, silver. The sociable is to have heavy cord and tassels, and to be finished by the 15th of this month, and if it does not prove a *rara avis*, then, as the Yankees say, "we have missed our guess."

#### LITERARY NOTICES.

 Books or publications of any description designed for notice in this column, should reach us by the tenth of the month preceding the date of our issue.

**HINTS TO HORSE-KEEPERS:** a Complete Manual for Horsemen—embracing how to breed a horse; how to buy a horse; how to break a horse; how to use a horse; how to feed a horse; how to physic a horse (allopathy and homœopathy); how to govern a horse; how to drive a horse; how to ride a horse, and chapters on mules and ponies. By the late Henry William Herbert (Frank Forrester). With several additional articles, including directions for the selection and care of carriages. New York: A. O. Moore & Co., 140 Fulton street. Price, \$1.

Such is the modest title of a very interesting and prettily got up work, intended to include every subject of interest to those who, for pleasure or business, own or use a horse. It is not intended by this publication to supplant more elaborate works, yet its comprehensiveness must commend it to the favor of the public, by which, as we learn, it has already been well received.

The chapters on carriages and harness will prove very useful to those who are able to "keep a horse" and carriage (among whom we do not include ourselves), since they will find here some valuable instructions, how to buy, and take care of a carriage or harness afterward. We cannot well see how a purchaser can very easily be "taken in," with either horse-flesh or carriages, should he follow out the "hints," here laid down in the most simple manner. The work is very profusely illustrated with fine engravings, appropriate to the subjects treated of.

*Hints Toward Physical Perfection*; or, the Philosophy of Human Beauty—showing how to acquire and retain Bodily Symmetry, Health, and Vigor; secure Long Life; and avoid the Infirmities and Deformities of Age. By D. H. Jacques. New York: Fowler and Wells, publishers, 308 Broadway. Price \$1.

This is a work which, if we mistake not, is destined to

command almost universal attention, and awaken everywhere a deeper interest in the physical improvement of the human race than has yet been manifested; as it shows how certain and easy this improvement may be made by the use of the perfectly legitimate means therein pointed out. Its revelations of the laws of human configuration, on which symmetry and beauty depend, are not less interesting and important than they are novel and surprising; showing, as they do, that the form and features of even the mature man or woman (and much more those of the child) may be modified at will, and to an almost unlimited extent—that we have the power to change, gradually but surely, the shape and arrangement of bone, fiber, and fluid, thus growing, day by day, more beautiful or more ugly, according to the direction given to the vital forces.

It will be found deeply interesting to both sexes (but especially to women) and to all ages; and we earnestly commend it to all for whom health, strength, and beauty have any attractions; to parents, as a guide to the right performance of their all-important functions and duties; to teachers, who may learn from it how to develop the minds and bodies of their pupils harmoniously together; to young women, who will not look in vain in its pages for the secrets of that womanly beauty and personal attractiveness which they very properly desire to possess; and to young men, who will find it a manual of rules for the development of those high qualities of physical vigor and manliness which will command the admiration of their own sex no less than the love of the other. Illustrated with twenty plates and a large number of cuts, executed in the highest style of art.

*Life Illustrated* is the name of an interesting first-class weekly Pictorial Newspaper, published by Messrs. Fowler & Wells, the well-known Phrenologists, at 308 Broadway, at \$2 a year. One of the chief excellencies which distinguishes this publication from many of its contemporaries is, that it deals more in the real than the ideal affairs of life. This circumstance alone commends it to the hearts and homes of all good citizens throughout the land.

*Godey's Ladies' Book* has, with the June number, just closed another volume. We advise all our readers to read the article in the last volume, on "Miss Slimmens's Window," and we think it will not fail to put them in humor to subscribe for the volume commencing in July, especially as the same author commences another article with the half yearly volume. Published in Philadelphia by L. A. Godey, at \$3 per year, in advance.

From the Philadelphia "Daily Press."

In the *New York Coach-maker's Monthly Magazine*, we gladly recognize a great deal of ability. It is an illustrated work, containing much information, likely to be advantageous to *buyers*, as well as *makers* and *vendors*, of carriages. We have been especially pleased with a well-written, highly interesting biography of our townsman, Mr.

William D. Rogers, whose establishment, in Chestnut street, is well-known. Mr. Rogers is a living example of successful industry, enterprise, and probity, and we are glad to find that he has a biographer who does him justice without once running into flattery. We shall respect the coach-makers more than ever, in future, for having such a magazine as this.

### Editor's Work-bench.

**BACHELORS AND MATRIMONY.**—The "Assurance Magazine," an English periodical, has the following very discouraging statement for the consideration of those who, up to this time, have reveled in "single blessedness." We wish our sage contemporary had gone a little further, and enlightened us upon the "chances" as respects that much-abused class denominated "old maids." Probably, he considered their chances so small, that they were not worthy of notice. But listen, ye miserable of the sterner sex, and be wise—*before you are too old!*

"We are told that in the two periods of life—20 to 25, and 25 to 30—the probability of a widower marrying in a year is nearly three times as great as that of a bachelor; at 30 it is four times as great; and from 30 to 45 it is five times as great; at 60 the chance of a widower marrying in a year is eleven times as great as that of a bachelor. After the age of 30 the probability of a bachelor marrying in a year diminishes in a most rapid ratio; the probability at 35 is not much more than half that at 30, and nearly the same proportion exists between each period of five years afterward."

**A COACH-MAKER'S MISFORTUNES.**—An unfortunate "brother-chip"—whose name, for certain reasons, we withhold—from "way down South," in Georgia, had occasion to visit New York, a few days ago, to replenish his stock of materials for carriages, and to see the "sights," which these "diggin's" present to strangers. Thinking from his appearance that our Southern friend would not object to the attentions of a gentlemanly cicerone, a smart chap about town invited him to accompany him on an excursion down the bay to Staten Island. On arrival at the Quarantine Grounds, after having pointed out to his victim the seat of the late "Sepoy War," etc., the fellow had so far ingratiated himself into the charitable feelings of the Georgian, that he very easily swindled him out of \$195, by means of the patent-safe game. We mention these facts, so that our friends, who may come here to "see the elephant," may become somewhat educated in natural history, before they leave home, since its study is rather expensive in Gotham.

**CELESTIALS GOING IT "FAST."**—Podgers, who does up the California matters for a New York journal, says: "It does one good to see how rapidly the Chinamen are be-

coming civilized, under the tuition of Young America, hereabouts. I saw four of them coming home from a dash out on the road yesterday, behind a pair of fast horses, all very drunk, smoking segars, and giving other evidence of progress. The one that was driving made a ludicrous fist of it—he persisted in standing up in the carriage, and putting one foot on the dash. A Chinaman behind was hauling taught on the pigtail to steady him, and they were in a high state of enjoyment, going it at 2:40 gait. Speaking of Chinamen, a funny scene took place in the Police Court the other day. About fifty Celestials were hauled up for fighting—that is fifty were arrested to enable the officers to find one fellow who *had* been fighting; but they all answered to the name of John, and moreover looked so much alike, that it was as difficult an operation as counting the Paddy's pig. One of them spoke English, and was interrogated as follows:

*Lawyer.*—Where were you?

*Chinaman.*—Me up stairs.

*Lawyer.*—How did you get there?

*Chinaman.*—Him go up a steps.

*Lawyer.*—Was there a great crowd in the house?

*Chinaman.*—Yes; two, three, fifteen.

*Lawyer.*—Was the house full inside?

*Chinaman.*—No; house full outside!

The lawyer didn't ask John any more questions, and the case was dismissed."

**A STEAM WAGON.**—Sandford W. Northrup, of Stanfordville, in Dutchess county, New York, is building a steam wagon, to run between that place and Poughkeepsie. He expects to carry five tons of freight, with a speed of six or seven miles an hour, a distance of eight miles, and back, with a cost of less than \$1.50 for fuel.

**A SMOKER TAPERING-OFF.**—The following is as good an illustration of the difficulties that attend the leaving off old habits, particularly that of smoking, as we have seen recently: "The Buffalo *Advertiser* tells of two chaps in that city, who recently resolved to give up smoking. They decided to taper-off, limiting the first day's consumption to three, the second to two, and the third to one cigar. One gentleman, however, thought that he had been hasty, but determined to keep his bond, as a bran-new tile was the penalty for overstepping the prescribed limits, and also to get as much smoke as possible during the tapering-off process. So he procured a cigar-maker to make him three segars, each twelve inches long, for the first day's use, two of eighteen inches long for the second, and one of thirty-six inches long for the third day." That last one is a little extravagant.

THE crowded state of our columns this month, obliges us to lay over a page of patented inventions. They will be given in the August number, together with other matter of deep interest.



**THE TIMES AND THE FASHIONS!**—The scene depicted by our artist, is supposed to be a common one, exhibited almost any evening, "about these times," by the Flora McFlimseys of the Fifth avenue, in New York city. There appears to be but two remedies for the evil: one is to adopt Bill Jingle's mode of constructing coaches, as described on page 56 of our first volume, or else for the coach-makers to alter the doors of all vehicles so as to be at least three feet wide. Either plan will accommodate the ladies, and, what is of no little importance, make business for "the craft."

"WHAT a strain that is," said Mrs. Partington, as she heard an aria from Lucia sung in the highest style by a young lady where she was visiting. "Yes," was the reply, "that is operatic." "Upper attic, is it?" said she; "I should think it was high enough to be on top of the house."

A WESTERN editor says his attention was first drawn to matrimony by noticing the skillful manner in which a pretty girl handled a broom. A brother editor remarks that the manner in which his wife handles a broom is not so pleasing.

GEORGE COLMAN, getting out of a hackney-coach one night, gave the driver a shilling. "This is a bad shilling," said Jarvic. "Then it's all right," said George, with his inimitable chuckle; "your's is a bad coach."

"WILL you give me that ring?" said a village dandy to a lady; "for it resembles my love for you: it has no end." "Excuse me, sir," was the reply, "I choose to keep it, as being emblematical of mine for you; it has no beginning."

"SAM, I've lost my watch overboard; it lies in twenty feet water: is there any way to get it?" "Yes, of course, there is." "How, Sam." "Why, divers' ways, to be sure."

A GENTLEMAN in New Orleans was agreeably surprised the other day to find a plump turkey served up for his dinner, and inquired of his servant how it was obtained. "Why, sar," replied Sambo, "dat turkey has been roosting on our fence tree nights, so dis mornin' I seize him for de rent ob de fence."

"MA, has aunty got bees in her mouth?" "No! why do you ask such a question?" "'Cause, that leetle man, with a heap o' hair on his face, cotched hold of her, and said he was going to take the honey from her lips, and she said, 'well, make haste!'"

A MAN was waked in the night, and told that his wife was dead. He turned over, drew the coverlet closer, pulled down his night-cap, and muttered, as he went to sleep again: "Ah! how grieved I shall be in the morning."

THE wives along the Mississippi river never *blow up* their husbands. They leave it all to the steamboats, which are sure to do it, sooner or later.

WANTED—A WHEELWRIGHT, to superintend the manufacture of hubs, spokes, felloes, &c., by machinery, in Claiborne, Ala. For an energetic man, who understands making wagons and carriages, good wages will be paid.

Address, W. P. LESLIE, *Claiborne, Ala.*



## G. & D. COOK'S PATENT ADJUSTABLE CARRIAGE SEATS.

This arrangement for adjusting Carriage Seats was Patented by **GEORGE & DAVID COOK**, of New Haven, Connecticut, February 3d, 1857.

They are adapted to almost any style of Carriage—can be used on a crooked as well as a straight body—and are at present being used extensively throughout the New England States, on light Rockaways as well as all styles of Open and Top Buggies. The peculiar merits and advantages of this invention over the ordinary sliding-seat, or in fact any other mode of adjustment, consist,

- 1st. That the seats are perfectly secure and firm in either form, without the use of thumb-screws or bolts.
- 2d. They can be changed from a one to a two seat carriage, and *vice versa*, by any person, in less than five seconds.
- 3d. Their construction is such there is no possibility of rattling.
- 4th. They are so simple in their construction, that they do not get out of repair.
- 5th. The perfect symmetry of the Carriage is preserved in either form, so that when in one seat form, no one unacquainted with them would ever think there was another seat concealed.
- 6th. The manner in which they *jump* instead of sliding, is such, that in changing them the paint is not marred or scratched. In short, the simplicity, ease of construction, durability, and lightness, together with the most perfect principle heretofore introduced, must necessarily commend itself to Carriage-makers generally, and at once take the precedence of all other modes of adjusting seats now in use.

During the past two years we have made and sold over *four hundred* of the Jump-seat Buggies, and have never yet heard the first complaint in regard to their operation, but on the contrary we have many recommendations, a few of which we submit, on the opposite page. We also refer parties, wishing to know more about the merits of the Jump-seat, to the following persons, who have bought many of us during the past two years:

G. & D. COOK & CO.

### REFERENCES.

JAMES B. BREWSTER, Broadway, New York.  
 E. M. STRATTON, Editor Coach-maker's Magazine, New York.  
 G. C. DICKERMAN & CO., Natchez, Miss.  
 D. E. HULL, Talahassee, Fla.  
 BARLOW & CO., Canton, Miss.  
 L. CHAPIN, and all other Carriage Dealers, Charleston, S. C.  
 W. F. TUNNARD, Baton Rouge, La.  
 OUTHWICK & SON, Galveston, Texas.

A. W. FORWOOD, Lexington, Ky.  
 R. H. MAY & CO., Augusta, Ga.  
 G. D. & J. G. ENGLISH, St. Louis, Mo.  
 WHITTIER & POYEN, and all other Carriage Dealers, Boston, Mass.  
 C. P. KIMBALL, Portland, Maine.  
 SANDERS & SOUTHARD, Newark, N. J.  
 DENMAN & CO., Rahway, N. J.



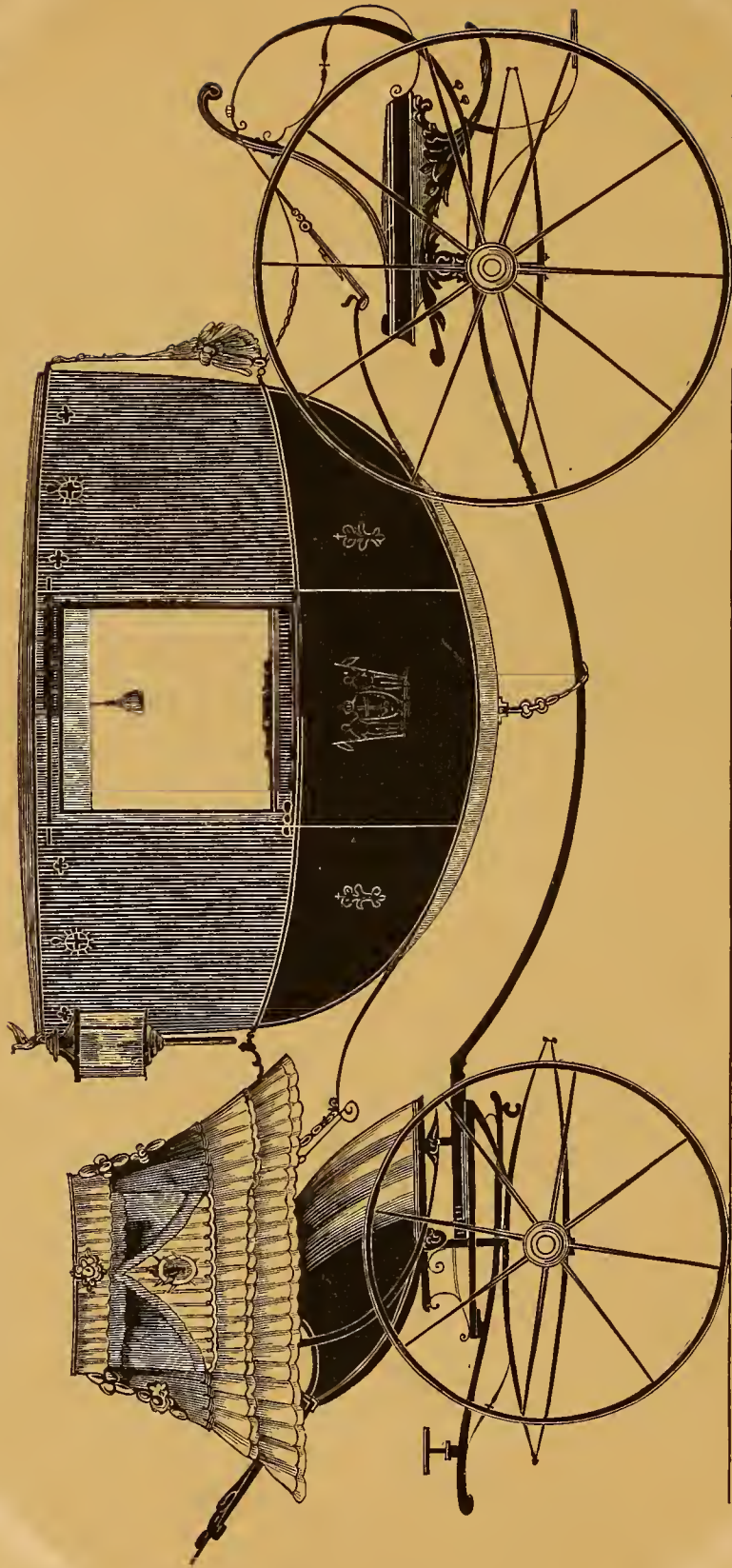

THE KING OF PRUSSIA'S DRESS COACH.— $\frac{1}{2}$  IN. SCALE.

*Engraved expressly for the New York Coach-Maker's Magazine.—Explained on page 50.*



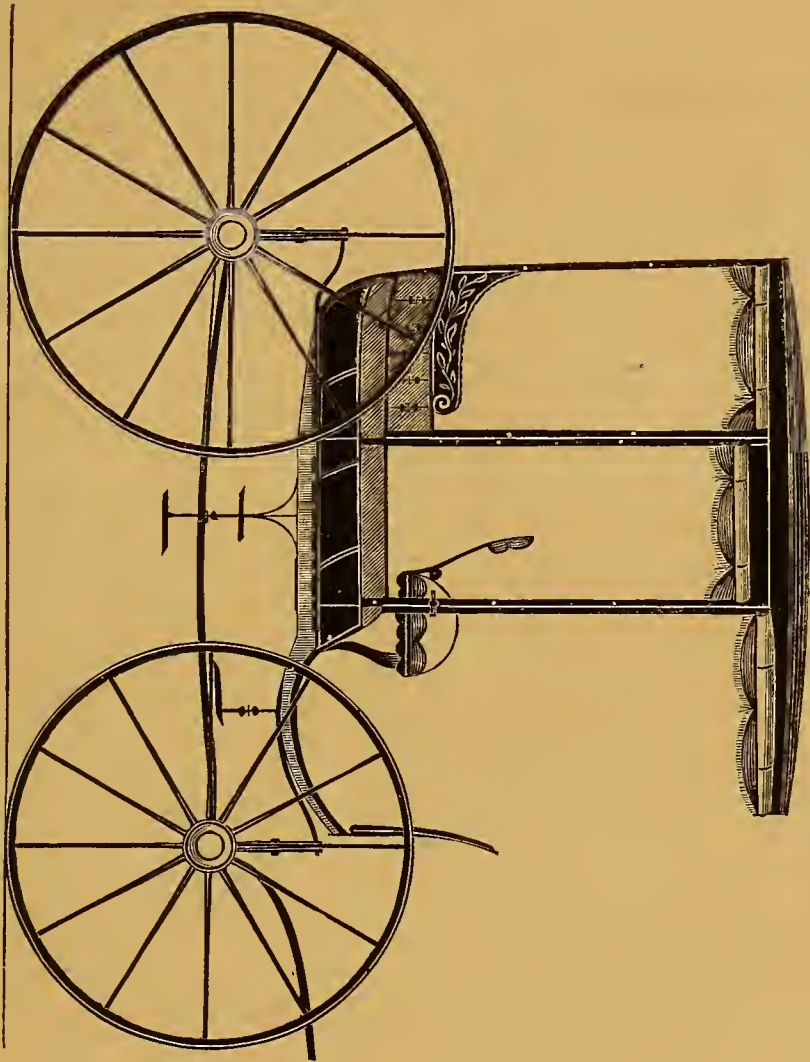

THE BOSTON JUMP-SEAT ROCKAWAY.— $\frac{1}{2}$  IN. SCALE.  
*Engraved expressly for the New York Coach-Maker's Magazine.—Explained on page 51.*





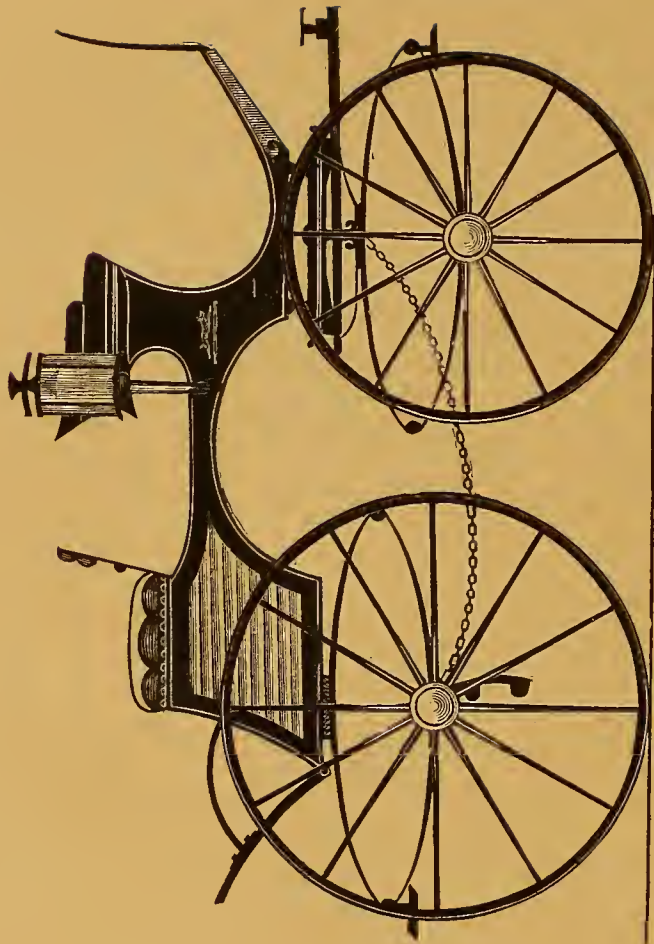

SPORTING PHÆTON.— $\frac{1}{2}$  IN. SCALE.

*Engraved expressly for the New York Coach-Maker's Magazine.—Explained on page 51.*

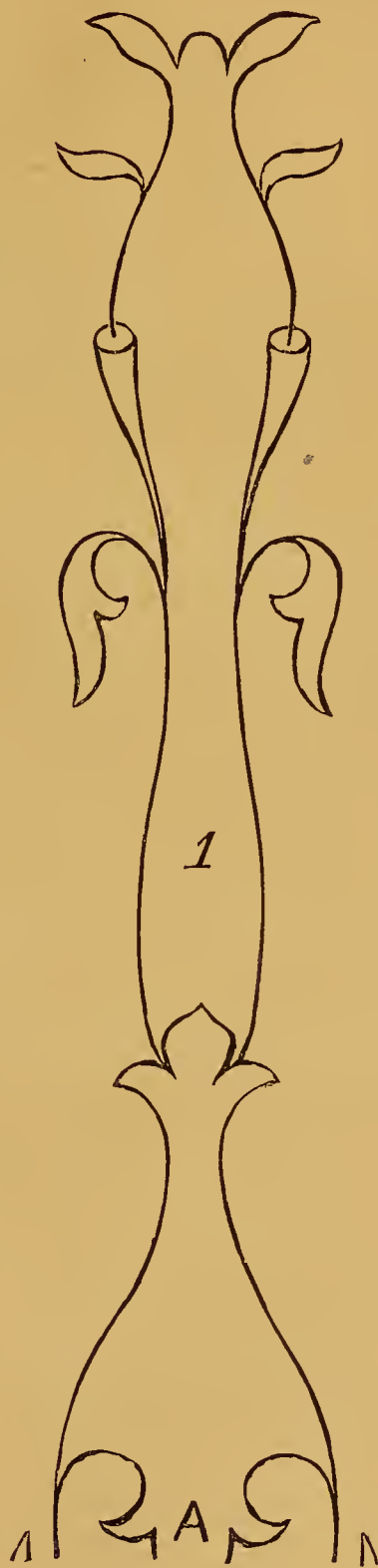





DEVOTED TO THE LITERARY, SOCIAL, AND MECHANICAL INTERESTS OF THE CRAFT.

Vol. II.

NEW YORK, AUGUST, 1859.

No. 3.

### Miscellaneous Literature.

#### COACH-MAKING HISTORICALLY CONSIDERED AND INCIDENTALLY ILLUSTRATED.

BY THE EDITOR.

##### CHAPTER XV.

Exceptions taken to the ruling of Beere-cart *vs.* Coaches—The Frenchman's disputation with an Englishman in favor of Coaches—The Thames Watermen "down" on Hackney Coaches—Sir H. Parnell on Stage-Coaches—The "Lover of his Country's" pleadings for using Horses.

IN our last chapter we found that *Messrs.* Coach & Sedan, who, like others, that trust an important case to the decision of "single-handed" Justice, were both in the same condemnation. But having made exceptions to the *ruling* of Beere-cart's court, the defendants put in a remonstrance, which was argued between a Londoner and a Parisian, who contended for the superiority of their national cities. The *proceedings* are extracted from Sir William D'Avenant's works, who says:

"The song being ended [at Rutland House], a consort [concert] of instrumental music after the French composition being heard awhile, the curtains are suddenly opened, and in the rostras appear sitting a Parisian and a Londoner, in the livery robes of the two cities, who declare concerning the preëminence of Paris and London. The Frenchman introduced the disputation in the following language: 'You of this noble citie are yet to become more noble by your candor to the plea between me, a bourgeois of Paris, and my opponent of London; being concerned in honor to lend your attention as favorably to a stranger as to your native oratour; since 'tis the greatest signe of a narrow education to permit the borders of rivers or strands of seas to separate the general consanguinity of mankinde; though the unquiet nature of man (still hoping to shake off distant power, and the incapacity of any one to sway universal empire) hath made them bounds to divide government. But already I think it necessary to cease persuading you, who will ever deserve to be my judges, and therefore mean to apply myself in admonishing him who is pleased awhile to be my adversary.' After some sharp critical remarks not pertinent to the question in dispute, he

goes back to 'the days of wheelbarrows, before those greater engines, carts, were invented, or before an umbrella of tiles was contrived to intercept the sun's rays, or that the shambles were so empty that fresh air was to be avoided lest it should sharpen the appetite,' he continues: 'I have now left your houses, I am passing through your streets; but not in a coach, for they are uneasily hung, and so narrow that I took them for sedans upon wheels. Nor it is not safe for a stranger to use them till the quarrel be decided, whether six of your nobles sitting together shall stop and give place to so many barrels of beere. Your city is the only metropolis in Europe where there is a wonderful dignity belonging to carts. Master Londoner, be not too hot against coaches; take advice from one that eats much sorrel with his broth.'

There was at this period great hostility to coaches and their use, very much heightened by the course taken by the watermen of the Thames, whose occupations on the river were interfered with. "Coaches and sedans (says one), they deserve both to be thrown into the Thames; and but for stopping the channel, I would they were; for I am sure where I was wont to have eight or ten fares in a morning, I now scarce get two the whole day!"

The horse-litter must have still been in use at this time to some extent, for Eveleyn states that he traveled in one with his sick father in 1640, from Bath to Watton, and this, says Markland, is the latest mention of the litter I can find. Probably they were then only used for invalids and sick persons.

Hackney-coaches appear to have gone on steadily multiplying in London from 1635, when the number was limited to fifty, to each of which was restricted twelve horses. In 1652 the number was increased to 200 coaches, and in 1654 to 300, and again in 1661 to 400, for each of which £5 per annum for a license was charged.

In 1672 there were but six stage-coaches in England, but even these did not escape the hostility of the pamphleteers, among whom was Sir H. Parnell. He says: "These stage-coaches make gentlemen come to London on very small occasions, which otherwise they would not do but upon urgent necessity; nay, the convenience of the passage makes their wives often come up, who, rather than come such long journeys on horseback, would stay at home. Then when they come to town, they must presently be in

the mode, get fine clothes, go to plays and treats, and by these means get such a habit of idleness and love of pleasure, as makes them uneasy ever afterwards."

In 1673 there was a pamphlet published under the title of "The Grand Concern of England Explained," which may be found reprinted in the eighth volume of the "Harleian Miscellany," by one who styles himself "A Lover of his Country." Among the public grievances which he thinks ought to be removed, is the nuisance of stage-coaches, which he pronounces to be "one of the greatest mischiefs that have happened of late years to the Kingdom—mischievous to the public, destructive to trade, and prejudicial to lands. The Lover of his Country dwells with great bitterness on the effeminacy which these vehicles engender in his Majesty's subjects. He says they become weary and listless when they ride a few miles, unwilling to get on horseback, and unable to endure frost, snow, or rain, or *to lodge in the fields*. That stage-coaches discourage the breed of horses is evident; for will any man keep a horse for himself and another for his man all the year round to ride one or two journeys, who at pleasure, when he has occasion, can slip to any place where his business lies, for two, three, or four shillings, if within twenty miles of London, and so, proportionately, into any part of England? Formerly, every man that had occasion to travel many journeys yearly, or to ride up and down, kept horses for himself or servants, and seldom travelled without one or two men; but now, since every man can have a passage into every place he is to travel unto, or to some place within a few miles thereof, they have ceased to keep horses or travel with servants. York, Chester, and Exeter stage-coaches, each of them with forty horses apiece, carry eighteen passengers a week from London to either of these places, and the same number in return from thence to London. There are also other coaches which, with four horses and carrying six passengers, go daily to places within twenty or thirty miles of London, and others that go and return the same day from places within ten miles. There are stage-coaches that go to almost every town within twenty or twenty-five miles of London, wherein passengers are carried at such low rates, that most persons in and about London, and in Middlesex, Essex, Kent, and Surrey, gentlemen, merchants, and other traders that have occasion to ride, do make use of, who, before these coaches did set up, kept a horse of their own, but now have given over keeping the same; so that by computation, there are not so many horses by ten thousand kept now in these parts as there were before stages were set up."

The "Lover of his Country" in the same strain goes on to say, that before coaches were set up, travellers rode on horseback, and men had boots, spurs, saddles, bridles, saddle-cloths, and good riding-suits, coats and cloaks, stockings and hats, whereby the wool and leather of the kingdom were consumed. Besides, most gentlemen, before they travelled in coaches, used to ride with swords, belts, pistols, holsters, portmanteaus, and hat-cases, which in these coaches they have little or no occasion for. For when they rode on horseback they rode in one suit, and carried another to wear when they came to their journey's end, or lay by the way; but in coaches they ride in a silk suit, with an Indian gown, with a sash, silk stockings, and the beaver hats men ride in, and carry no other with them. This is because they escape the wet and dirt, which on horseback they cannot avoid; whereas in two or three journeys on horseback their clothes and hats were wont to be spoiled: which done, they were forced to have new very often, and that increased the consumption and manu-

facture. If they were women that travelled, they used to have safeguards and hoods, side-saddles and pillions, with strappings, saddle, or pillion-cloths, which for the most part were laced and embroidered: to the making of which there went many several trades now ruined. The "Lover of his Country" continues his singular argument by stating that clothes and other property was more liable to be lost in travelling on horseback than by the coach system, and that how much this circumstance went to encourage trade need not be told. But we are compelled by want of space to defer the pursuit of this subject, until our next issue.

For the New York Coach-Maker's Magazine.

## THE AUTOBIOGRAPHY OF CALEB SNUG, OF SNUGTOWN, CARRIAGE-MAKER.

REVISED BY THE EDITOR.

### CHAPTER II.

A philosophical digression—The writer leaves his paternal roof—Tears shed on that occasion—Arrival at Sawgetup—Introductory conversation—Stone-fence carriage-making—Dinner-bolting at Flatt's Hall—The junior boys and shop-mates introduced to the reader—Miss Flatt marries Mr. Towner—The "old woman" of Flatt's Hall—Caleb takes a lesson at making wedges—Paying "the initiation footing."

No TRUTH is more evident than the one, that most people are dissatisfied with their different occupations. Of course there are a few exceptions to this rule. Why this is so, may not be satisfactorily explained, but probably the chief reason may be found in the fact that every branch of business engaging the attention of mankind, has some and peculiar difficulties, which are best known only to those who are engaged therein, and which leads them to think that no other is beset by so many trials. Another reason undoubtedly is, that occupations are selected for us, as in my case, in an arbitrary way, or in compliance with the whims or tastes of indiscreet relatives, or nominal friends. These unfit selectors choose a trade for their children or wards, for which their Creator never designed them. Suppose, for instance, the boy would, from his own choice, follow some mercantile profession, but through the influence of his parents he is finally persuaded to go to the coach-making business, and in nine cases in ten he never will succeed in it. That intuitive talent, necessary to give him a taste for practising with the saw and shoving the jack-plane, is deficient, and the consequence is, the boy drags through an apprenticeship of four or five years, neither pleasant to himself nor profitable to his employer. It naturally follows, as day succeeds night, that he never will pursue—as in order to succeed, all business requires—with energy and steady aim his *unnatural* business. The fact is, he is out of his element, and his tastes and business are just as inconsistent as would be the nature of a lamb in the body of a dog, and as unfitted to each other as would be the wing of a bird to a domesticated cat. Nature designed the boy for a particular station in her great laboratory; man has persuaded him to engage in another business without her proper consultation. Do you wonder, then, when perplexities and discouragements follow his footsteps all through his future life? I am not ambitious of being thought a fatalist, but I do verily believe, that every member of the great family of mankind has been specially created for the express purpose of filling some particular station in some particular business, and it is for the interests of friends as much as it is for the pleasure of the individual, that a young



man should, in most instances, be left to choose a profession uninfluenced by others' tastes or predilections, because he is himself the most deeply affected by that choice. This, alas! is too often found to be the case, when too late to repair the mischief; the unfortunate victim has grown weary and dissatisfied with his employment, and as a consequence quarrels with its difficulties, until in utter despair he sinks under an accumulated load of poverty and want. This dark picture, however, is not always realized, and fortunately in my case, after sailing near Scylla, I have not been entirely shipwrecked upon Charybdis.

Resuming the thread of my narrative, I would state that, having the prospect before me, of at least spending five years at a trade, my considerate and indulgent father allowed a week of relaxation from toil, that I might in some degree fortify my mind against future contingencies, and allay in innocent amusements my latent fatigues at farm-work.

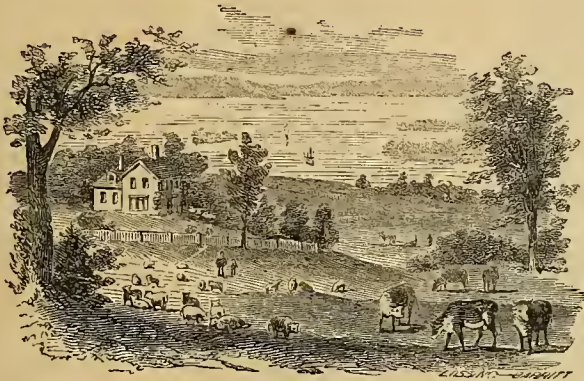

RESIDENCE OF THE SNUG FAMILY.

The morning sun shone bright and beautiful, the zephyrs were soft and invigorating, as on Monday morning, the 17th of April, 18—, after breakfast, I left my paternal home, bidding adieu, as I then supposed, forever, to agricultural pursuits. That period of my life stands out as the foreground to a picture, behind which is painted every thing that is lovely. Following that day's transaction came the homely and truthful conviction, that,

“Be it ever so humble, there is no place like home.”

As I crossed the fields from Snugtown in the direction of Sawgetup, the prayers of a fond father and the best wishes of a doting mother followed their departing son, my brother Cornelius promising to visit me the next week. My two sisters could not rest satisfied with a door-yard farewell, but they must needs gently trip along by my side as saunteringly I moved away, smiling upon and endeavoring to encourage by their company a tear-blind brother, who, could they have imagined him about to become exiled from them for a lifetime, could scarcely have shown more interest in his welfare. But the parting time must surely come. With a “Good-by, dear brother,” twice repeated, amid sighs and tears, these angelic sisters turned towards their home, casting anxious looks towards me. I was, however, very soon lost to their view by the forests which nearly covered the *two miles* intervening between Snugtown and Sawgetup.

As I proceeded along, perched upon the highest branch

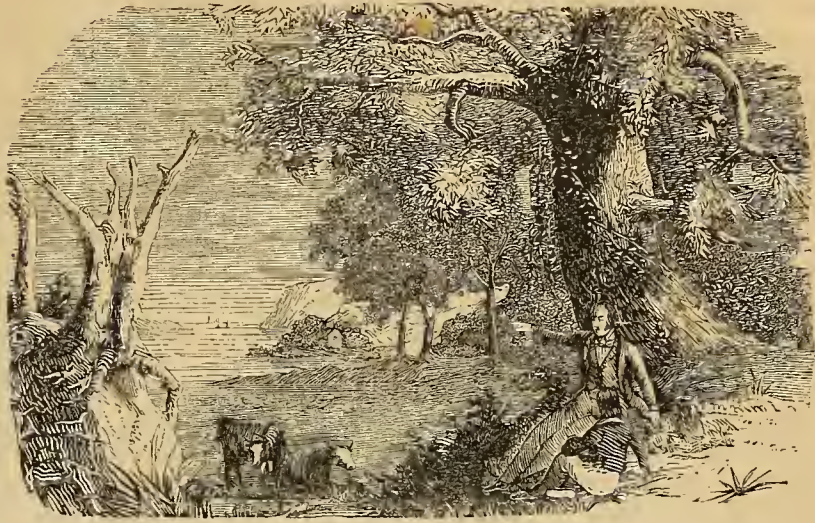

A SKETCH ON THE BORDERS OF THE SNUGTOWN FORESTS.

of an alder hedge, sat a red-winged blackbird—his early appearance presaging the return of summer—who, with distended throat, and voice of the sweetest melody, seemed to be saying, as if intended expressly for me: “A good boy be! A good boy be! Ca-la-ee!” Seemingly, so many kind attentions from all sides would have been sufficient to have obliterated all thought of “type-sticking” from the mind, were it not that nature is stronger than art, or the persuasion of friends.

Having arrived in Sawgetup and introduced myself to the members of the shop, the senior partner thus addressed me: “Well, Caleb, you have come with us to learn the carriage-maker's trade, ha?”

*Caleb.* Yes, sir, I have.

*Mr. Flatt.* You will find it a *pretty hard* business.

*C.* I don't know about that; perhaps so.

*Mr. F.* A little different from farming, I think.

*C.* I suppose so, sir.

*Mr. F.* Did you ever do any thing at making stone-fence?

*C.* Well, sir, I have done a little of it.

*Mr. F.* Caleb, come along with me. I have a *little job* down by the river, where the late frosts have thrown the fences down in some places, around my two-acre lot, and they need repairs.

*C.* [Mentally.] I had enough of *that* “fun” at home—I came here, I thought, to learn a trade.

*Mr. F.* Caleb, are you fond of making stone-fence?

*C.* [Despondingly.] Well, sir, I cannot say that I am.

*Mr. F.* It is a *good deal* like work, an't it?

*C.* Yes, sir, I used to think so when on the farm.

*Mr. F.* Well, *we* don't have much of it to do here, at any rate.

*C.* [Somewhat encouraged and mentally.] I hope not.

So, for the first lesson in *carriage-making*, I was put to mending the stone fence surrounding Mr. Flatt's “two-acre lot!”—a practice too often resorted to by bosses in this country, and which ought to be frowned down by every intelligent and right-principled business man.

This business occupied the time until twelve o'clock, when the dinner-hour came around. At the dinner-table, I found a number of “the boys,” varying in their ages from seventeen to nearly twenty-one years. The one sitting im-

mediately by my side appeared to be greatly pleased, as undoubtedly he had great reason to be; for my coming had been the occasion of his promotion. *He* was no longer the "youngest apprentice;" the cow and horse, the pig and wood-pile no longer claimed *his* attention. This, then, was a day of jubilee with him, for his initiatory year of "chores" had expired.

To one so little accustomed to seeing strangers, especially of the class usually found in large manufactories, my sensations—had the food provided us been of the most inviting description—were such as to materially lessen my appetite, and the death-like silence maintained in Boss Flatt's presence at the dinner-table did not in any degree improve it. Dinner over, which, as I afterwards found, rarely if ever occupied more than fifteen minutes, every man and boy seized his hat so hastily, that any one a stranger like myself, might readily suppose that each workman's life was staked upon the 2:40 speed with which he returned to his work-bench. At that time the ten-hour system had not been adopted, and it was the general practice, at least in the country towns, to *cheat* the apprentice out of four hours' time each day, thus getting from the boy sixteen hours of daily labor.

Since I shall very frequently find occasion to refer to my fellow-apprentices, perhaps it would be as well to introduce them to the reader at this point. The oldest, who had been some four years at his trade, was named William Trotter; the next, David Bullfinch; after him, James Mortimer, Abner Motte, and the youngest, Colin Conelin; the youngster who, by my coming to take the youngest apprentice's place, had just been promoted. These, with a single exception, all boarded with Boss Flatt, as did also the junior "boss" and his young wife, who was the only daughter of "old Boss" Flatt. Mr. Towner had formerly been an apprentice at this coach-manufactory, but having recently become of age, had just won the heart and hand of his boss's daughter. Miss Flatt's mental qualifications were expressed in her name; she was *flat* indeed; in fact, the boys *allowed* "she did not know enough to go into the house when it rained." Mr. Towner's sympathies were evidently in union with those of the apprentices, he having been an apprentice with many of my shepmates. Mrs. Flatt, I soon discovered, was just such a woman as I had often heard of, but never before seen; she was what the sailor denominated his termagant wife, and had the reputation of being a *tar-tar*. Do-the-boy's Hall, in Dickens' work, was a desirable home, in comparison with Flatt's Hall, under the management of such a mistress. But I am anticipating matters, and will now resume the thread of my history.

After dinner (my fellow-apprentices ironically always called the food furnished them, *grub*) I was sent back to the "two-acre lot," to finish the work of fence-repairing. This done, about four o'clock P.M., in order to "rest me a little," Mr. Flatt showed me about the premises—the repository, a fine building erected as a store-house for finished carriages, and the smithshop, both standing separate—as did also the trimming and harness-shops, together with the wood and paint-shop. It will be understood that the Sawgetup Carriage Manufactory comprised four large buildings, extending over more than one acre of ground, located on the bank of a river, navigable for large vessels, and I am stating the simple truth, in mentioning, that the toil of many days has often been relieved by the gambols of the finny tribe, in its pellucid waters, visible from my

work-bench. As some two hours still remained, I was late in the afternoon introduced into the wood-shop, and there set to making wedges, which is about the first lesson imposed upon all who undertake to practise at this trade. Soon an old and superannuated drawing-knife was found, and handed me, and at it I went. Mr. Flatt had scarcely passed the outer door, leading into the street, before I was called upon to "pay my footing." This was a period when abstinence from strong drink was little practised; yet, to my unsophisticated mind, it was a mystery; but a little explanation from a friendly person, working at the next bench, led me to conclude that the better way for me to get along would be "to send out." Having treated all hands—paid my footing—I was thereby duly installed as one of the craft. It is satisfactory to know that, at the present day, "the custom is more honored in the breach than in the observance."

---

### MAKE YOUR MARK.

BY DAVID BARKER.

In the quarries should you toil,  
     Make your mark;  
 Do you delve upon the soil,  
     Make your mark.  
 In whatever path you go,  
     In whatever place you stand,  
 Moving swift or moving slow,  
     With a firm and honest hand,  
     Make your mark.

Should opponents hedge your way,  
     Make your mark;  
 Work by night or work by day,  
     Make your mark.  
 Struggle manfully and well,  
     Let no obstacles oppose;  
 None, right shielded, ever fell  
     By the weapons of his foes—  
     Make your mark.

What though born a peasant's son,  
     Make your mark;  
 Good by poor men can be done,  
     Make your mark.  
 Peasants' garbs may warm the cold,  
     Peasants' words may calm a fear—  
 Better far than hoarding gold  
     Is the drying of a tear—  
     Make your mark.

Life is fleeting as a shade,  
     Make your mark;  
 Marks of some kind *must* be made,  
     Make your mark.  
 Make it while the arm is strong,  
     In the golden hours of youth;  
 Never, never make it wrong;  
     Make it with the stamp of truth:  
     Make your mark.

---

WHEN it blows out West, it "blows." Mr. C. Durham and party, of Marion county, Iowa, were recently struck by a tornado on the plains near Fort Kearney, which smashed three wagons to atoms, whirled Mr. Durham's trunk off beyond recovery, took an ox across a creek, carried the entire company from fifty to one hundred and fifty yards, and uprooted a tree ten inches in diameter, and carried it seven miles! Fine country that for travellers!

For the New York Coach-Maker's Magazine.  
**GEOMETRY OF CARRIAGE ARCHITECTURE.**

BY A PRACTICAL COACH-MAKER.

**PART SIXTH—BODY CONSTRUCTION.**

THE accompanying diagram, No. 1, shows the frame-work of the Piccolomini Calechè given on Plate No. 25, Vol. I., of this work. You will perceive, by examining the kant-board, that this body contracts  $2\frac{1}{2}$  inches on the side measured from the back bar A to the front bar B. The object of this is to get a narrow front without making it concave, the rocker being perfectly straight. This rocker can be made in two pieces, and spliced at C. Some would prefer making it in three pieces, but when there is a good sound plank used, two pieces are all-sufficient, as it saves work in splicing more than will pay for the cutting up of the plank. The inside line of the rocker ranges with the inside of the bottom-side and front-pillar, to which it must be well secured with No. 20 x 3 inch screws, about 5 inches apart.

As the strength or stiffness of the body depends on how well it is ironed, it will require two  $\frac{3}{4}$  x  $\frac{3}{8}$  iron for rocker irons. It will be well to let the rocker irons turn on the back bar about 8 inches, and take three screws. It should run forward to the bracket, maintaining its width and thickness throughout. Great care should be taken in drilling the rocker plates, and the screws should fit in the holes snug. If they do not, the body will be liable to spring. The proper size screw for such plates is No. 20, which should be as long as the thickness of the rocker will admit. The rocker may be about  $1\frac{3}{4}$  inches thick; consequently it will take 2-inch screws. Whenever you can run a long screw through the rocker into the bottom side, it would be advisable to do so. The screws in the irons may be about  $2\frac{1}{2}$  inches apart, and the plates should always be bedded in white lead mixed with boiled oil.—Some body-makers have an idea that rocker irons must be bolted on, but that is a great mistake, as I will endeavor to show. Now, the thickness of timber varies from 2 inches and upwards. In screwing up the nut on the bolt, the timber will become compressed between the bolt-head and the iron—and there is no body timber but what you can draw the bolt-head almost through, if the screw is good, the timber being compressed in that state when fresh—as all timber has a moisture less

FRAMEWORK OF THE PICCOLOMINI CALECHE ON PLATE 25, VOL. I., WITH KANT-BOARD ATTACHED.

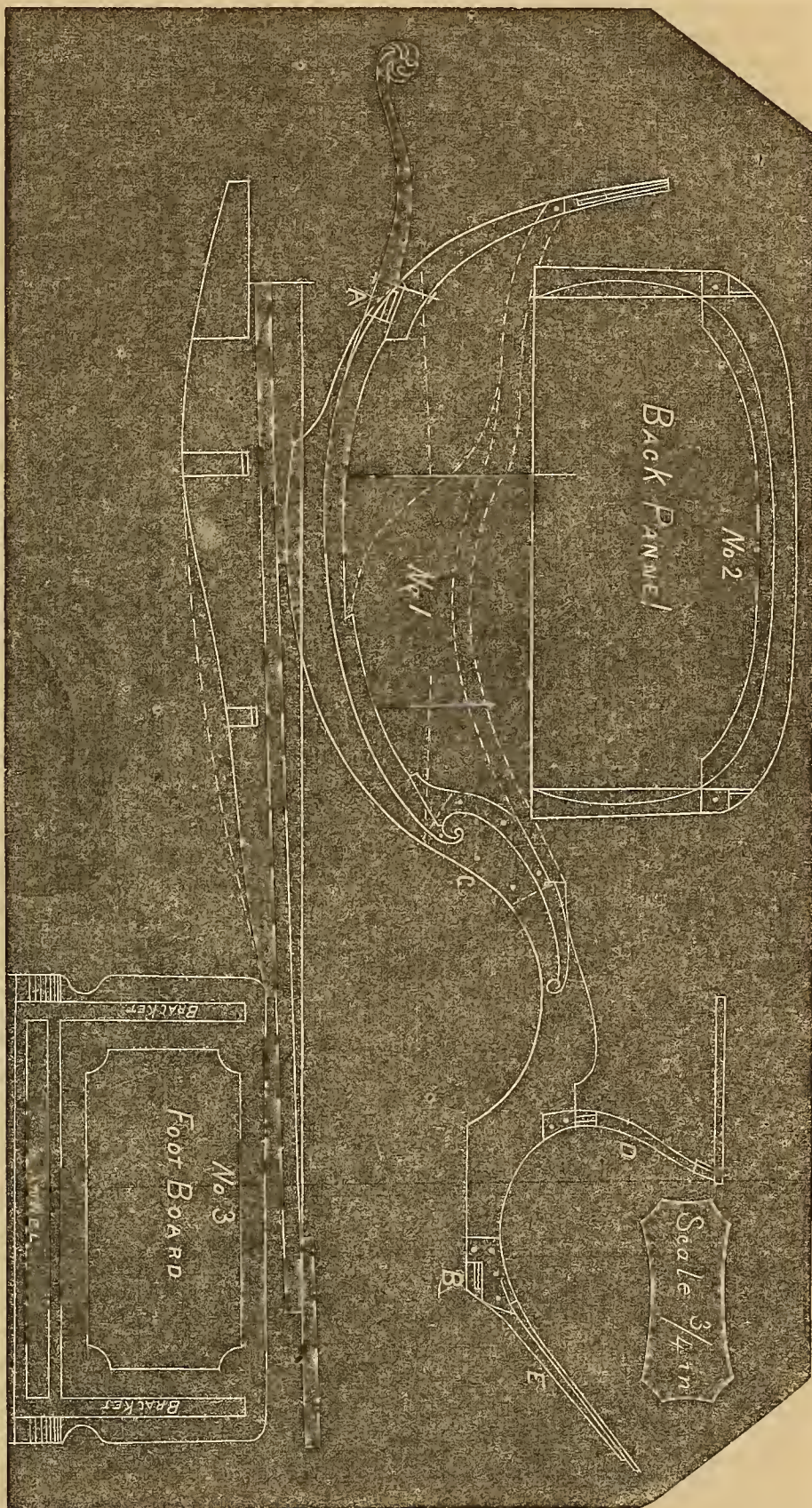

or more when it is worked up; consequently when it stands some time you will find considerable shrinkage has taken place, which can be proved by trying if you cannot get three or four turns on the nut. It may be necessary sometimes to put a bolt in where there are splices, which we shall have occasion to refer to hereafter; but when such is the case, the nuts should be tightened up before the trimmer covers them over. Now, in putting plates on with screws, there is nothing to shrink between

the screw-head and the timber. We write this from experience, having tested it thoroughly to our satisfaction with two bodies, one with irons bolted on, the other with them screwed on. The latter was by far the stiffest body. The bottom irons that run under the brakes, should run under the bottom-side also, and take a bolt and two screws past the front-door pillar. Particular care should be taken in making your calculations for all the bolt-holes for the steps, springs, &c.

In securing the back pillar there should be run a  $\frac{3}{8}$ -inch bolt through the pillar, bottom-side, brake, and bottom iron, as near the shoulder as possible. This will keep every thing all right. The front pillar can be secured with screws to the bottom-side, one at the foot inside and one underneath the bottom-side in front. Both back and front pillars must have a dub tenon, no matter how short; it will keep them in their place. The back pillar is better framed in square. We refer you to the square rule in the first volume for further remarks.

The heel brackets, D, should be halved on the inside of the rocker, along with a tenon to make it secure. The foot brackets, E, are screwed on the inside of the rocker, as represented in the diagram. There should be an iron about  $1\frac{1}{4}$  by 3-16 inches, nicely chamfered, screwed on the top of the foot-board, to continue along in front, to take the carriage bolts, extending up a little way on the heel-brackets.

Diagram No. 2 shows the most approved shape for back panels, and the mode of construction. The regular sweep represents the moulding.

Diagram No. 3 shows the manner of finishing the front of the foot-board. The centre panel is formed by nailing on small switch moulding of any desired shape. About two inches above the front bar, B, you will have to frame in a rail for the foot-board to be screwed to. Between those rails there is a panel, as may be seen in the diagram. This same job will be further explained in the next number.

(To be continued.)

### THE EQUIPAGES OF NEW YORK.

THERE are plenty of evidences of the fact, which nobody disputes, that New York is getting rich rapidly, and one of the most striking of these evidences is the surprising number of elegant equipages seen in the streets. Time was, say a quarter of a century ago, when one might count the private establishments of New York by dozens. The Van Rensselaers, the Stauntons, the Schermerhorns, the Livingstons, the Stuyvesants, and other rich old Knickerbockers, of course kept their carriages—vehicles of a somewhat lumbering order, with neat family crests sometimes emblazoned on the panels, drawn by the staidest of steeds, and driven by the most respectably conservative of coachmen; but the "oldest inhabitant" could at once give you the name and antecedents of the owner of every private carriage he met. The great world of New York still rode in public conveyances, or footed it, because the great world of New York still had its fortune to make; but now, the great world of New York having made its fortune, every body keeps his carriage. That is to say, whoever fails to keep his carriage is a "nobody," which amounts to exactly the same thing. When "calls" are making on some one of the great leaders and ornaments of the fashionable world

who happen to visit the metropolis—like Lady Napier or Miss Harriet Lane—the streets are lined with fine private carriages for dozens of blocks; and on any fine afternoon scores of carriages with liveried drivers and footmen are seen standing in front of Stewart's and other fashionable houses on Broadway, while the wives and daughters of the owners are spending their money within.

It has been estimated that the number of private carriages maintained by New Yorkers in this year of grace 1859, is not less than from 15,000 to 20,000, without including the great swarm of light, fancy vehicles driven by "fast" men on the Bloomingdale road in fine weather, or crowding the sheds of "Luff" and "Dubois," on Harlem lane, of a Sunday. The styles of carriages in use are as multifarious as the tastes of those who own and maintain them.

The close carriage, or "close quarter" coach, is considered the richest and most respectable of private carriages—or, as one manufacturer styles it, "the king of carriages." Whoever keeps and rides in one of these, is indisputably "stylish." They are most commonly in use, costing from \$1000 to \$1500, and in rare instances double these sums.

The next in order of popular favor is the caleche, which is a close carriage in winter, and, by means of removing the top, an elegant open carriage in summer, thus avoiding the necessity for keeping more than one vehicle for all seasons. On this account it is a great favorite with those who are limited for stable room. Cost from \$900 to \$1000.

Next comes the coupé, of French origin, but rapidly gaining favor in this country. It is made of various sizes, from the large hammer-cloth coupé or chariot, costing about \$1200, to the one horse coupé, worth \$700. The one-horse coupé is already quite common in our streets, and is evidently very convenient. The larger size will probably be a favorite vehicle for driving in the new Central Park, as it is convenient both for seeing and being seen.

The barouche, an exclusively open carriage, is next in order, and is very popular with those who are able to keep several carriages. They are made large and luxuriant, as lounging carriages, and seem to be all but indispensable in the present style of ladies' dresses. Plenty of these carriages will undoubtedly be seen in the Central Park drives. Cost, \$600 to \$800.

The phaeton, a smaller and less pretentious vehicle, is so contrived that the gentleman may drive himself, seating his servant behind like a footman, or, when he feels indolent, by shifting the seats, he may place his servant in front, like other carriages. These carriages cost \$350 to \$500.

The "dog-cart," an English institution, used in that country as a fancy road or sporting-carriage, has been introduced and naturalized here as a pleasure-carriage. A nice one costs about \$400. The Germantown and Rockaway coaches are plain carriages, chiefly used in the country by those who desire the convenience of a carriage without ostentation. There are endless modifications of all these styles of carriages, and besides, a countless variety of light carriages, buggies, sulkies, &c. A single firm doing business in this city is constantly engaged in manufacturing no less than ninety-four different sorts and styles of vehicles.

The increase of the class of men who "travel on their speed" has kept pace with that of the steady goers.

Twenty-five years ago the "fast men" numbered about a score, and the driving through Broadway "four-in-hand" of "Wash" Costar or "Dandy" Marx was an event to be talked about for a month; now an ordinary smash-up is an every-day hum-drum affair; and the only way to get up a genuine sensation is to run down half a dozen pedestrians, or, like a certain well-known manufacturer of sewing-machines, to sport a dashing "unicorn team" of five horses—three abreast and two leaders. There are several fancy gentlemen who drive "tandem" teams of three or four "in a string," or three abreast. But these things have ceased to be marvels.

In the style and elegance, too, of the more modest equipages, and the general dash of the road turn-outs, Young New-York is decidedly progressing; and if "cotton keeps up," and the "bottom don't fall out," we shall, in a few years, rival the establishments of the capitals of the Old World. Indeed, some of our latest efforts would probably astonish the *habitués* of Hyde Park, the Champs Elysées, or the Casino, could we give them an airing some fine day on those celebrated drives. The barouche, with "unicorn team" and a pair on the lead, above referred to, got up as they are "without regard to cost," or what "Mrs. Grundy" will say, would certainly open the eyes of "the rest of mankind" to the fact that we are a go-ahead people.

In the matter of expense—a very trifling matter, to be sure—we are fast approaching the European standard. Extra fine coach-horses are, we believe, even more expensive here than in Europe. One of our fast commodores, who doesn't do all his yachting by water, drives a pair of horses capable of going "down among the thirties," for which he paid, we are told, the snug little sum of \$8000. Some of the private stables and coach-houses in New York are curiosities worthy of notice. Not half the poor people in the city are as well fed and cared for as the horses of our rich nabobs. On the Fifth avenue and adjacent streets are stables built of brick and freestone, with much architectural display, lighted with gas and supplied with Croton water, with large and roomy stalls, and in some cases the lofts overhead occupied as sleeping-rooms for the family servants. Our reporter recently visited and inspected several of these stables. In one, owned by a wealthy banker, lately a foreign minister, he found about half a dozen splendid coach and saddle-horses, a beautiful Shetland pony, and a cow, besides the groom and coachman, half a dozen dogs, and some Guinea pigs. Every thing about the place was kept as neat as a pin. The horses were littered with fine hay, occupied large airy stalls, and seemed highly to appreciate their home comforts. The whole interior of the stable was handsomely painted. In the coach-house were three or four rich heavy coaches, of European manufacture, and an American phaeton. One fine carriage and four horses had already been sent to Newport, where the proprietor proposes to spend the warm weather. Another establishment, still more extensive, located in the rear of Lafayette place, contained not only stables and a coach-house handsomely fitted up, but a large and well-appointed riding-ring for horseback exercises.

We have lately been somewhat surprised on learning the extent of the carriage trade in New York. There are not far from forty firms engaged in the business, selling in the aggregate over five thousand vehicles annually. More than a third of this business is done by three firms—

Brewster & Co., John R. Lawrence & Co., and Wood Brothers. The two latter firms have large repositories on Broadway, and factories at New Haven and Bridgeport, Conn. The Messrs. Brewsters also have a repository on Broadway and an extensive manufactory on Broome street, employing two hundred hands. In this establishment every sort of vehicle is made, from the zephyr-like trotting-wagon, weighing one hundred and twenty-five pounds, to the most expensive and luxurious coach. The firm have already exported a number of their light wagons to Europe, where their extraordinary lightness, combined with durability, excites great attention. The senior Brewster, now verging on four-score years of age, was the first to open a repository in New York. He retired from business with an ample fortune about forty years ago. Lawrence & Co.'s is one of the oldest carriage-manufacturing firms in the city. They also export numbers of their light vehicles, sending to Europe annually \$4000 or \$5000 worth of light earriages, phaetons, &c., and filling a great many orders from South America, the British West Indies, and even Australia.

The American coach weighs about thirty-five per cent. less, and costs about fifty per cent. less, than a coach of the same pretensions made in France or England. The European coach is, however, more elaborately finished and mounted.

The harnesses got up here are considered superior to those of Europe. The principal makers in the city are Gibson, Trainor, Lowdon, and Duncombe. The ordinary price for an elegant set of coach harness, with embossed arms, is \$300, and for a fine single trotting-harness, about \$75.

There are still a few old families who drive coaches made thirty years ago, retaining their drab liveries and blue hammer-cloths. We have in mind one instance of a coachman who has driven the same coach for twenty-eight years.

The promise of a finished drive in our new Central Park at an early day—the Commissioners expect to open a drive by early autumn at farthest—is giving a new impetus to the carriage trade, and is likely to work an entire revolution in the style of vehicles. Now, in consequence of that peculiar New York institution, the dust, ladies are too commonly cooped up in close carriages; but as soon as they can drive where there are good police regulations and a freedom from that annoyance, carriages suitable for full dress will be in requisition, and strangers visiting the city will have an opportunity to see all its gayety and loveliness displayed to the best advantage.

There has been of late years a growing taste for heraldic display upon the coach-panels of our aristocracy, and a heraldry office, located in the upper part of Broadway, engaged in getting up coats-of-arms and crests, is well supported. But gentlemen do not always consult the heraldry office, and consequently ludicrous blunders are often made; as for instance, the "bar sinister," to be seen almost every where, is used apparently in utter ignorance of its significance of illegitimacy. We suggest to the indefatigable Browne, that if he will read up in the pleasant study of heraldry, and impart of his knowledge of arms to the fashionable world, of which he is so distinguished an ornament, he will find it a paying occupation. Browne had ordered his carriage of the manufacturer, and it had been sent home. But it occurred to Browne that he, too, must have a coat of arms. So Browne went to the heraldry

office and bought a sketch. Then he went to his coach-maker and asked him if he could send a painter to put it on the panel. Said he: "It is pretty large, and I have a mind to have it above, instead of on the panel, where it is likely to get muddied by the wheels." "What is it like?" said the manufacturer. "Well, the upper part is a human head, with a wreath, and the bottom, about three inches square, is made up of various colors." The painter was sent accordingly, and was in the act of decorating Browne's carriage with many-hued dragons and other impossible monsters of heraldry, when a neighbor, who had known Browne in the molasses and codfish trade, happened along, and by dint of urgent remonstrance dissuaded Brown from making an ass of himself. The brilliant coat-of-arms was removed, and a small, neat ornamental design took its place.—*N. Y. Herald.*

## The Home Circle.

For the New York Coach-Maker's Magazine.

### LOVE AND MONEY.

(Concluded from page 30.)

#### CHAPTER V.

"And looked from that lone post to death  
In still, yet brave despair."—HEMANS.

"FAINT heart never won fair lady—nor her fortune either," chuckled Gustavus A. Flash to himself as he rolled smoothly along the Newport pike towards Ridge Farm, in a handsome buggy. No horse for him this time; in fact, he didn't know that he should ever ride on horseback again, it was too fatiguing. Gussy was in fine spirits, and he whipped his horse now and then, and all the little pigs that came in his way, "just for amusement," as he pleasantly observed to himself. Now it so happened that Gussy had a habit of talking to his amiable self when particularly pleased or interested; added to this, he had taken the pains to consult the register at A—, to know the exact amount of Miss H.'s property, which fact, by some untoward event, coupled with a few unlucky remarks, had come to the Dr.'s knowledge. It so happened, furthermore, that on this eventful morning Dr. H. had gone to A— to court, and taken his men, as they were required for witnesses in some law-suit. Emily had gone down to the pike to sketch a group of trees overshadowing it in one corner of the orchard, and while there she observed a playful colt work open the fastening of the gate, and pass out to the pike, speedily followed by all the cattle. It instantly occurred to Emily that there were no men on the place; and fearing the cattle would stray away, she determined to turn them in again herself, and secure the gate. But this was easier said than done, as Emily found to her cost after she had chased them up and down considerably, and any thing but romantically. The cattle seemed to be willing to go any where but in at the gate, but after considerable exertion, in which her hair declared for independence, and her face glowed, to use her own graphic expression, "like a full-blown peony," she at length got them collected together in a cloud of dust on the pike in front of the gate, when up drove Gustavus Adolphus Flash, in state. With a little care in driving, a very little, just a curve round the cattle, he might have aided the supposed dairy-maid effectually: but he was not at all pleased with the dusting he was getting; besides he was facetious, and thought it would

be rare fun to see the woman's vexation at having the cattle all scampering again; accordingly, he dashed directly through the midst of them, scattering them in every direction, calling out as he did so:

"An' is it you or the cattle, Biddy dear, that's so stupid ye can't get them firminst the gate?"

"Both," retorted Emily, her momentary vexation vanishing as the idea of her comical situation flashed over her, and too fond of a joke at all times to let the present opportunity slip: "I took you for a gentleman, you took me for Biddy, an' sure and it was neither of us."

Slightly discomfited, but too consequential to be more than temporarily ruffled by so insignificant a person, Gussy drove on to Ridge Cottage, and by the time the maid appeared in answer to his summons, his face wore its blandest expression. Almost any other man would have thought the Fates against him when informed the Doctor was not in, would not probably be back till evening, and it not yet quite noon; but Gussy, as before intimated, had firmness largely developed, not to mention self-esteem, which stood up like a door-knob on his cone-like cranium; "though not a bad head either," as he often confidentially remarked to his reflection in the glass, only *it was pushed a little too far back.* Not to be outdone on this present occasion, he decided on a bold stroke, and inquired for Miss Howard. The servant was a new-comer at Ridge Cottage, and as Emily superintended her brother's bachelor establishment, and was called Miss Howard altogether, and her guest simply Miss Augusta, by the domestics, she answered unhesitatingly that Miss Howard had gone down the lane yonder to the woods, whither Gussy determined to follow her. He had not gone far into the wood, as directed, before he saw Emily returning down a slope which had been terraced. Gussy stood at the foot of the terrace, which was four or five feet steep, and spoke up to the lady advancing.

"Miss Howard, I presume," and Gussy lifted his hat high above his head, and bowed most profoundly.

"Yes," replied the lady.

"I called to see my friend Dr. Howard."

"I regret to say that he has gone to A—, and will not return till towards evening; will you remain till he comes, or is there any message I can deliver for you?"

"There is, but in the mean time let me assist you down the terrae."

From the moment Emily spoke, Gussy had felt extremely uncomfortable. There was something in the figure, dress, and voice that irresistibly recalled the dairy-maid of the pike—could it be possible that—pshaw! it was too absurd, and he extended his arms gracefully to lift the lady down. Was it nervousness, or the mischief lurking in the bright brown eyes bent down upon him, or insecure footing, that made him so unsteady? Certain it is, that just as he lifted the lady off, down he came full length into the muddy little brook below, and the lady with him. She bounded to her feet in an instant, laughing immoderately. Gussy followed her example more slowly, laughing too, but rather ruefully, for his splendid new light suit was decidedly beyond "heart-smashing" service now.

"We have met before, I believe, and neither encounter has been exactly what we could have wished," said the laughing Emily, glancing at Gussy, who stood there so crest-fallen, and in so pitiable a plight, that her kind and feeling nature instantly strove to repress all tendency to mirth. "But suppose we adjourn to the house as fast as possible,

and see what can be done to remedy this direful catastrophe." We need scarcely say that neither Gussy nor Emily were very communicative during their walk back to the cottage. In fact, Emily was too full of repressed laughter to be quite at her ease, and Gussy, for once in his life, was too mortified and too thoroughly disheartened to brave it out. When they reached the house, Gussy was shown to the Dr.'s apartment, and provided with a suit of the Dr.'s—a world too long and too wide; for Gussy, like many another great man, was small of stature, though, as he often confidently asserted to himself, "his little body held a mighty mind." Dr. H. returned earlier than usual, bringing Temperly, nothing loth, this time, along with him. During their homeward drive, the Dr., from some remark or other, learned the mistake under which Temperly was laboring with regard to his sister, and, being somewhat eccentric, he determined he would leave it to Emily to correct the mistake. On reaching home, and learning, in a confidential chat with Emily, something of the mishaps of the morning, over which he laughed heartily, it occurred to him that it would be a good joke to deceive Gussy also, whom he considered "fair game," by palming off Augusta as "the heiress." In order to do this, it was necessary to get both the girls' consent and cooperation, which he had some difficulty in obtaining, until he enlightened them on the object of Gussy's visit to the County Clerk's office, interspersed with a few of the least exceptionable aforesaid unlucky remarks of Gussy's, whereupon the girls agreed, on condition that it should be for this one evening only.

Gussy, all this while, was in durance vile in the Dr.'s chamber, for he prided himself too much on his personal appearance to be willing to meet Miss Howard, or any other lady, in his present trim. Meantime he was racking his brain to invent some plausible excuse to redeem his credit with Miss Howard, when the servant entered with his own well-cleaned suit, in which he quickly incased himself; and after the Dr. conducted him back to the parlor, and introduced Augusta simply as Miss Howard, and Emily as his housekeeper, with the air of one altogether unconscious of any previous meeting, "Richard was himself again." How he congratulated himself that the nymph of the woods was not Miss Howard at all. The servant, in Hibernian fashion, had made a mistake. What a lucky blunder for him; and this, after all, was only the housekeeper. He could see through it at once; no wonder she was after the cattle, it was her interest to keep things in order; besides, now that he observed her, she seemed rather too attentive to Howard, rather too familiar with the Dr., for his fancy. He meant to have an eye on her proceedings—her ladyship's plans might be circumvented; yet he would put H. on his guard as soon as ever he had a right. Meantime he must "put his best foot foremost" with Miss H. How gaily he laughed and chatted with Miss Augusta, complimented her, recounted the most wonderful exploits, of which he was always the hero, never for a moment suspecting that the young lady's very evident amusement was caused by himself rather than his anecdotes. The Dr. was called away again, much to his annoyance, directly after supper, and Temperly was only too happy to have Emily almost entirely to himself, for Gussy was altogether too self-important to have another word to waste on a housekeeper. The evening passed pleasantly away, and the Dr. did not return. Towards bed-time a messenger arrived,

with a request from the Dr. that the gentlemen would remain all night, as his men would not return from A—that night, and he could not leave his patient.

Gussy was delighted. It had been his pleasure, as well as his privilege, he said, to be a champion for the ladies; in fact, according to his own assertion, substantiated by many personal anecdotes, he had perilled his life more than once in their behalf, and if need be, he was ready and willing to do so again. In truth, our friend Gussy was somewhat elated this evening by his apparent success, having arisen, as he supposed, from the depths of humiliation to the highway of fortune. He was so elated, that he could not help recounting to Temperly, after they had retired, the mistake the servant led him into, taking care, however, to conceal carefully his own misadventures, and winding up with a little good-humored raillery for the benefit of Temperly on his courtly politeness to the housekeeper. "Why," said T., "I couldn't do otherwise, if I'd been so disposed; you entirely monopolized Miss Augusta, and never once condescended to notice Miss Emily Howard."

"Howard! is that her name? True enough, I remember now she told me so in the woods."

"Certainly; she's a cousin of the H.'s."

"You don't say so! That accounts for her taking such a position here, and their treating her so well. The Dorothy at the door was not so far wrong after all. Well, she don't please me at any rate. I'm right glad she is not the heiress! I couldn't like her in any case; she has such a disagreeable laugh," and Gussy's face assumed an expression something between mortification and dislike.

"Indeed," took up Temperly warmly, "I think she is decidedly the lovelier of the two; in fact, there is no comparison. Her laugh! why, that is perfect harmony, so low, so pleasant, so heartfelt; but," said he, recollecting himself, "suppose we change the subject."

"*Chacun à son gout*," returned Gussy with a real French shrug of the shoulders, "you and I never could see alike;" and, turning over, he became absorbed in his own air-castle building, till he fell asleep.

Far in the night, after some frightful dreams, Temperly awoke with a sense of suffocation oppressing him, and, conscious of an intolerable smoke in the room, it instantly occurred to him that the house was on fire. Springing up and waking Gussy, he threw on some clothes and rushed to the door, followed closely by Gussy, who was so frightened that he clung to Temperly in utter helplessness. On opening the door, the pent-up flames burst in, bearing Temperly back, scorching him some, and the nearly naked Gussy considerably. With wonderful presence of mind, Temperly fell back behind the door, and called Gussy to help him to close it again against the terrible stream of fire. But only the instinct of self-preservation was uppermost with him. He was battering away like a lunatic at a window, which in his fright he could not open. Temperly succeeded in closing the door himself, and then flew to the window, which he unbolted at once, exclaiming: "For God's sake be quick—what has become of the women? What if the fire originated in their room! Merciful Heaven! we must save them!" But Gussy, crawling out, had let himself down by the window-shutter on the grape-bower, and so to the ground, and was now running neither himself nor Temperly knew whither. Temperly had followed him down, and rushing to the doors, he found them all fastened, and no noise as of any one stirring

within. He shook the door and shouted, but in vain; no one answered. There was no way of entering but back again by the bower and in at the windows. With desperate energy he climbed back, he scarce knew how, and in at the window of the girls' room. What a scene presented itself! There lay Augusta on the floor, insensible from fright or suffocation, and Emily bending over her, and rubbing her like one distracted.

"She is dead!" exclaimed the terrified girl, as Temperly sprang into the room; but the cool rush of air from the open window was already reviving her. "Come," said Temperly, catching Emily in his arms, "quick, for God's sake, or you're lost;" but Emily shrank back. "Save her! only save her." "I will try to save both; oh! for mercy's sake, come!" seeing she still persisted, "I will return for her immediately." But Emily would not move, and snatching up the now conscious Augusta, he bore her to the window, imploring Emily to try to follow. She did so, but on looking down from the height, and knowing her inability to climb, her heart failed her, she was afraid to venture. With incredible difficulty, Temperly succeeded in getting Augusta to the ground, and without a moment's delay started back again; but by this time his severely tried strength was failing, he could scarcely climb. When at length he reached the room, what was his horror on finding her no longer there! The door was wide open, and the red flames had filled the room. "Emily! Emily!" he called frantically, dashing through the flames and across the hall, part of which and the stairway had already fallen. He thought he heard an answer, and rushing in the direction of the sound, he found the self-sacrificing girl alone in a room, the flames curling around and above, calmly awaiting death. "I will save you yet," he cried, springing to her and drawing her towards a window; but, on opening it, it was found too high, and there was no friendly bower here, as on the opposite side. He then bore her to the door, attempting to dart through the flames with her, but was driven back. Just then part of the floor on which they were standing fell in with a tremendous crash. "Emily, my life, my love, we will perish together," he whispered despairingly. She put her arms around his neck, laid her head on his shoulder, and closed her eyes, like a weary child going to sleep—she had fainted. Staggering to the window with his precious burden, he shouted for help. He was answered. Quickly a ladder was steadied below, and soon the strong arms of Dr. H. were up-raised to receive his sister. The sudden revulsion gave Temperly new hope, new energy; and placing Emily in the Doctor's arms, he prepared to follow, while a shout, loud and prolonged, went up from below as the rescued ones appeared.

It was decided that Temperly should drive the ladies to his mother's cottage in the Dr.'s carriage, whither the Doctor was to follow them as soon as he had saved what he could of his effects from the burning building. The Doctor arrived soon after them, and it was well he did so, for he found Temperly suffering severely from the effects of his hitherto unthought-of burns. Temperly was confined to his room for several days, at the close of which, he sought Emily to ask her the most important question of his life, and it was then for the first time he learned that he had won, not so much the heiress of many a broad domain, for the treasures of earth require a just and faithful stewardship, but a good and noble woman for a life companionship—a help-meet for time and eternity.

In regard to the fire, it was supposed that the unfortu-

nate woman whom Gussy termed the "Dorothy of the door" was the cause of it, as it had evidently originated in her room. In fact, Miss Howard had seen her reading a novel in bed just before retiring. On being reproved, she begged to be allowed to read "just to the bottom of the page," promising to stop then for certain; but dearly had she paid the price of her carelessness, for only her blackened and charred remains were found among the ruins. As for Gussy, he brought himself up full standing somewhere in the neighborhood of the "Negro quarters," some of whom he sent for the neighbors, so that he was not altogether inefficient. He found it convenient, however, to send a "regret" to the modest wedding party at Temperly's cottage when invited, and he consequentially remarked to Farrenton and others some time after, that the Howards were good clever sort of people enough in their way, but rather rustic; in fact, they were not of his set—oh! he acknowledged them as acquaintances certainly, but nothing more.

Something has been rumored lately, in connection with Gussy, of pecuniary embarrassments, gambling even, and prospects of litigation; but it is said also, that there is a substantial friend quietly at work for him, who has learned from the Blessed One of Bethlehem this simple lesson: "Take heed that ye do not your alms before men to be seen of them, otherwise ye have no reward of your Father which is in heaven."

## Pen Illustrations of the Drafts.

### THE KING OF PRUSSIA'S DRESS-COACH.

*Illustrated on Plate VIII.*

A DRESS-COACH, built last winter, by Hooper & Co., of London, for his Majesty the King of Prussia, combines all the latest improvements applicable to such carriages. The iron-work is throughout arranged so that, although light, it may give its utmost strength in sustaining the weight and work. The color, carmine lake, picked out, and fine lined a rich red.

The lining is made from patterns sent from Berlin, the lace being woven in drab, with the royal crown and cypher in relief. The crown is also woven in the pattern of the silk. The roof is of a thin drab silk, plaited to a central point, and finished with a richly chased and gilt star. The spring curtains of pink silk, and the sofa back squabs, bordered with a large silk cord of pink and drab. The step-leathers are richly embossed in gold. The metal work is silver plated throughout, the buckles being richly chased. The heads of the snakes, terminating the body-loops, are gilt, and the door-handles, besides being richly chased in silver, are heightened in gold.

The silver ornaments on the upper quarters consist of the royal crowns in silver, and in the top centre of each upper quarter is the spread eagle, surrounded with the collar of the black eagle, and surmounted by the crown.

The arms on the door and end panels are surrounded by the Order of the Black Eagle, and surmounted by the royal crown, the supporters being two wild men wreathed with green foliage. On the lower quarter, the cypher, royal crown, and national motto. The standards behind, and the Salisbury boot, are of the usual pattern, but of lighter construction.—*The Carriage-Builders' Art Journal.*



For the New York Coach-maker's Magazine.

THE BOSTON JUMP-SEAT ROCKAWAY.

*Illustrated on Plate IX.*

Boston, Mass., June 15, 1859.

MR. STRATTON—*Dear Sir:* Inclosed you will find the sketch of a style of "Jump-Seat Rockaway," which you may publish in your valuable Magazine, should you deem it worthy. It is drawn to a half-inch scale. This kind of carriage is coming into great use in this part of the country. The adjustable seat is of G. & D. Cook's patent, which, I believe, has not until recently been applied to Rockaway carriages. The Messrs. Cooks have lately disposed of their right to the patent for Massachusetts, to Mr. D. H. Bayley, who liberally disposes of rights to carriage-makers, to use this invention, for a small consideration.

GEO. R. GROOT.

For the New York Coach-maker's Magazine.

SPORTING PHÆTON.

*Illustrated on Plate X.*

THIS design for a sporting phæton is English in many respects, and cannot be excelled either for convenience or lightness. The back boot can be made commodious enough for a couple of dogs; the arch being unnecessarily large, unless for lightness.

The back seat can be hinged so as to turn into the boot. Then the foot-board turns up, (and fastens with a lock,) which forms the back panel. The drag-chain and slipper are very useful on a carriage of this description, having to go through a rugged country, sometimes.

J. I.

## Sparks from the Anvil.

### THE IRON MANUFACTURE—NECESSITY OF ENCOURAGING ITS HOME PRODUCTION.

THE following sensible remarks on the manufacture of iron, and the importance of encouraging its production in the United States, we take from the columns of a cotemporary. It is from the pen of a person who appears to be well acquainted with his subject:

The consumption of iron *per capita* may be safely taken as the measure of a nation's material progress, being an article not easily converted to the purposes of luxury. In this respect, the United States and England hold the first rank, but there their similarity ends, since England, in addition to her consumption, exports annually of iron and its manufactures to the amount of \$30,000,000, while we import of the same about \$25,000,000. An advocate of free trade views this as a very desirable result. England has the iron, and we want it. Its transportation over the ocean employs a tonnage of 400,000, and the commissions, profits, and other charges, enrich our merchants. But is there no other light in which to view it? How does this immense importation affect our home production, and the collateral interests? for we must produce iron at home, and in some way foster and protect it in the very teeth of free trade. We import only one-third of what we consume, the remainder being produced at home, and should this latter supply cease, the price of iron would rise to a point that would immediately curtail consumption, crush all our industrial pursuits, and arrest our progress in every direction. It is

evident that even in the most pacific and ultra free-trade times, we cannot abandon our production of iron. But although the native producers of iron supply the larger amount, the market is exclusively controlled by the foreigner.

The English iron-masters meet in quarterly conventions, and fix for the ensuing three months the price of labor and of iron. If their own market is fully supplied and further pressure on it would be unadvisable, the surplus stock is thrown on our market, deranging it, and fatally embarrassing the American producers. This course has been pursued time and again, and the official order is frequently copied into our own papers for our special delectation. To sustain their home market, they can afford to sacrifice on what they export, and, at the same time, ruin our furnace-owners, arrest and even diminish our production, and thus prepare the way for a rise, of which they alone are able to take advantage. The English manufacturer has the advantage of capital; he has the advantage of low labor, often obtained at a price just above starvation; and especially he has the advantage of the past policy of his Government, which for a century and a half protected him from all competition, by duties rising from 10s. to £6 10s. on pig, and as high as £23 10s. (\$114.68) on wrought, while certain kinds were prohibited. The production by these means having increased from 15,000 to 1,500,000 tons, (1846,) the duties were removed, and, careless of competition, free trade declared, and we are invited to an unequal participation in its benefits. Is it selfish for the American to demand of his Government a similar policy to that which has so firmly established his English rival? A just and reasonable protection afforded him would in ten years place him beyond its need, by encouraging the investment of capital, while native industry, enterprise, and ingenuity of invention, would cheapen the processes of manufacture, and double the production. Of material there is plenty; every State possesses its millions of tons of ore, while our coal-fields underlie hundreds of thousands of acres. Thus the consumer would obtain a secure supply at a constant low price, and American iron, from its superior quality, would drive the English article out of the markets of the world.

As a branch of our national industry, the iron manufacture is especially important, the annual production being about eight hundred thousand tons, employs a capital of \$50,000,000, mostly invested in buildings, mines, &c. As labor-saving machinery can be applied to the blast furnaces, &c., to a limited extent only, manual labor enters in large proportion to the cost of iron; this percentage of labor in the cost of pig is about seventy, and in wrought iron fifty-five, and thus there is annually paid by the iron-masters of the Union \$20,000,000 in wages, which represents so much consumption of the necessaries of life, and consequently reverts to the farmer, the manufacturer, and the merchant. If, instead of pursuing the specious fallacies of free trade, and shipping his wheat and pork to England, and iron back, the farmer of Missouri, for example, encouraged these English laborers to become his immediate neighbors, making iron from the inexhaustible ores of the Iron Mountain, he would obtain Liverpool prices for his wheat and pork at his own door, besides disposing of all those vegetable products which will not bear transportation. The four hundred thousand tons of iron now obtained abroad, would then be made at home, and \$10,000,000 annually paid in wages for it, would vivify every branch of trade.

As regards the past policy of our Government in respect to the iron interest, it would appear to be framed with the express purpose of discouraging the manufacture here. The *ad valorem* system works to the entire advantage of the foreign manufacturer. When iron is high in England, and there is no necessity for him to ship abroad, our duty is high to prohibition; when iron is low in England, and he must spare his own market and crush his American rival, we invite him to it by a nominal duty. This fact is so obvious that it appears puerile to call any one's attention to it, yet it is the enacted policy of a great Government, by its very nature ostensibly opposed to injustice; it is very obvious, yet Secretary Cobb ignores it.

There is another point worthy of consideration, and that is the superiority of American to English iron. Of this fact there is no doubt. Inquire of intelligent consumers, blacksmiths and machinists, and they agree on this point. Trace the origin of iron in bursted boilers, defective anchor cables, disabled engines in our national vessels, and broken railroad bars, and in nine cases out of ten you find it English. The past summer a London paper called pointed attention to the miserable stuff being then made in Staffordshire in the shape of boiler plate for the American market. Iron to be *cheap* must be *good*, and you may invent the most scientifically perfect shape for a railroad bar and it would be worse than useless if not made of good iron. If good iron is made in England, she has uses for it, as she never sends it abroad, but that bad iron is made there, the brittle compound of clay, iron-stone, and cinder that we encourage her to send us, assures us. Yet because this stuff is low-priced, our boiler-makers, Government contractors, and railroad directors use it, at a fearful risk of human life and national disgrace.

Considering iron as an indispensable material in warfare, we can most plainly perceive the advantages of a secure and complete home supply. It is not at all improbable that we shall sooner or later be at war with some one of the Western Powers of Europe. Then, with our foreign supply cut off and the demand enhanced, iron would rise to such a point, that consumers would pay in one year a greater tax than in twelve through the operation of a reasonable tariff. A nation without a complete supply of this metal in her own resources, is never prepared to incur the consequences of war. Such a nation is vulnerable in a most vital part; and it is to be hoped that our cautious legislators will remember this amid all the "imbroglios" we are constantly getting into and out of again. One of a more serious nature may come, when treaties and diplomacy may fail, and all depend on hard knocks and harder iron.

#### OXLEY'S PATENT FORE-CARRIAGE.

This invention, admirable for the simplicity of its motion, and the beauty of its mechanical arrangement, is certainly one of the greatest improvements which have been made in carriages for many years. It accomplishes those highly desirable objects which the carriage-builders of this and other countries have so long been striving to obtain, viz.: a shortening of the lock, with a maintenance of uniform bearing. Considering the numerous plans that have been tried, wherever an advance has been made in carriage

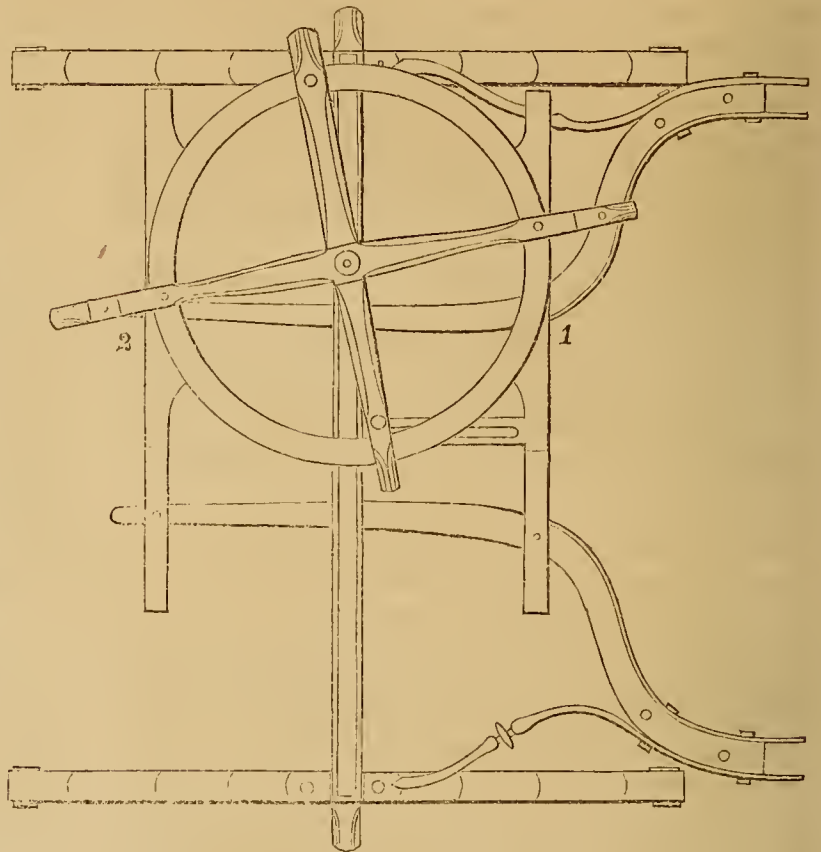

building, to produce the same results, it is singular that all but this have failed.

Mr. Buchanan, Mr. W. B. Adams, Mr. Horne, Mr. Davis, and many others, have patented their methods for this purpose; but all have had the serious defect of leaving their bearings when turning or locking, and have consequently been insufficient for the support of the pole. Another objection to Mr. Buchanan's plan is the intolerable noise it makes when in motion, a property which has obtained for it in France, where it is generally used, the popular name of the chattering wheel-plate. Noise is entirely obviated by this carriage-part; good and uniform bearing are maintained, both when the draught is straight, and also when locking or turning at right angles. It has, moreover, this advantage, that the lower plate being faced with hard wood, and the working or turning part of the top plate acting against the face of the wood, it turns easily, and, if required, the slide bar on the top of the bottom bed can be galvanized, and so protected from rust. But the result obtained by this method of construction is, that much larger front-wheels can be used without interfering with the shape of the body of the carriage, or raising it higher from the ground.

In Broughams, Park Phætons, and all carriages of a like class, when a wheel-plate twenty-two inches in diameter is used, a shortening of nine inches is gained between the fore and hind wheels, the draught being greatly lessened. This is of considerable importance, especially to medical men, and others who work their horses daily. A Brougham with this carriage part will be quite within the power of a comparatively light horse. It must be evident that this invention is of great utility, but its value is still more apparent in the country than in London, as there it is absolutely necessary that the wheels of carriages should follow in track.

Several manufacturers in London make the fore axle five

or six inches shorter than the hind axle; this plan has its supporters, but it is evident that it is a vain attempt to remedy a serious defect. Every careful observer may see that as soon as a carriage with a short front axle leaves a paved road and enters a macadamized, stiff with mud, four tracks are made instead of two, as would be the case if the wheels followed in lines; and thus the strength of the horse is put to an additional test.—*The Carriage-Builders' Art Journal.*

## Paint Room.

For the New York Coach-maker's Magazine.

### THE CRAWLING AND SHRIVELING-UP OF VARNISH.

MR. EDITOR—*Dear Sir*: I promised you, some time ago, that I would give you my experience, of twenty-five years, on the "shriveling and crawling of varnish," &c., but ill health and the pressure of business have prevented me from doing so. An inquiry in your last number, from Shelbyville, Tenn., on the blistering of varnish, prompts me to fulfill my promise. A volume might be written on the use, and abuse, of varnish; but every evil has its cure, and one would have supposed that past experience would at least have suggested a remedy. Although we live in an age of improvements—and there are many good ones—yet in some instances we have not let well enough alone, and have forsaken the old landmarks. Young America is wise, but it remains to be seen whether they are any wiser than their fathers.

"Well, Mr. Coach-painter, how do you like the varnish sent to you?"

"First-rate; I do not want any better. Look at that body; it stands out like a mirror, works well, and can't be beat. But look here, on this carriage-part, it is all shrivelled up. The same varnish—out of the same can as that on the body. Poor varnish; miserable stuff! Look! it hangs in drops under the hubs."

"Well, sir, will you answer a few questions? Is your shop as warm as it is in winter and summer?"

"No, sir. We don't keep up fires a-nights now."

"Was this carriage-part in the glass or varnish room with the body, which looks so well, as you say?"

"No; it was varnished out here, where it is not as warm."

"Who varnished this carriage-part?"

"The apprentice boy. I never varnish any carriage-parts myself."

"This varnish is laid on very heavy."

"O yes! we always put on as heavy a coat as possible on our carriage-parts. Won't it come out smooth when it is run out into the sun, or into a warm room?"

"Yes, if it don't stand too long in a cold room."

The above is almost word for word of a conversation recently had, and is not an uncommon circumstance. It speaks for itself. The proper use and abuse you see at a glance, of the same varnish. Again, you know the process, care, and number of coats of paint, ruff-stuff, color, and varnish put on the body, to fit it for the last coat of English or wearing-body varnish. You know also the number of coats of paint-color, varnish, &c., put on running-parts, which is not more than one-third that put on a body, and for this deficiency, one single coat of all varnish piled on a body in a cold room is expected to make a good job. Re-

verse this picture, and the varnish will crawl and shrivel on the body.

*Consistency* is a great virtue. My experience is, that nine-tenths of the trouble of shriveling and crawling of varnish occurs in the fall before fires are used. In the spring, when they are left off, *cold shops, and varnish piled on thick*, is generally the cause. Give the carriage-part the same labor and chance you give the body, and it will look as well, and not shrivel with as light a coat as that put on a body. Facts are stubborn things.

A few words on the blistering and cracking of varnish. You and I remember when a paint-shop had a large platform on which to run out work, to sun it. Each coat of paint, varnish, &c., was exposed to the sun, and thoroughly dried before laying on another coat. Also to make a good job, it took as long, or longer, to paint a carriage then as it does now to get up a finished one from the stump. A carriage now never sees the sun, until finished, and may stand in the repository for months; but when exposed to the sun, what does reason and common sense teach? It must blister, or crawl, or both. It is not dry, and dry it must in the sun, and if so it must give somewhere, and it not unfrequently cracks through in long and deep cracks to the *bare wood*, or blisters and *peels off*, and why? It seems almost useless to give an answer. Probably not one single coat was dry before another was laid on. And until boss coach-makers tell their customers they cannot build them a coach in less than six months, instead of six weeks, as is now the case, complaints will occur. The best painter on earth cannot remedy the evil. Steam speed on our railroads, and steamboats on our rivers, do very well, but it will never do in coach-painting.

OLD FOGY.

[The above communication from "Old Fogy," as he styles himself, is one of the most sensible articles on the subject of varnishing we have read *in an age*. We venture to say that it is worth more to the painter than folios of the theories which we see written on the subject by persons of less experience. As our correspondent has promised us more on this subject, our readers may reasonably expect another treat soon. In a private note the author gives us encouragement that we shall also receive his experience on "the sweating out of varnish."—Ed.]

### GUM COPAL.

This is a valuable and singular kind of resin, which, according to some authorities, naturally exudes from different large trees found in the East Indies. Dr. Ruscheuburger still asserts, that it is a gum found about the roots, whence it is dug up in large quantities, and is often obtained from places where the tree had been grown many years before. The best copal is of a bright yellow color, transparent as amber, found in small rounded lumps or flat pieces, hard and brittle, but easily reduced to powder. Copal is liable to be confounded with gum anime, which exudes from the roots of the locust (*Hymenaea Courbaril*).

According to M. Landerer there are three varieties of copal, differing from each other in their properties, viz., Brazilian, West Indian, and East Indian or Leventine copal. The latter variety is sold in the bazaars of Jerusalem, Mecca, and other places, as a species of choice incense, and it plays a very leading part in all the fumigating drugs of the East.

The people employed in the collection of the copal in Palestine and Abyssinia dig deep trenches around the tree, and then collect and sort the pieces of gum which fall into them. They are afterward freed, as much as possible, of the earth that adheres to them, by washing and stirring. African copal is obtained from a species of *Hymenæa*, and from fourteen to seventeen tons are imported to Liverpool from Sierra Leone. New Zealand copal is the Kauri gum; Brazilian copal is the produce of *Trachylobium Martianum*.

In commerce, copal is distinguished into the hard and soft kinds. The chief of varieties of the former are: 1st, copal from Madagascar (in large flat, yellow pieces), which, when cold, is tasteless and odorless, but when heated, diffuses an aromatic odor; this kind is rather rare. 2d. The East India copal, the most common commercial variety; it is rough on the surface, bearing the impression of sand. The best specimens are colorless, and in small pieces, constituting the copal from Calcutta. A third, but very small variety, is brought from the Brazils and south of Africa. In the Calcutta variety, pieces of all the other kinds are to be found; nor is a distinction readily to be made between the white copal of Calcutta, and the yellow resin of Bombay; the difference appears to depend only on the care bestowed on the selection and purification of the pieces. The various resins, from anime to soft copal, Indian, and Madagascar, seem to form a continued series, differing only in the increased quantity of oxygen they contain. A curious variety of copal is that in the pebble form, rounded by the action of the water.

Copal is the Mexican generic name for all resins. In the collection of products from Mexico shown at Paris, there were several resinous gums, of which no particulars, however, were obtainable—one, an unnamed resin, very much like anime; another, termed Axin resin which burns with little flame, and blackens; a whiter kind, called Archipan resin, has much the same properties, and a bitter flavor. A nominal copal from the same quarter resembles very closely the resin of Tacamahaca, being of a white color, with a coniferous smell.

Copal varnish for fine paintings is made by fusing white resin in a clean iron vessel, then pouring into it two gallons of clear hot linseed oil to every eight lbs., boiling it for fifteen minutes, then pouring in three gallons of turpentine when cooled down. It is now stirred, is strained, and, if too thick, more turpentine is added. Coach varnish is made in the same manner, only the oil and the resin are boiled for four hours, until quite stringy, when it is thinned with turpentine. When this varnish is employed without a drier it is very pliable, but it takes months to dry before it can be rubbed down and polished. To make it dry quick, some sulphate of zinc is mixed with it. The durability of varnishes, however, is injured by dryers.

**QUICK DRYING HARNESS BLACKING.**—Break half a cake of white wax into an earthen pan, and just cover it with oil of turpentine. Place over the pan a board, to keep out the air. Let it stand for twenty-four hours, or until formed into a paste. Then, in another pan, mix a pound of the best ivory black with neat's-foot oil, until it assumes a thick consistency. Mix the contents of both pans together, and bottle for use.

A GENTLEMAN, who had a scolding wife, in answer to an inquiry after her health, said she was pretty well, only subject at times to a "breaking out in the mouth."

## Trimming Room.

### LINING BUGGIES WITH CORDUROY.

OUR country readers may be somewhat startled when they are told that corduroy has become so highly dignified, as to find a place in the lining of buggies; but then such is the fact. Some of the finest New York buggies are now trimmed with this material. For the falls and cushions it makes a cheap, strong, and durable article: which qualifications are sufficient to cause it to supersede the enamelled leather heretofore universally in use. The corduroy (of a drab color) is much better than leather, and it is not so liable to injure the dresses of the ladies. Its use does away with ornamental stitching, and in this particular avoids a great deal of expense in trimming. For a light no-top buggy, where the seat rave is made to represent a trimmed one when painted, this style of lining is very neat and tasty.

### A SIMPLE MODE OF SECURING CUSHIONS TO SEATS.

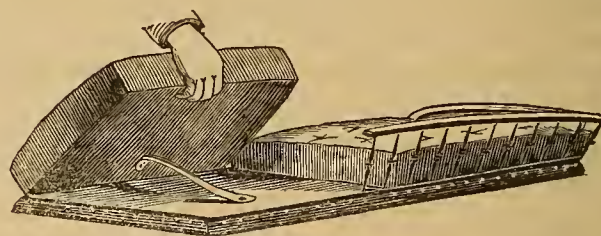

HERETOFORE it has been the common practice to secure the cushions of buggies and wagons with a strap passing over them, and fastening in front with a buckle or knob. As an improvement, the plan illustrated in our engraving has been adopted, which is not only less expensive, but also simple and efficient, entirely doing away with what has always been an unsightly appendage. The strap should be strongly sewed to the cushion-bottom at one end, and secured to a knob at the back of the seat.

### DAMASK—A QUERY.

AT the end of a business letter, we find the following request from a correspondent:

If it would not be too much trouble for you, I would be pleased to have you answer the following questions, as I have had considerable contention with my employers and others on the subject:

1st. Are figures on damask goods raised or depressed on the face side?

2d. Are they (the figures) formed by the *warp*, or the *filling*, on the face side?

3d. Are damask head-linings folded right side out!

I am a carriage-trimmer, and have always put damask in, with the inside (as folded) out, and for the following reasons: I claim that the "warp" always forms the body, or ground-work—or finish—of goods, and that it does in

damask, and that the flowers or figures are formed by the filling thrown over the warp on the right or face side; hence the figures are raised on the face, and depressed on the back. I hold that figures on any thing are raised *always* upon the ground-work—not the ground-work upon figures. I think this holds good in all goods, laces, &c., which I have ever examined. Please give me your opinion, and oblige,

Yours, respectfully,

H. R. W.

[To the first question we answer, they are merely the effects produced by the interlacing of the threads, and perhaps a critical explanation would be given, were we to say, the figures are raised in the filling whilst the warp is depressed in weaving. This also answers the second question.

To the third we say, the manufacturer in folding always puts the face-side out, for *appearance*' sake.—Ed.]

#### EXPLANATION OF STITCHING PLATE E.

*Drawn from the Designs of various Correspondents.*

Nos. 1, 1, is a single design, severed at the centre, the two halves, when joined at A A, forming a complete pattern for the inside leather-lace of a buggy or carriage-top—contributed by F. FREY, of Ill., who likewise furnished the design for No. 2.

Nos. 2, 4, and 5 are different figures for the corners of a leather boot.

No. 3 is a half-figure for a cushion-front.

No. 6 is a figure for the corners of a dash.

These last are from different friends of this work, who will please accept our acknowledgments for their kindness.

### The New York Coach-Maker's Magazine.

AUGUST 1, 1859.

E. M. STRATTON, Editor.

#### TO READERS AND CORRESPONDENTS.

**PUBLISHER'S NOTICE.**—As the conductor of this Magazine is determined to make it as useful and interesting as possible, a general invitation is given to all in the different branches of the profession, to contribute to the different departments of the work, such improvements or new features as they may be cognizant of, anywhere in the United States, and when such matter is charged (if used) it will be liberally paid for. We hope that none will be deterred from writing or sending us sketches, under the impression that they cannot write well enough. We take it upon ourselves to properly see to that matter, under the conviction that the purest ore is often found imbedded in the most unsightly rubbish. The craft will much oblige us, if, when patentees call upon them, they would point out to them the superior advantages this work offers for placing their inventions before the craft. In this way much can be done in furthering the objects of this publication.

 All letters directed to this office on business, NOT relating to the Magazine, but solely for the writer's benefit, must inclose a stamp; if requiring an answer, two red stamps. Orders for a specimen number must be accompanied with nine three-cent stamps. When these terms are NOT complied with, no attention will be given them.

C. H. O., of Ga.—Your Magazine has been regularly mailed every month. Why you "have received nothing at all" for the last two months, we cannot tell.

#### THIS COACH-MAKING AGE.

THAT the present is an age of progressive improvement, none but an individual steeped in stupidity will undertake to deny, and none but the veriest "old foggy" dispute. We shall take it as granted then, that such is the fact, since every body admits that it is; but in what these improvements consists, may be a legitimate subject for inquiry.

Those who have but recently come upon "the stage of action," may not be sufficiently impressed with the fact, that "matters in general" have materially changed within the past thirty years. A time is within our memory when two days were often spent in journeying fifty miles, where two hours are now amply sufficient for reaching the same point. Moving literally as it were upon the "wings of the wind," at a comparatively small expense in money—not to mention the large amount of time, which, according to Franklin, is money—we may in a very few hours travel to the very limits of our vast continent, for business or pleasure; or make a "flying visit" across the broad Atlantic, to another division of the globe, in search of health or wisdom, with which to satisfy the longings of an ambitious mind. In brief, there is scarcely any department of Mechanical, Mercantile, or Agricultural business which has not the impress of progress visible in it.

But probably in no special department of mechanical pursuit, has greater improvement been made, than in the one to whose interests this Magazine is devoted. Does any one doubt the fact, we will engage to convince him in ten minutes that the position we have assumed is correct. We have now in our possession some twenty-five drafts of the vehicles our fathers made and rode in, thirty years ago, and an interesting collection it is. We have half a mind to present the reader with a sight of one as a picture of "the olden times." Perhaps we may yet do so in our series of chapters on "Coach-making Historically Considered and Incidentally Illustrated." Twenty lines of this column would be amply sufficient in which to enumerate all the carriage-manufactories in these United States, existing thirty years ago. Now, the single State of New York alone has, according to the State Business Directory, no less than *sixteen hundred and ninety-nine*, which, allowing five persons to each shop, would give 8495 as being engaged in the business. In Maine, we find there are 387 manufactories; in New Hampshire, 178; in Rhode Island, 75; in Massachusetts, 514; in Vermont, 203; in Connecticut, 207; and how many there are in Pennsylvania, New Jersey, Ohio, Indiana, and Illinois, which are each thickly planted with them, we have no means of deciding exactly. We have sufficient data, however, for warranting us in estimating the firms engaged in coach-making to be not less than *twenty thousand*, which, according to our estimate, gives *fifty thousand* souls who are engaged in the business within the bounds of this Union. Besides, there are many not included in the

above enumeration, who are classed as Wheelwrights, Blacksmiths, Trimmers, &c., who have more or less to do with the business.

Where the productions of so many hands find a market would form of itself an interesting subject of inquiry had we the time and space to follow it out. This may, however, engage our attention at another time. We have above intimated that the business has undergone a great change within the past thirty years. This is found not alone in the great multiplicity of those engaged in manufacturing, but in the variety as well as the beauty of our carriages. That which strikes the attentive beholder the most forcibly is, the improved beauty in outline and elegance of finish which the American coach-maker in these modern times imparts to his manufactures, when compared with those of earlier times. The transatlantic workmen may insist that we have learned much from them. Very true, perhaps; but then, with our characteristic confidence, we assert that we have outstripped them, and gone far in advance, in beauty of model and elegance of finish, of all other nations.

We shall say nothing here—as it is foreign to our present purpose—of the rapidity in which carriages are now built, which enables the manufacturer to carry on his business with less capital, but which we think would be much more durable if they were longer in being constructed; nor of the improved facilities offered in obtaining the materials in detail for so doing. Any one, by looking over our advertising pages, will not fail to discover this. Formerly we were compelled to get almost every thing out of “the ruff,” now we have them prepared and ready to our hand, thus saving much hard labor. On the introduction of machinery, a few years ago, a great complaint was made, that its use would injure the interests of the working classes. Has it had that effect? On the contrary, we think it has benefited them. Let us inquire into this matter a little.

About the year 1832, when such a thing as machinery was scarcely thought of as an auxiliary in carriage-making, good workmen could only command \$1.25 per day. Now they get from \$1.75 to \$2. The usual price for making wheels was \$5.50, and then the mechanic had to mortice his hubs by hand, “dress up” his spokes, and “get out” his felloes from the plank, etc. Now, with the spokes ready dressed, rims bent, and hubs morticed, he gets \$4 per set. Under the ten-hour system he finds time for the cultivation of his mind, whereas, formerly, he was confined to his work-bench sixteen hours out of the twenty-four. We might pursue this subject to equal advantage, showing that, socially and pecuniarily, the condition of those engaged in coach-making has improved very much within the past quarter of a century; but the length of this article admonishes us to postpone the subject until another time.

#### AN EXTENSIVE HUB MANUFACTORY.

Our readers will have learned by this time that we are not accustomed to “blow” for every advertiser who may generously favor us with his patronage; but on visiting Newark a few days since, we called upon the Messrs. Miles & Co., in the way of business, and became so deeply interested, in passing through their establishment, that we cannot resist the temptation of going a little into detail respecting it.

This manufactory is situated on Summit street, at the back of the city, on high ground, overlooking the surrounding country. It occupies, including sheds for seasoning timber in the log, and other purposes, an extensive area of ground, which, in a very short time, must become exceedingly valuable. Here the stock is seasoned in the “natural way,” as the proprietor—and as we think correctly, too—is of the opinion, that the use of steam, or any other artificial means, has the tendency to injure the qualities of the wood. This stock chiefly consists of gum oak, and elm, the two last growing of the very best quality in the immediate vicinity of this establishment.

With an engine capable of imparting a vast amount of power, run entirely by the fuel supplied from the chips made in boring and morticing the hubs, this establishment can supply daily, from the hands of each workman, twenty sets of morticed hubs. So perfect is the machinery here, that, without his knowledge, we timed a workman, and found that he bored and morticed a set of six-inch hubs in the space of two minutes and fifty seconds! giving the correct bevel, and making a perfectly smooth mortice, ready for driving the spoke.

The boxes and lines of hubs, ready turned, of about which 40,000 sets are kept ready for sale, and so neatly too, was surprising to us. Some of these had been turned two and a half years already. Here we found all sizes, from the smallest ever made to that twenty inches in diameter. A large proportion of these last are sent to the California market. With the facilities at hand, we can scarcely imagine a case where this manufactory would not be prepared to supply any order that might be received, at the shortest notice possible.

There is another less extensive hub-manufactory in this city of 60,000 inhabitants, conducted by our friend, Mr. Alexander Russell. These two factories will no doubt be able to supply every demand upon them from the craft.

#### OUR NEW ENGLISH COTEMPORARY.

As ANNOUNCED in our July number, “The Carriage-Builders’ and Harness-Makers’ Art Journal,” published in London, has made its appearance. Having examined it thoroughly, we must say that the engravings and matter generally are very creditable to our transatlantic cousins in the craft; and which, if not liberally sustained, will prove

a lasting disgrace to the reputation of that influential class of mechanics in England, for whose benefit it was originated. Of this, however, we shall learn hereafter.

For ourselves, we wish it success ; and while we pray that his "shadow may never be less," we would cordially extend to its Editor the right hand of friendship, hoping that he may be ably sustained by the assistance of practical correspondents, without which—as all who have tried it have found—the chair editorial will prove any thing but easy. We shall transfer to our pages, from time to time, such matter as we may deem interesting or instructive to our readers.

The publisher proposes to give "practical directions in all branches of coach-building, with working-drawings and colored illustrations, making a beautiful show-book of carriage architecture, of the most approved designs and patterns of all descriptions of pleasure, domestic, public, railway, government, and agricultural carriages ; introducing and explaining, from time to time, all new patents and improvements in springs, steps, wheels, axles, and lamps ; designs in metal chasings, steel and iron work, silk and lace, carriage furniture, heraldry, &c., &c. ; with an inquiry into the combination of paints and varnishes, and the contrasts of colors, including working-drawings and designs in harness-making and saddlery."

The price, each part, is 2s. 6d. sterling.

A PERSONAL COMPLIMENT.

THE writers of the letter given below will pardon us for the liberty we have taken in giving that to the public which was only designed for private purposes, but who are entire strangers to us. It exhibits so well one of the golden links in the chain of friendship, with which the public has bound us to its interests, that we cannot resist the temptation of printing it for the special benefit of very few whose jealous minds and mean dispositions have placed them in the position of the dog in the manger. We have a few more letters of the same tone in our drawer, but to give them all would not sufficiently interest the public, to warrant us in burthening our columns with the space they might occupy :

BINGHAMTON, July 8th, 1859.

E. M. STRATTON, Esq.—*Dear Sir:* Not long since we received a circular from you, informing us of the existence of a Coach-Maker's Monthly Magazine. We feel very thankful indeed that a gentleman, whose character and reputation stands as high as Mr. Stratton's, is engaged in conducting the enterprise, for we are confident of its success. Instead of regarding the magazine as a medium and VEHICLE for speculation prostituted to an unworthy purpose, we look upon it as really a "magazine" to which the craft may resort for facts and reliable information, and as representing the highest interests of the "profession." Inclosed please find \$3 for a copy of the Magazine for one year, and believe us, dear sir, with the warmest wishes for your success,

Your friends,

MILLER, FRENCH & Co.

LEGAL CORRESPONDENCE.

THE following letters, lately actually passed between an eminent legal firm and their clients, a well-known carriage-firm in New York—the names only being changed ; the case of "Pole-evil" alluded to, was a suit in relation to a lot of damaged carriage-poles. Their moderate charges and prompt way of doing business should recommend these legal gentlemen to the craft, and we promise to publish their card at one half the usual rates, should they decide to extend their business :

NEW YORK, 31 May, 1859.

Messrs. FERGUSON & BROWN :

GENTLEMEN—Please find inclosed twenty-one cents—less charges—the amount of the second dividend of the estate of Edward Pebbles, deceased, awarded to you on the late division. After this sudden influx to your coffers, gentlemen, as you drive down our spacious avenues in one of your luxurious chariots, receiving the adulations of your fellow-citizens, please bestow a glance on your humble attorneys as they plod their daily way to musty papers and black letters. \* \* \* \* \*

"Moderation in all things" is a good motto—do not, therefore, squander the inclosed in riotous living, fast horses, or fast things of any description.

Our charge for appearing as your counsel in the proceedings, &c., will be one cent, which we deduct.

Yours, respectfully,

GRAB, SCAREM & PULLEM.

Account.

Estate of Edward Pebbles,

To Ferguson & Brown.

Division of assets,.....	\$00 21
G., S. & P.'s professional services,.....	00 01

Send herewith,.....	\$00 20
---------------------	---------

NEW YORK, 31st May, 1859.

DEAR MESSRS. GRAB, SCAREM & PULLEM :

We received your kind note of this date, With the heavy remittance collected, From the late Edward Pebbles' estate— Together with nearly three pages Of the very best sort of advice, And we wonder how you can afford it At such a ridiculous price.

Only think! three skillful attorneys, Bred from their youth to the law, Chockful of Chitty and Blackstone, And an unusual quantity of "jaw," Should devote their wonderful energies, And legal lore—worthy of Kent— To wrest from the hands of the spoiler, Such a prize, and charge but a cent!

Yes, gentlemen, you greatly astonish us :

We never expected to see So much legal wisdom devoted To gain so modest a fee.

We accept your advice and remittance, And will endeavor to profit by each— The one will give us much wisdom, And the other will help us to reach

That proud and lofty position,  
Only won by the judicious few,  
Who struggle and labor a lifetime,  
To die—"as rich as a Jew."

But this sudden influx to our coffers  
Shall never disturb, as you fear,  
Our respect for poor people and lawyers,  
And others who bring up the rear  
Of that motley group on the sidewalk,  
Who sometimes wonder and stare  
At the "nobs" who ride in their coaches,  
Or drive a "three-minute pair."

As of yore we will nod when we meet you,  
And pity the miserable fate  
That keeps you all day at the "Circuit,"  
And at night in your office so late,  
Burning "gas" over intricate cases,  
Or conning some eloquent plea  
That shall "muddle" the judge and the jury,  
And win double the usual fee.

Oh! no, we will never forget you;  
You shall stand as you did before,  
Turning screws on our doubtful debtors,  
As our "humble Attorneys at Law."  
You shall have all our heaviest cases—  
Including the one about "Poles"—  
By the way, that's a case of "Pole-cvil"—  
Give 'em fits, the miserable souls.

One word more and we'll close up.  
(We could, however, enlarge.)  
We think you will find it important  
To learn Mr. Scarem to "charge;"  
Place before him all the examples  
And longest precedents in law—  
And perhaps he'll find a "case settled"  
In a report of the "Crimean War."  
He'll see, if he looks into "Tennyson,"  
The matter reported in full—  
The terrible "charge of six hundred"  
In the case where the plaintiff was Bull.  
Let him hang up, right off, in his office,  
In letters sufficiently large,  
Wrought in brass, three words, as a motto,  
CHARGE! SCAREM, CHARGE!!

Your obed't serv'ts,  
FERGUSON & BROWN.

#### THE STITCHING PLATE.

Those who may be curious in such matters will notice, that we have made such changes in the engraving and printing of our stitching plate—in contrast with those of the first volume—that a marked improvement is visible. The quantity of ink required in printing from such blocks as we used last year, imparted to the paper, in a short time, such a *smoky* stain, that it did not satisfy us. We are very happy to find that these objections are overcome, while, at the same time, the figures for stitching are equally available.

A FEW MORE LEFT.—We can still supply the first volume of this Magazine, either bound for \$3.50, or in numbers, for \$3.

#### INVENTIONS APPERTAINING TO COACH-MAKING AT HOME AND ABROAD.

##### AMERICAN PATENTED INVENTIONS.

April 26. SCREW WRENCH.—Albert D. Briggs, of Springfield, Mass.: I make no claim to a nut and screw applied to the movable jaw and main bar of a wrench, and for the purpose of operating or moving the said jaw relatively to the stationary jaw; nor do I claim the invention or improvement which constitutes the subject of the said patent of the said Merrick; nor do I claim the mode of operating the movable jaw, as shown in the patent of D. H. Chamberlain, dated March 20, 1849, wherein the tubular handle has a screw formed within it, and rotates on the shank without having any longitudinal motion thereof, and furthermore, such rotary handle is not a separate and distinct thing with reference to the handle, G, as described, as appertaining to my improved wrench. There are important differences between my improvement and the other inventions as cited.

But I claim the application of the sleeve, G, to the nut, F, and the handle, D, so as not only to be capable of turning with and rotating the nut, but of moving longitudinally on the handle and with the nut, in accordance with the movement of the movable jaw, F, on the shank, A.

May 3. FASTENING FOR CURTAINS OF CARRIAGES, &c.—William Z. W. Chapman, of New York City: I claim a curtain knob fastening, constructed and arranged substantially as set forth, so as to be readily opened from the base or on either side of the curtain, as described.

WHEELWRIGHT'S MACHINE.—T. L. Hawkins, of Sturgeon, Mo.: I claim the arrangement of the several parts, substantially as described, for the purpose set forth.

MODE OF ATTACHING HARNESS BREECHING TO WAGON THILLS.—Aaron Parker, of Coventry, N. Y.: I claim the mode of attaching the hold-back straps to thills of vehicles, by having a metal ring to slide under a spring snap, in such manner that it will unfasten of itself when the traces are unhitched, as set forth.

May 10. CONVERTIBLE CARRIAGE SHAFTS.—R. J. Colvin, of Lancaster, Pa.: I claim, *first*, the attachment of removable shafts, by means of adjustable braces, I I, and the hinged caps, Z Z, of the pole crab, N.

*Second*. The curved or segment bars, A, forming a transverse horizontal slot, in which the shafts are supported at their rear end, both when separated in the ordinary way, and when united together as a pole.

*Third*. The hinged and pivoted thill attachment for accommodating the width of the same to the different positions of the clips upon the axle.

METHOD OF STRAPPING WOOD IN BENDING.—John I. Field, of Syracuse, N. Y.: I claim the method for connecting metallic straps for bending timber, when the parts are so arranged as to operate in connection with the forming frames.

MECHANISM BY WHICH EMPLOYEES REGISTER THEIR TIME.—Benj. T. Harris, of Brooklyn, N. Y.: I claim, *first*, the manner of mounting the cylinder, D, on the spring barrel, f, and with the connecting coupling, 3.

*Second*. I claim the binding plate, d, fitted and acting to retain the ends of the paper to the cylinder, D.

*Third*. I claim the arrangement and manner of constructing the slides, i i, and the impression point, m m.

*Fourth*. I claim the rollers, I, and their pawls, o and p, in connection with the slides, i i, and openings, k, in the front plate.

SPOKE SHAVE.—Benj. Tolman, (assignor to himself and A. T. Ramsdell,) of Pembroke, Mass.: I claim an improved spoke shave, constructed with an adjustable knife and an adjustable throat-gage, arranged and applied to the stock and so as to move with respect to one another.

BENCH PLANE.—Wm. S. Loughborough, of Rochester, N. Y.: I claim, *first*, The combination of the screw, 2, (which takes effect in the projection, R,) spring or yielding-cap, C, bit, B, and screw, 1, for the purpose of varying the cut of the bit, and at the same time, and proportionally, the space of the throat, the base of the bit, B, being the fulcrum upon which it



swings when said changes are made, the said combination being applicable for the adjustment of the bit in all kinds of planes.

*Second.* The adjustable parallel fence, F, constructed with diagonal slots, D, for the set screws, Y, said fence being applicable to match planes, and also the stop, P, with the slot running up diagonally from the face, the set screw, K, and the guide pin, N, keeping it in position, said stop being applicable to panel plows and dadoes.

**LATHES FOR TURNING IRREGULAR FORMS.**—Charles Spring and Andrew Spring, of Boston, Mass.: We claim the combination of a gripping chuck, by which an article can be so held by one end as to present the other free to be operated upon, with a rest preceding the cutting tool, when it is combined with a guide cam, or its equivalent, which modifies the movement of the cutting tool, all operating together for the purpose set forth.

**HAND-PLANE.**—Simeon S. Dodge, of Sunapee, N. H., (assignor to himself and Edmund Burke, of Newport, N. H.): I claim, *first*, the curved adjustable cap iron, D, constructed and operating substantially as described.

*Second.* The combination of the adjustable cap iron, D, with the bolt, H, the set screws, G G, the thumb screw, E, and the break iron, C, constructed and operating substantially as described.

**FICTITIOUS ENAMELED LEATHER.**—James W. Monroe, (assignor to John Southworth and Wm. R. McKenzie,) of Fall River, Mass.: I claim, as a new article of manufacture, the within-described artificial leather, composed of two or more thicknesses of cloth, united by cement and varnish, as set forth.

May 17. **MACHINE FOR UPSETTING TIRE.**—C. L. Crowell and Robt. Smith, of Peoria, Ill.: We claim the combination of the lever and the intermediate slide, arranged substantially as described, for the purpose of giving movement to the sliding jaw.

May 24. **HUBS FOR CARRIAGE WHEELS.**—Luther T. Hazen, of Coventry, N. Y.: I claim inclosing wood hubs for carriage wheels, or other vehicles, with metal cases which form the pipe-box and bands, in the manner described and for the purposes set forth.

**ATTACHING THILLS TO AXLES.**—John Miller, of Bucyrus, Ohio: I claim the adjusting and securing the hook, s, on the pin, i, by means of the circular face, b c, on the jaws, D D, and the shoulders, r r, on the iron, E, substantially as and for the purpose set forth.

**PORTABLE WAGON JACKS.**—Henry Stowell and Lorenzo Spencer, of Placerville, Cal.: We claim the peculiar arrangement, combination, and adaptation for the purpose of raising the axles of wagons and other heavy bodies, to which the foregoing invention may be adapted.

May 31. **WHEEL JACK FOR CARRIAGES, &c.**—Henry Hooton, of Mass., and J. G. Bicknell, of Cambridgeport, Mass.: We claim, *first*, the combination of the hollow box, a, with the lever, D, the front jointed pawl, C, the back pawl, C, and the notched shaft, B, operating substantially as described.

*Second.* The combination of the button, E, the spring, F, the catch, G, the button, H, and the jointed connecting rod, K, operating substantially as described.

June 7. **MONEY BOXES FOR STAGES, &c.**—T. W. Gibbons, of Franklin, N. J.: I claim, *first*, the box, A, provided with the drawers, B D, the former having a flap or door, h, in its bottom, and arranged to operate substantially as and for the purpose set forth.

*Second.* The change slide or plate, G, one or more used in connection with the tubes, s, and arranged relatively with drawer, B, to operate substantially as and for the purpose set forth.

*Third.* In combination with the drawers, B D, and change plate or plates, G, the bell, g, and index n, and dial o, arranged substantially as and for the purpose set forth.

**OMNIBUS REGISTER.**—Robt. F. White, of New York: I claim the spring platform, B, arranged in combination with the hammer, K, and with the index k, and operated by the lever, F, or its equivalent, substantially in the manner and for the purpose specified.

**SAW-FILING MACHINE.**—T. E. King, of West Andover, Ohio: I claim the suspending the file-holder upon arms, as herein set forth, so that it is susceptible of adjustment horizontally, vertically, and obliquely, and in combination with the curved faced slot in the holder, as described.

**ROTATING DUMPING-CAR.**—William A. Hawkes, of Corinth, N. Y.: I claim the arrangement and combination of the rotating platform, C, provided with dumping-boxes, L, with the shaft, K, and gearing, D E H b G i i m, and the clutches, d j, substantially as herein shown and described, so that the car may be propelled and the dumping-boxes rotated by turning shaft, K, as desired, all as set forth.

**OMNIBUS REGISTER.**—H. C. Howells, of New York City, and J. C. Howells of Madison, Wis.: We claim, *first*, the employment of a yielding platform to determine the value of the entry or fare, and in combination with doors, or equivalent devices, to secure the registration of persons standing upon it, previous to their ingress or egress, substantially as specified and set forth.

*Second.* We also claim the employment and use of the circular or segmental doors, or equivalent devices, having within the area of their action a yielding platform, operating substantially as set forth and specified.

*Third.* We claim, in combination with the yielding platform, G, an operative lever, N, and vertical rod, M, and puppet Q, or their equivalents, substantially as set forth and for the purpose specified.

*Fourth.* We claim the pin, or bolt, s, in combination with the arm, O, attached to the vertical rod, M, or their equivalents for communicating motion to the registering levers, S and T, by the action of the jointed arm P, substantially as specified and set forth.

*Fifth.* We also claim the registering levers, S and T, operated as set forth, or their equivalents, and in combination with the registering ratchet-wheels, U and V, and the spring pawls, m m, together with the double dial, X, for registering the whole or half entries or fares, substantially as set forth and specified.

*Sixth.* We also claim the stationary brushes, and the arrangement and combination of levers and rods, or their equivalents, for operating the doors and steps, substantially as set forth and described.

June 14. **HANGING CARRIAGE BODIES.**—Leman C. Miner, of Hartford, Conn.: I claim, *first*, The application of the double-jointed shackle, H, to the front axle, whereby the vertical position of the spring and axle is sustained, and the fifth wheel and appendages dispensed with.

*Second.* The back axle braces with double joints, B B, to admit a free and easy vertical motion of the springs and supporting the axle in its upright position, substantially in the manner as described.

**THE CONSTRUCTION OF SLED RUNNERS.**—John M. Spooner, of Springfield, Mass.: I claim making both of the runners and the bearers of a sled or sleigh, or other similar vehicle, of one continuous piece or rod of steel or other metal, substantially as set forth.

#### RECENT EUROPEAN PATENTED INVENTIONS.

January 8. William A. Lyttle, General Post Office, Ireland—Taking the place of Springs in many, if not all, of the combinations into which they enter, and also for equilibrating a varying force or weight.

January 11. John Biers, the younger, 38 Rochester Road Kentish Town, St. Pancras—A self-acting carriage-wheel brake.

February 8. Thomas Storer, Birmingham—A new or improved funeral carriage.

February 4. Louis Bonneau, 279 Rue Saint Dennis, Paris—Improvements in apparatus for registering the time carriages are employed in conveying persons from place to place, and also in moving from place to place when unoccupied.

February 10. Hector Inger, 3 Red Lion Square, Holborn—The improvement of blinkers used by horses whilst drawing, to be called the "patent safety blinker."



**HORSE-BREAKING EXTRAORDINARY.**—The world has lately been startled by the wonderful powers displayed by Rarey and his pupils over the horse; but the *rare* invention of that singular genius, Professor Lay-em-straight, eclipses all other modes of accomplishing the like object. The Professor is an "original" genius in his way, and having secured a patent for his "Combined-anti-frictionless-quick-detaching-axle-tree," conceives the *original* idea of trying its *virtues* in "breaking to wagons" his spirited horse. The vicious animal—as the "disordered" state of the Professor's wagon-dash evinces—appears, on level ground, to have had it all his own way; but on descending a hill, he recollected that a classical author once said: "*Facilis descensus Avernus,*" and at the instant, the horse being seized with "*a fit of nature,*" stumbling, the Professor at once uses the advantages his "inventive genius" has invested him with, with the result our artist has depicted. The result is very satisfactory to—the Professor.

Should the invention not prove as remunerative to the patentee as did Rarey's "secret," still, we have no doubt it will prove as profitable as three-fourths of the patents taken out at Washington; but his fame!—our Magazine will herald that "all over creation!"

#### SUPERIOR LEATHER-WASHERS FOR CARRIAGE AXLES.

W. H. SAUNDERS, Patent Axle manufacturer, Hastings on the Hudson, Westchester co., New York, has invented and perfected machinery for cutting and finishing Leather-Washers for Carriage Axles. This invention enables him to supply a **BETTER** and **CHEAPER** article than any other manufacturer. These Washers are cut from the **HARD BACKS** only, of *heavy sides*; all butts and bellies being excluded. Washers cut to any given sizes, to suit any make of Axles.

Patent Homogeneous Steel Axles, 5-8 in. and upwards; Patent Homogeneous Steel Tire, for light-wagons; Miner, Stevens & Saunders' Patent Shaft and Pole Couplings (neither of which can be had from any other manufacturer); also all styles and sizes of Carriage Axles, made from the celebrated Low Moor, Bowling, and other first quality irons, got up, as usual, in the manner which for the past twenty-seven years has secured such decided approbation.

Letter orders, with references, promptly attended to.



#### A. L. CUTLER & CO.,

MANUFACTURERS OF

No. 1. and 2 Coach, Elastic or Imitation

English,

WEARING BODY,

Quick Drying, &c,

### COPAL VARNISHES,

No. 43 India street, Boston.

Factory, Island st., Roxbury.

#### WILSON & BELDING,

RAHWAY, N. J.,

Manufacturers of seasoned morticed and unmorticed

### HUBS

For Drays, Carts, Omnibuses, Coaches, Rockaways, and Buggies.  
Please call and examine our Stock before purchasing elsewhere.



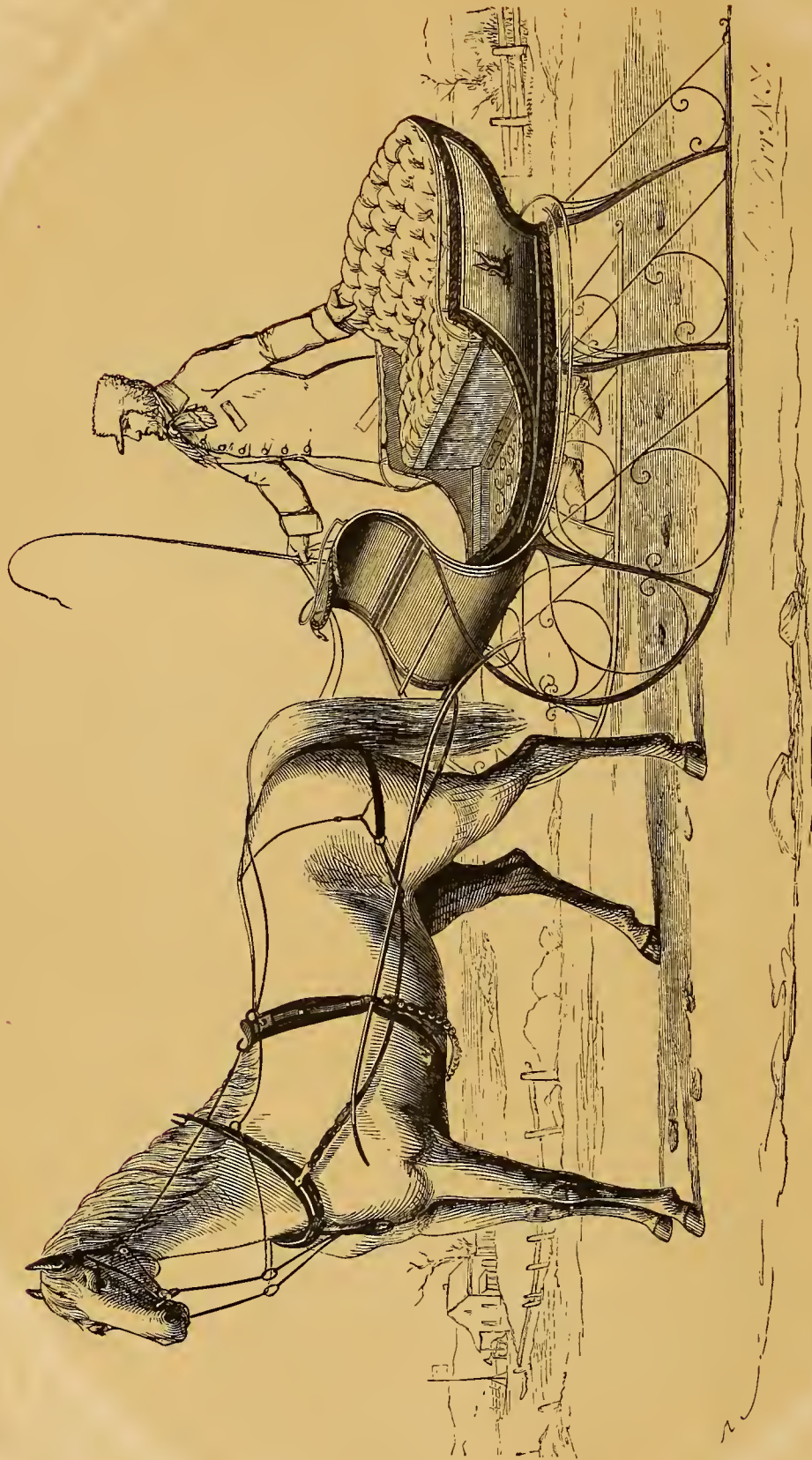

THE PORTLAND SLEIGH.—SCALE UNCERTAIN.  
From Messrs. Kimball & Clement, of Portland, Me. See remarks on page 69. 1859.

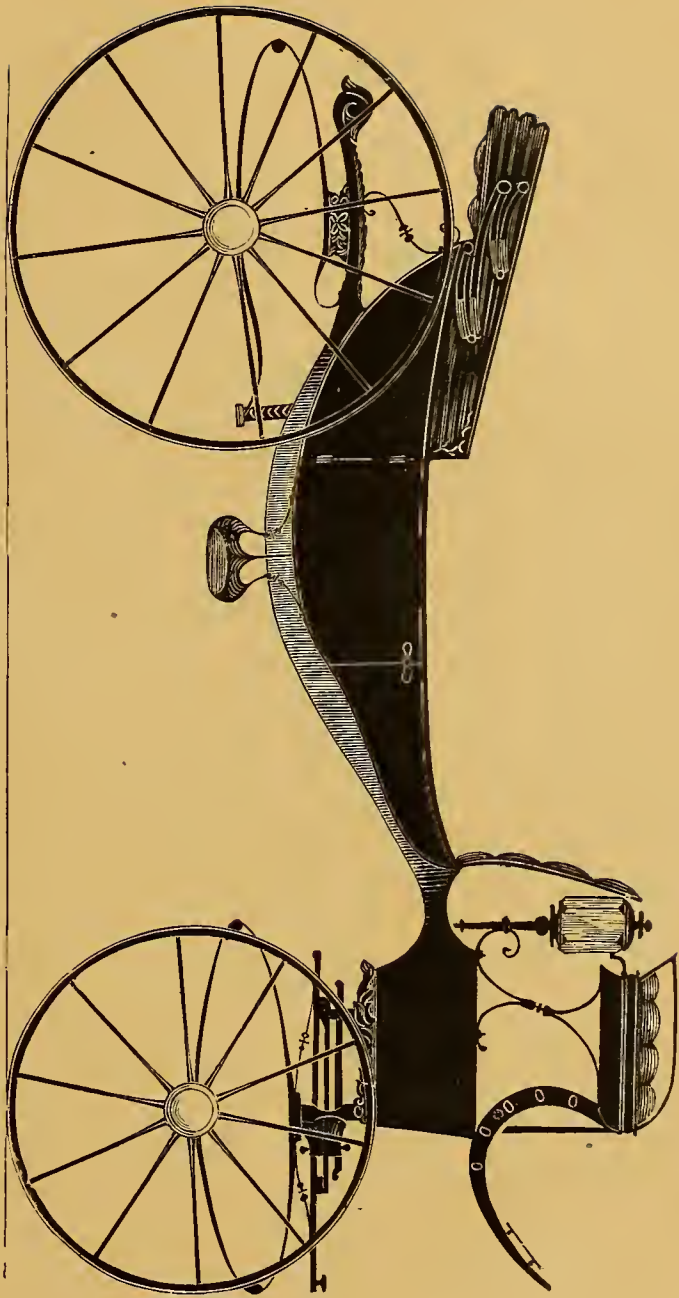

FYANS' BRETT.— $\frac{1}{2}$  IN. SCALE.

Engraved expressly for the New York Coach-Maker's Magazine.—Explained on page 70.





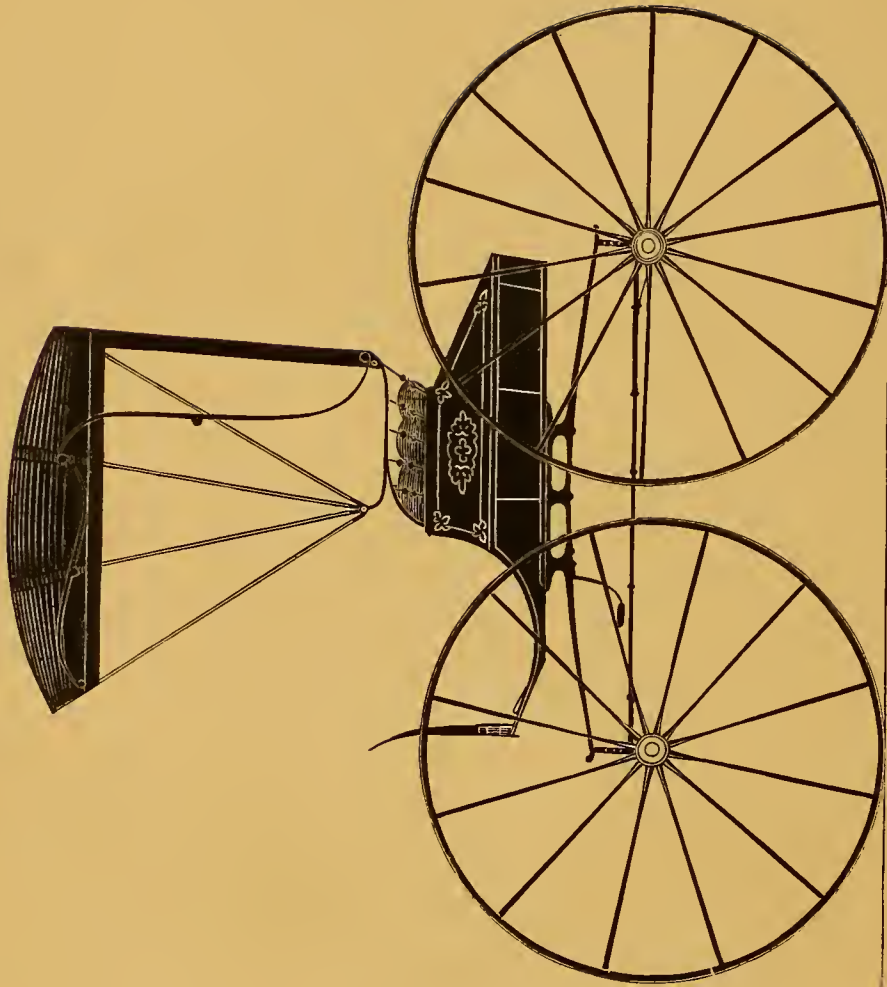

THE SIDE-SPRING BUGGY.— $\frac{1}{2}$  IN. SCALE.  
*Engraved expressly for the New York Coach-Maker's Magazine.—Explained on page 70.*



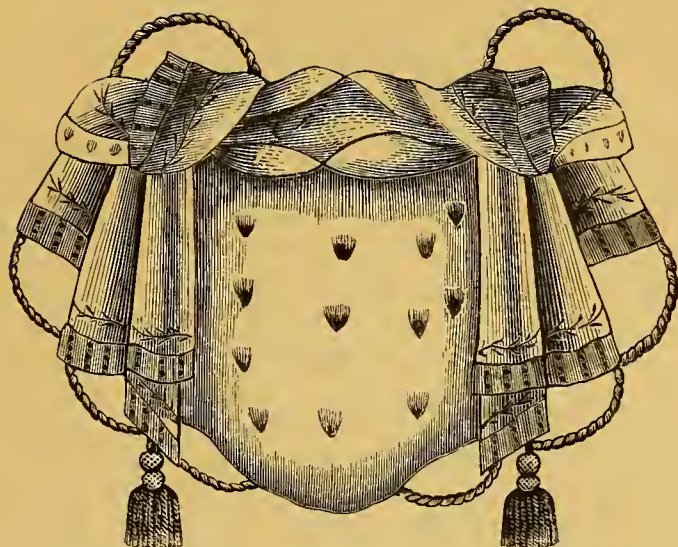

No. 1.



No. 2

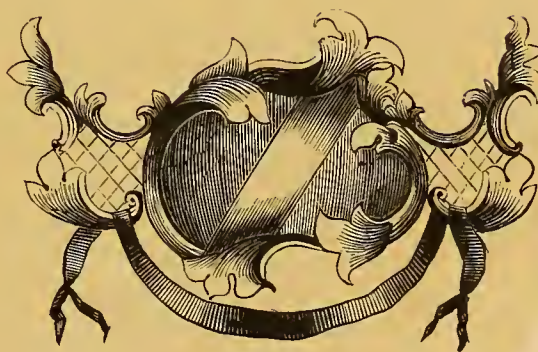

No. 3.

ORIGINAL ORNAMENTAL DESIGNS.

*Engraved expressly for the New York Coach-Maker's Magazine.—Explained on page 71.*





DEVOTED TO THE LITERARY, SOCIAL, AND MECHANICAL INTERESTS OF THE CRAFT.

Vol. II.

NEW YORK, SEPTEMBER, 1859.

No. 4.

### Miscellaneous Literature.

For the New York Coach-maker's Magazine.

#### HOW CARRIAGE-MAKERS ARE MADE OUT WEST.

BY GEO. P. TINKER, OF INDIANA.

It has often been asked, What is the reason that carriages made in the country and country towns, are not as finely manufactured in every particular, as those got up in large cities? I will answer the above question by giving you the mode of making workmen, and the manner in which carriage-making is generally conducted throughout the country.

The first which I shall attempt to describe are those *men* who have practised at making lumber-wagons, wheel-barrows, ploughs, harrows, and all the other implements that are used by the farmer, who after two, and sometimes after one year's apprenticeship, a boy becomes a master-workman. During his apprenticeship he has repaired several buggies and has made the wood-work of one or two new ones; he therefore *is* a finished workman. His time being out, we find him starting a shop for himself, or "tramping" to some neighboring shop in quest of a job. *So you see at once he is a fit subject for undertaking a good job.*

The next and most efficient of this kind of carriage-makers are the sons of wagon-makers, or common blacksmiths, who from their infancy were about a shop, and who being of an ingenious turn, and charmed by the attractive appearance of every nice carriage they saw, it has created a taste for the business, and so strong, that with untiring perseverance, they overcome every obstacle in the course of their labors.

The third are a class of carpenters and cabinet-makers, who are such botches at their own trades, that they cannot do a passable job, so they take up the business of carriage-making, and of all the carriage-makers in the world, these last are the worst. I once saw a buggy made by one of *these workmen*: one of the hind wheels had fifteen spokes in it and the other thirteen. Another which I heard of, in making a body, split seven dash-panels and then gave a body-maker seventy-five cents to warp and put it on, after it was planed up. These last workmen commence carriage-

making after they have been married for some time, and are between twenty-five and forty years of age: their career is generally brief.

I will now give you a short sketch of the process of getting up a job. We will go back ten or fifteen years as a starting-point. At a cross-roads, or on a little farm, we find the wood-workmen's little old shop, which was once occupied as a dwelling-house; or if not, it is a little log building about sixteen feet square. Now, if he is advanced in business enough to have one or two workmen, he also has a smith-shop; but if he is "going it alone," he does not bother himself with the smithing business; so a customer gets him to make the wood-work of a buggy, and afterwards takes it to a blacksmith's shop to be ironed. He also furnishes the iron, and then he, or the blacksmith, or the wood-workman, paints the job—most generally the latter. The wood-workman most generally does the trimming! Well, just imagine the vehicle in all its *beautiful* proportions. The axle made of wood and about three inches deep, and arched up; the hind wheels being about four feet six inches high, the front wheels being about three feet two inches. To make the body set level on the spring-bars, the perch-block would have to be six or eight inches deep; the front of the spokes were shaved so sharp, that it was dangerous to grasp one suddenly, for fear of ruining one's hands; the felloes were one inch and a quarter thick by one and three quarters deep; two-inch and a half box; the axles, as before stated, being invariably of wood; the body being a wide flat goods-box; the sides and ends flaring out; the seat being made precisely after the same pattern as the body. This was set upon what was called the grasshopper knee, or irons that would raise the seat at least twenty inches from the floor of the body; it would appear as though the object was to get these jobs as high in the air as possible; the hubs would be seven inches in diameter and about nine in length, and banded with wrought iron bands; also good-sized spoke bands were essential to insure a good stout job; in fact, they were indispensable.

The above is a fair specimen of a first-class buggy made in this country fifteen years ago, and there are "lots" of them used here yet, by the wealthiest residents of our States. The old superannuated wagon-makers will point to one of these jobs and say, "Boys, if you would make work to stand like that job has, it would do to talk," and

we hear the old farmers using the same language, or in a little different way, sometimes saying: "If you could make such work as they used to make, I wouldn't mind getting one made, but these little light quill-wheel things are of no earthly use, they an't worth shed-room." Well, you begin to tell him the nice qualities of a light one-horse buggy, and he will say that "You cannot carry any baggage in them;" you will answer that they are not designed for that purpose, but should you make spring-wagons for that purpose, that are as nicely finished as any buggies, then the old man will say: "If I have a wagon, I will have a farm-wagon at once, and if I have a buggy I'll have a buggy." Now, here is the secret of the whole matter: if that old man could buy a nice buggy for about \$150, he would have one; but to pay from two hundred up to three hundred dollars for a buggy, is more than the old miser thinks he can afford.

We come along down a little further, and we see stick-seats, brass bands, bent shafts and bent rims, all of which met with opposition from the wise carriage-makers, because to make a good stick-seat was at least three days' work, and then it was not half as strong as a box one. As for bent shafts, *they* were raised so high at the back end that they would pull too high on the horse. Bent rims! of all the "bores" in the world, bent rims were the worst. Why, they would crawl out from under the tire, they would split and shiver from one joint to another, and they would also settle between the spokes; and such being the case, the buggy would not ride well at all; yes, and those brass bands! "O pshaw! they will soon get black; and another thing, they an't stout enough to allow the box at the small end to be driven in sufficiently tight to keep it in its proper place. When iron axles first came in use, they met with opposition, on the ground that every sudden jolt they got, they naturally would spring, and would stay sprung. Another grand objection was, there was not sufficient "bosom" in the boxes of an iron axle, to hold the desired quantity of tar. These axles were the last things to come into use, and today there are hundreds of so-called buggies used in the western country, with wooden axles. These are made by those stingy close kind of workmen, who will expend a dollar in trying to make five cents. After stick-seats, bent shafts and rims, brass bands and iron axles, came into general use, the city painting seemed to make more difference in the appearance of a job, than was apparent in the other branches. But as I have extended these remarks too far already, I shall defer the balance for a future number.

#### UNITED STATES PATENT OFFICE—SKETCH OF ITS HISTORY.

To the student in pursuit of knowledge upon any branch of science and invention, there is no museum or collection of material in this country at all to compare with that so beautifully and artistically arranged in the spacious halls and galleries of the Patent Office. Like the other institutions of the Federal Government, the growth of this office has increased with the development of the resources and rapid expansion of the power and population of the Republic. A glance at its history shows that such an establishment early attracted the attention of the wise and able men of the revolutionary era. Hence we find that, on the 10th of April, 1790, Congress passed an act authorizing the Secretary of State, the Secretary of War, and the Attorney-General, or any two of them, to grant patents for such new inventions and discoveries as they should deem sufficiently useful and important. This act, which originated the Pa-

tent Office, was repealed, and a new act passed on the 21st of February, 1793. Under this latter act patents were confined to the citizens of the United States, and they were to be granted by the Secretary of State, subject to the revision of the Attorney-General. By the act of the 17th of April, 1800, the privilege of suing out a patent was extended to aliens of two years' residence in the United States, and the act of July 13, 1832, only required the alien to be a resident at the time of his application for a patent, and to have declared his intention, according to law, to become a citizen. By the act of Congress of July 4, 1836, all former laws on the subject were repealed, and the patent system was reënacted with important improvements, embodying a new organization of the office, and conferring upon it much more extensive powers than it had heretofore possessed. Under this act the establishment was organized essentially as it exists at this day, except that by subsequent acts the power of appeal was allowed from the decision of the Commissioner to either of the Judges of the Circuit Court of the District of Columbia. The Patent Office occupied a part of the General Post-office building, which was destroyed by fire on the 15th of December, 1836. All its invaluable contents were lost by this sad accident; and by the act of 3d of March, 1837, Congress provided for the recording anew of patents and assignments of patents recorded prior to the date of the conflagration, and for issuing new patents for those destroyed. The officers of the Patent Office were also directed to procure duplicates of the most interesting models destroyed, at an expense not exceeding \$100,000. The loss of the Patent Office, or rather of its contents, caused a deep sensation throughout the country, and universal regret was expressed on all hands at this untoward event. Even the ruthless Admiral Cockburn, who fired the Capitol and President's House, and other public edifices in this city, had spared the Patent Office, and yet accident in a few hours destroyed the labors of many men for many years, which even that modern barbarian feared to touch.

This sketch of the legislation of Congress on the subject of patents, familiar as it is to the professional man, may give to the general reader an idea of the early and continuous importance attached by the law-makers to this important branch of the Government. Growing out of, and forming as it were an integral portion of the patent system, is what may be termed the patent law branch of our jurisprudence. The minds of the most eminent of our jurists, both on the bench and at the bar, have been taxed to the utmost by the intricacy and subtlety of the investigations of many cases which have arisen and been adjudicated upon under these laws. A legal writer justly terms the patent-law branch of our jurisprudence "the metaphysics of the law." And so it must continue to be and to increase, because of the increasing spirit of improvement in agriculture and manufactures and machinery, both here and in Europe. The Patent Office is essentially a national institution in every sense of the word, and will always remain so, inasmuch as it would be impracticable for the States separately to make provision for the effectual protection of the rights secured to inventors under the patent laws.

All parties concerned in patents, whether as inventors or users of the machines for which they are granted, are fully aware of the importance of the faithful execution and enforcement of the patent laws; and there is no class of cases tried in our courts in which the community generally take more interest.

In all countries and in all ages, inventors or discoverers of any new agent or implement useful to man in his varied pursuits, have been considered as among the most valuable citizens of the State, and deserving of its encouragement and protection. Of late years this appreciation of such men seems greatly to have increased, both in the United States and in Europe. We trust that it will ever be so, and that worth and merit, in whatever walk of life it may develop itself, may always meet with recompense and reward.—*Constitution.*

#### DISTANCE AND FARE INDICATOR.

THIS invention of Robert Clegg, of Islington, England, consists in attaching to, or connecting with vehicles, machines, or parts of machines, or other objects, which, or parts of which, rotate or otherwise move certain apparatus or contrivances arranged and made to operate essentially as follows: The patentee affixes to, or forms upon, an axle or other rotating part of a machine, vehicle, or other object, a pin, stud, or other equivalent contrivance, and upon a non-rotating part of such vehicle, machine, or other object, is centred a lever, one extremity of which lies within the range of such pin, stud, or other equivalent contrivance, as it rotates, and receives an intermittent motion therefrom. To the other end of the said lever, a short spring, lever arm, or other contrivance, is attached in such a manner that, when the first named lever is moved, it shall impart a corresponding motion to the ratchet wheel, against which the said spring, lever arm, or other contrivance, is pressed. With this ratchet wheel is combined another wheel or other wheels, which transmit motion intermittently to a hand or hands moving in front of a suitable dial or dials.

Each time the part which carries the pin, stud, or other contrivance rotates, the lever and its appendages move the ratchet wheel round one tooth, and when the ratchet wheel has thus been moved through a distance corresponding to any given number of its teeth, it moves the adjacent wheel round one tooth, and this wheel either carries the hand round with it, or moves a third wheel which does so, or a third wheel and other wheels which do so. It is manifest, that by properly forming and adjusting the wheels, the hand may be made to move at any required intervals, and thus register or indicate fares, the distances passed over by vehicles, the revolutions of machines or parts of machines, and other similar quantities. The subjoined engraving is a view of the interior of the apparatus, with the dial and front plate removed. Upon the nave of the wheel is fixed at an angle, a jointed stud or pin, which is composed of two parts, connected by a pin, and furnished with a spring which, after the two parts have been folded together, presses them open again. The apparatus is attached, by any convenient means, to the body or other non-rotating part of the vehi-

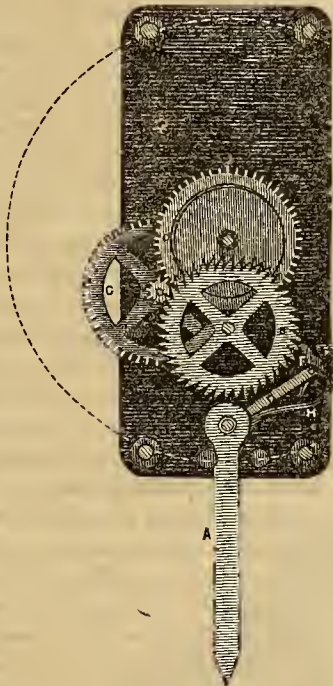

cle, and in such a position that as the nave revolves, one part of the stud comes against the end of the lever, A, and moves it in the direction of the arrow. This lever, A, moves about a pin, and carries at its upper end a short inclined arm, to which is pinned a pallet, F, which is pressed by a spring into the teeth of a toothed wheel, B, mounted upon a suitable axis or arbor. Upon the axis of the wheel, B, is a pinion, which gears into a toothed wheel, C. The axis of this wheel carries a second pinion, which gears into a toothed wheel, D, and the axis of this last wheel has pinned upon it a finger or pointer on the outside of the dial face. On the side of the wheel, B, opposite to that on which the pallet, F, is, a second pallet, attached to a spring, is applied, and when the lever, A, is moved, the two pallets drive the various wheels and pinions, after the manner of ordinary clock-work. The teeth of the wheels and pinions are so arranged and combined, as to the number and position, that while the vehicle is traveling one mile, the finger or pointer moves round from one of the figures upon the dial to the next figure, the figures upon the dial being arranged to indicate both fares and distances. Any code of fares may, of course, be employed, according to the place or service in which the vehicle may be employed. The object of jointing the stud or pin on the nave of the wheel, is, that when the vehicle is backed, one part may yield on touching the lever, A, and pass it without moving it. A spring, H, is applied to force the lever, A, back to its first position after it has been moved by the stud. An apparatus of the foregoing, or any equivalent or similar description, may be so arranged that the driver or other person may set it anew at each journey, or so that it shall be inaccessible to him, and under the control of the owner or other person in charge of the vehicle; or one of each kind may be applied, if desired, to the same vehicle.—*Practical Mechanic's Journal.*

#### COACH-MAKING HISTORICALLY CONSIDERED AND INCIDENTALLY ILLUSTRATED.

BY THE EDITOR.

#### CHAPTER XVI.

The "Lover of his Country's" arguments continued—Stage-coach travelling in the seventeenth century—Its difficulties illustrated by cotemporary authors—The cost of "a little chariot" in 1681—The carriage of Peter the Great described—The Tatler's proposed tax on vehicles—A Frenchman's description of travelling in England in the 18th century—Mrs. Manley on stage-coaching—Another side to the stage-coach question, by those in favor of them.

But it was not only the citizens of London whom the "Lover of his Country" thought injured by the introduction of stage-coaches and caravans, for he complains that by journeying in these vehicles through the country, "the consumption" of provisions was hindered. To illustrate this he says: "A coach with four horses carries six passengers; a caravan with four or five horses carries twenty or twenty-five; these, when they come to their inn, club together for a dish or two of meat, and having no servants with them, spend not above 12d. or 16d. apiece at a place; yet perhaps foul four, five, or six pair of sheets."

The following passage illustrates the speed of travel and the cost thereof, in stage-coaches in 1673: "Men do not travel in these coaches with less expense of money or of time, than on horseback, for on horseback they may travel faster; and if they please, all things duly considered, with as little if not less charges. For instance, from London to

Exeter, Chester, or York, you pay 40s. apiece in summer, and 45s. in winter, for your passage, and as much from those places back to London; besides, in the journey they change coachmen four times, and there are few passengers but give 12d. to each coachman at the end of his stage, which comes to 8s. backward and forward, and at least 3s. comes to each passenger's share to pay for the coachman's drink on the road; so that in the summer the passage backward and forward to either of these places, cost £4 11s., and in winter £5 1s., and this only for *eight days' ride in summer, and twelve in the winter.*" Our author allows five days for the same journey on horseback, and thinks this mode of travel "much superior, even in point of convenience, to riding in stage-coaches."

Continuing the thread of his argument, he asks "What advantage it can be to a man's health to be called out of bed into one of these coaches, an hour or two before day in the morning, to be hurried in them from place to place till one, two, or three hours within night; insomuch that, after sitting all day in the summer-time, stifled with heat and choked with dust; or, in the winter-time, starving, or freezing with cold, or choked with filthy fogs, they are often brought into their inns by torch-light, when it is too late to sit up to get a supper, and next morning they are forced into a coach so early that they can get no breakfast? What addition is it to men's health or business, to ride all day with strangers, oftentimes sick, ancient, diseased persons, or young children crying; all whose humors he is obliged to put up with, and is often poisoned with their nasty scents, and crippled with the crowd of boxes and bundles? Is it for a man's health to be *laid fast in the foul ways, and forced to wade up to the knees in mire, afterwards sit in the cold till teams of horses can be sent to pull the coach out?* Is it for their health to travel in rotten coaches, and to have their tackle, or perch, or axle-tree broken, and then to wait three or four hours (sometimes half the day), and afterwards to travel all night to make good their stage?"

"The Lover of his Country" tells us, that if the rich have occasion to travel, they may "ride in the long wagon-coaches, *which are those that were first set up, and are not now opposed,* as they do little or no hurt. Gentlemen may keep coaches of their own, or ride on horseback." And as for the poor, they should not be encouraged in pride and extravagancy, or allowed to ride with gentlemen; or like persons of quality, in a coach with four or six horses. What effect this defective reasoning had upon the public, may be inferred perhaps, from the letter of a son to his father, written in 1673: "Honored father, my dutie premised, &c. I got to London on Saturday last, my journey was noe ways pleasant, being forced to ride in the boote all the way. Ye company yt came up with mee were persons of great quality, as knights and ladies. My journey's expense was 30s. This travel has soe indisposed mee, yt I am resolved never to ride up again in ye coach." Such was the state of the roads at this time, that when Charles the Third of Spain visited England, and Prince George of Denmark went out to meet him, that the peasantry were obliged to bear the carriages on their shoulders, which took six hours to travel the last nine miles of the journey, which, says an attendant, "We had never done, if our good master had not several times lent us a pair of horses out of his own coach, whereby we were enabled to trace out the way for him." When James the Second abdicated the throne, the fact was not known in the Orkneys until *three months* after the

event. Subsequently the Duke of Somerset was accustomed, when he went from London to Petworth, to send a letter beforehand, requesting "the keepers and persons who knew the holes and the sloughs, to come to meet his Grace, with lanthorns and long poles, to help him on his way."

The usual mode of conveyance at this period for the humbler classes, was in long and cumbrous wagons or caravans, when they went from town to town. These were drawn by four and sometimes five horses, carrying from twenty to twenty-five passengers.

The costs of a coach a few years afterwards may be seen from the following entry in Sir William Dugdale's *Diary*: "1681. Paid to Mr. Meares, a coach-maker in St. Martin's-lane, for a little chariot, which I then sent into the countie, £23 13s. 0d. [about \$105], and for a cover of canvas, £1; also, for harness for two horses, £4."

Abroad, but little progress in coach-making appears to have been made. In a curious collection at St. Petersburg, now in the possession of the royal family, and originally belonging to Peter the Great, some specimens of antique carriages are still preserved. One is close, made of deal, stained black, mounted on four wheels, the windows of mica instead of glass, and the frames of common tin; the other is open, with a small machine behind of Peter's own invention—its purpose to determine the number of miles traversed on a journey. In the same collection is the litter of Charles XII., used at the battle of Pultowa.

In the *Tattler*, No. 144, for March 11th, 1709, occurs the following passage: "The horses and slaves of the rich take up the whole street; while the peripatetics are very glad to watch an opportunity to whisk cross a passage, very thankful that we are not run over for interrupting the machine that carries in it a person neither more handsome, wise, nor valiant, than the meanest of us. For this reason, were I to propose a tax, it should certainly be upon coaches and chairs: for no man living can assign a reason, why one man should have half a street to carry him at his ease, and perhaps only in pursuit of pleasures, when as good a man as himself wants room for his own person to pass upon the most necessary and urgent occasions. Until such an acknowledgment is made to the public, I shall take upon me to vest certain rights in the scavengers of the cities of London and Westminster, to take the horses and servants of all such as do not become, or deserve such distinctions, into their peculiar custody. The offenders themselves I shall allow safe conduct to their places of abode in the carts of said scavengers, but their horses shall be mounted by their footmen, and sent into the service abroad; and I shall take this opportunity, in the first place, to recruit the regiment of my good old friend, the brave and honest Sylvius."

It would seem that it was the fashion at this time to have coats-of-arms emblazoned on the carriage-door. The writer above alluded to, says: "I have given directions to all the coach-makers and coach-painters in town to bring me in lists of their several customers; and doubt not, but with comparing the orders of each man, in the placing his arms on the door of his chariot, as well as the words, devices, and cyphers to be fixed upon them, to make a collection which shall let us into the nature, if not the history of mankind, more usefully than the curiosities of any medalist in Europe."

M. Misson, a Frenchman travelling in England in 1725, says: "They have several ways of traveling in England. The post is under good regulation throughout, and the

horses are better than those of France. There are coaches that go to all the great towns by moderate journeys, and others, which they call *flying coaches*, that will travel twenty leagues a day or more, but these do not go to all places. They have no *messageries de chevaux* as in France; but you may hire horses for what time you please. The sea and the rivers also furnish their respective conveniences for traveling. I say nothing of the wagons, which are great carts covered in, that lumber along, but very heavily. Only a few poor old women make use of this vehicle." The idea of "flying coaches," which only went about four miles an hour, is enough to raise a smile in the countenance of modern travellers.

Mrs. Manley, in her "Stage-coach Journey from London to Exeter," which took five days to travel, including a Sunday in which she rested at Salisbury, lets us into a little knowledge of lurching by the way, which serves to illustrate the customs of that age. She says: "They most unmercifully set us down to dinner, at ten o'clock, upon a great leg of mutton. It is the custom of these dining-stages to prepare one day beef, and another our present fare. It is ready against the coach comes, and, though you should have a perfect antipathy, there is no remedy but fasting. The coachman begs your pardon; he would not stay dressing a dinner for the King (God bless him!) should he travel in his coach."

The complaints of those who clamored against the establishment of stage-coaches, were met by some sensible remarks from the proprietors, afterwards. They agreed that since stage-coaches had been established some years, and continued at great expense and risk, the damages that would accrue to the public, if they were discontinued, would evidently be much greater "than the disadvantages that can be imagined to fall upon any person, should the same be continued; though, withal, were it admitted that all the petitioners were damnified thereby, yet the interests of all conjointly are not to be respected in comparison of the public, nor to be put in the balance with it; \* \* \* that trade, as all others, being only intended for the public, their private profit is not to come in computation with it, for the people are not made to enrich inns or any other trades, but all trades for the benefit and service of the people, and all conjoined together are but as a particular interest in comparison thereof."

It had been charged that the consumption of provisions for man and beast had been lowered and the rents of lands brought down by the introduction of stage-coaches. With this the memorialists did not consider they had any thing to do, and say that "it is either the laying aside the ancient way of hospitality and good housekeeping, or else the poverty of the country, and not the *hackney-coaches* [meaning stage-coaches], that hinders the consumption thereof." From reading the above, we find, as in the case of almost every other useful innovation, the introduction of stage-coaches and other vehicles calculated to facilitate travel, met with strong opposition from a class, whose personal interests they imagined would be affected thereby. But the lesson which the subject teaches, is one well calculated to discourage hereafter all like opposition to any thing calculated to benefit mankind.

For the New York Coach-Maker's Magazine.

A MORNING INVITATION.

THE golden-tinted east,  
Where comes the king of day,  
Brighter and brighter shines  
With his enlivening ray;  
For, lo! Aurora, hero of the hour,  
Drives forth her chariot from a shady bower!

Lo! springing upward, see  
The prancing steeds of light  
And glorious Hours arrayed  
In gorgeous vestments bright:  
Will mortals sleep at such an hour,  
And waste in slumber health and power?

Nature invites to rise,  
She loudly greets the ear—  
Up! up! and snuff the air,  
So pure, so sweet, so clear—  
The burdened fields of ripening corn  
Are sparkling in the dewy morn!

The extended landscape see,  
All strewn with glassy pearls,  
And hear the warbler's song,  
As o'er our head he whirls:  
'Tis morn—of life the richest dower—  
Will mortals dream at such an hour?

S.

For the New York Coach-maker's Magazine.

GEOMETRY OF CARRIAGE ARCHITECTURE.

BY A PRACTICAL COACH-MAKER.

PART SIXTH—BODY CONSTRUCTION.

(Continued from page 46.)

DIAGRAM No. 4 shows the manner of framing the other parts not heretofore explained. To obtain the side swell correctly, you must refer to the square rule in vol. 1, at page 107, where you will get the desired information

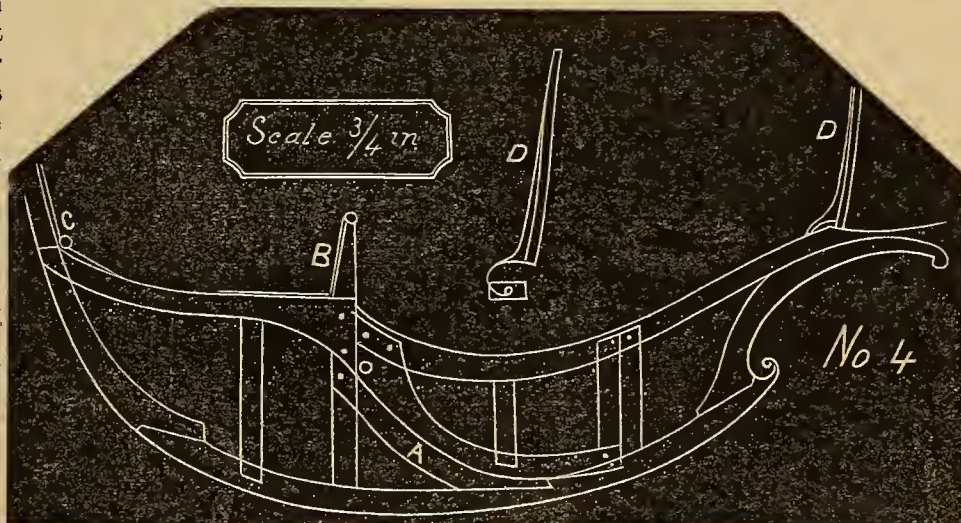

respecting the framing of pillars, &c. The swept piece *A* must be cut into the bottom-side and halved into the pillar, immediately under the back arm. Allowances must be made for the door-rabbit. The lead moulding on the door will be sufficient to form the sweep without working a moulding on *A*. The door should be made of three pieces and a strainer. The iron, *B*, which receives the slats for the top, can be made to take the arm; it will strengthen

the job very much; also the back-prop iron *C*, can be made a corner-iron, to keep the back from getting apart. The flap *D*, or water-deck lid, is here represented with concealed hinges. The advantages derived from these kind of hinges is that they are out of sight when the lid is down, and the lid stands up without any additional support or catch. There is sometimes a great deal of trouble in getting them right, and much depends on the sort of a job they go on, as they require room to drop. The frame of the lid should drop into a rabbet in the front arm *E*, so as not to be seen. Then the top panel comes over to the outside, and forms a bead, and throws off the wet.

It would be well here to make a few remarks as regards paneling. Some mechanics wet and steam their panels unnecessarily, which is wrong. Panels should be put in as dry as possible. How often will you see a back-panel spoiled by caving in. There is the secret: the panel is either green when it is put in, or it has been steamed until it has swollen, and then been put in wet. Then it has to dry and shrink, consequently it has to cave in somewhere. The same is the way with quarter-panels and doors. If they are swelled going in, they must split, for they cannot cave in on account of the strainers.

Just before putting in your panels, heat them at the stove; then wet them on the outside with your sponge; this will be all-sufficient. When you are ready to bend your back-panel, try and see if it will warp first without wetting. If there is any moisture in it, it will; and it ought to be driven out; if not, wet it very little on the outside. Another procedure very often splits the panels, and that is wedging them in, which is very foolish; for if there is the least lump in the moulding either side of the wedge, pop goes the panel. Although you may not see it at first, it will show when the body is varnished. Let your panels fill the groove, and there will be no necessity for wedging.

(To be continued.)

For the New York Coach-maker's Magazine.

## ARE YOU AN HONEST MAN?

BY S. E. TODD, ESQ.

"An honest man is the noblest work of God."

AFTER the benevolent Creator had spoken, and at His word Earth sprang from the womb of nonentity—when He had sent forth His regal mandate, that she should not be moved, and every particle of matter, in obedience, stood fast—when he had commanded the mellow light to dispel the impenetrable gloom and midnight darkness that moved upon the face of chaos, and the obedient light had darted from the orient chambers, and irradiated all nature with the glory of a summer's morning—when He had spread out the starry firmament in all its splendor and magnificence, and clothed the fertile vale with beauty, and the hills and mountains with grandeur, and brought into existence teeming millions of creatures, with their beauty or homeliness, with their utility or apparent worthlessness, He formed an image from plastic clay, and gave it a form and beauty of figure, which was, and now is, a becoming habitation for one after His own likeness. In addition to those noble faculties with which man was first endowed, the Creator implanted in his breast principles of the strictest *honesty* and *integrity*. With honesty to shield him and integrity to guide him, he stood forth among the magnificent works and wonders which attest the Creator's greatness, as the most noble work

in the entire universe. All animate creation, throughout the wide domain of their Maker, revered, and stood in awe of him, who bears the image of the great First Cause. Angelic choristers struck up their most tuneful notes—seraphs and glorified spirits tuned their harps anew, and the feathered songsters of the grove warbled in richest melody, and joined in one universal jubilation, that "*an honest man*," the most stupendous work of creation, stood pre-eminently the highest among every thing useful and beautiful, which the Creator admired, and pronounced "very good."

We all respect and love an honest man. Every one feels an inward conviction of approbation, when he meets with one who gives us all the assurance, that in all his intercourse and dealings with his fellow-men, he is actuated by principles of the strictest integrity, in thought, word, and in actions. The veriest knave in civilized society respects an honest man, inwardly, on account of his honesty, and often feels in his reflecting moments—if he ever allows himself to reflect—that a man who can face undaunted every one with whom he has associated, in the walks and business affairs of life, without bearing the reproach of dishonesty, that he is truly a man of exalted moral excellence.

On the contrary, we all despise dishonesty, and dishonest principles; and we disesteem and are wont to shun him who is the dupe of such debasing principles as prompt one man to defraud his fellows, even in the smallest matters. We cannot view with any complacency or approbation the character of him who knowingly appropriates to his own purpose, intentionally or through mistake, any thing to which he has no just right; and every one will condemn the principle which actuates one man to lie, prevaricate, or deceive another in any way, and thus obtain of him, in an unfair manner, any thing which would have been beyond his reach, had honesty prompted to action.

"Honesty is always the best policy." So said our fathers; and their ancestors were taught the same noble principle, by their progenitors. Wise men and great philosophers in all ages have taught that honesty is not only the *best*, but far the *wisest* policy. It cannot be denied that that policy is good and wise, which will enable a man to pass through all the temptations connected with the business of his whole life, and when he comes to close up his mortal career, to be able to say, *I am an honest man*. Who can tell what peaceful hours such a man enjoys, when in his sober and reflecting moments, he remembers that he has wronged no man, nor defrauded any? Strict honesty is a most agreeable source of happiness in every stage of our existence. Happy is that man who can look back to the days of his youth, and the years of riper age, and have the inward satisfaction that his whole life, up to his declining days, or to a good old age, has been that of an honest man. If we could measure the years of a strictly honest man, by his peace of mind, and uninterrupted flow of happiness, the number would often be augmented to that which express the age of him who saw more days than any other mortal (Gen. v. 27), when properly contrasted with the unhappy years of him who has all his life long disregarded the principles of honesty, and been actuated by a motive which has destroyed all his comfort, and embittered his whole life with the upbraidings of a guilty conscience. It is impossible for a dishonest man to be a happy man. How can a man say, "I am a happy man," when the memory of past actions rises up, and often recurs to him, in his hours of the greatest enjoyment, and accuses him of dishonest thoughts, dishonest motives



and actions, which wronged and oppressed the needy and the destitute, and made him no wiser, nor better, nor useful to the world, nor more respected in the circle of society, where he is accustomed to move?

"Honesty is the best policy," because a strictly and scrupulously honest man, in thought, word, and actions, seldom or never sustains any pecuniary losses. This idea, at first thought, seems to be a sweeping assertion. But I have not penned it as a thought of the moment. Perhaps no one thought on any subject of morality, has been more thoroughly canvassed and seriously investigated, than this. We know that there have been numerous instances, when those who sustained an irreproachable reputation for strict honesty, have sustained pecuniary losses, when they seemed to be making the best possible use of their property, which rendered them wholly insolvent. Now then, the question arises, "*Were they strictly honest men?*" Unfold the tablet of the heart, and see if no dishonest actions or words loom up, during their whole career, and scrutinize closely every motion and purpose, and see if you do not meet, somewhere, with desires and purposes strengthened by a determination to secure this or that object, which the conscience of every honest man would denounce as deliberate dishonesty.

Honesty is the best and wisest policy, because a person who is and always has been an honest man, in thought, word, and deed, will be above that suspicion which often rests upon many who would have every body think they are honest, when in truth, there is very little honesty about them. It cannot be expected that a person will be above reproach, who cherishes dishonest thoughts, although he may not be guilty of any act of dishonesty which is known to those about him. We often suspect a man's honesty or dishonesty, although we are not able to assign any plausible reason *why* we think so. And we often feel unwilling to confide in such individuals, although they may have seemed to be always scrupulously honest. On the contrary, we often have thoughts respecting others, that they are *honest*, and that we are not in the least afraid to confide in them. The truth is, a person in this respect is usually thought of as he truly is. If he is truly honest, as a general rule the universal voice will be, I believe he is an honest man; while he who most ardently desires to be called an honest man, and to have no one think that he was ever guilty of a dishonest action, when such is not really the case, need not wonder, if he is reproached as being not scrupulously honest. It is folly to expect that every body will speak of us as being honest, and *think* of us as those whom no one need fear to confide in, when we cannot stand up in any place, and before every body in the world, and truthfully declare, *I am an honest man.*

## The Home Circle.

For the New York Coach-Maker's Magazine.

### MARY BLOOMFIELD'S NEW CALICO DRESS.

BY J. PAYNE LOWE, OF NEW YORK.

DRYGOODS merchants and drygoods clerks know very well that little is done in the stores of Broadway, or other fashionable streets in New York, on rainy days. Now and then, perhaps, some daughter of the Emerald Isle, who has her work "*done up*," secures the opportunity of going

*out*, when her mistress is inclined to stop *in*, a most favorable time for making purchases in Broadway. This was Mary Bloomfield's case, who was as frolicsome, good-natured, good-looking, and as honest an Irish girl as ever stood in shoe-leather, danced at a "cross-roads," or tripped over the green fields of old Ireland. Mary was accompanied by another darling from the "*ould dart*," who was on the same business as herself, but who, unlike Mary, had a pair of piercing eyes, which, as some of the "*neighbors*" used to say, "would bore a hole through a pine board;" but of Mary's beautiful blue eyes it was as often said, that "they were not made for the good of her soul." Mary's companion was a "sweet slip;" her name was Catharine, but more familiarly known as *Katty*, and whether it can be said for the good of her character or not, she had a good deal to do with cleansing and purification, for she was not a washer-woman but a washer-girl, that is, here in America, where every "dacent" body is expected to do something. Mary, on the contrary, was a step higher in professional attainments, for she, poor girl, saw better days in the Emerald Isle. When Mary came to America, some good-natured matron took a liking to her, and made her a lady's-maid. Mary and Catharine sauntered along Broadway, and a beautiful day it was, for a shower had fallen and washed the flags clean, and although the rain fell heavily all the morning, the sun, shining on the large crystal-like panes of glass, twinkled like star-light on the water.

"Well, well, Catharine," says she, "what kind of a dress ought I buy?"

"Faith, I don't know, Mary," said the other, "but I suppose you'd want to get somethin' purty and sarvicable."

"Well," says Mary, in rather a serious tone of voice, "it's often I thought, when I was tripping over the daisies in the green fields around Ballinderry lake, what beautiful dresses I'd have in America, with pretty little flowers for patterns, like the ones along the hedges at home. O Catharine! do you remember the little blue-bells, buttercups, and daisies? Dear me! but they were pretty flowers. I'd rather be at home this minute looking at them than walking through Broadway, making a show of myself, just like the best of them, with all their silks and satins. And, then, the birds used to sing so sweet of a summer morning, when I'd be going to milk the cows; and the lambs used to skip and play with light hearts, not all as one as rich as people in this country, that's always thinking of dress and making a show of themselves."

"Musha, what are you ravin' about?" says Katty.

"Oh! a body can't help thinking sometimes of home and them that's in it. Indeed, all my friends mostly are in this country now; but then there's poor Harry O'Rourke. I wonder will he ever come to America. Mary's the bunch of cowslips, blue-bells, buttercups, and daisies he gave me. It's often he used to say to me, when I used to be funning him:

'Smile, if you will, but some heart-strings  
Are closest linked to simplest things;  
And these wild flowers will hold mine fast,  
Till love, and life, and all be past;  
And then the only wish I have,  
Is, that the one who raises  
The turf-sod o'er me, plant my grave  
With buttercups and daisies.'

Harry used to say that it was Eliza Cook that made that verse, and didn't she do it well?"

"Oh! it's of Harry O'Rourke yer thinkin'. Dear knows

who he's givin' posies to now," says Katty. "Any how, let's get the dhress, for you'll be kilt when you go home for be-in' out so long."

"Ah!" says Mary, breathing a suppressed sigh, "I wish it was *home*."

No listener could doubt that Mary's thoughts had gone over the sea to "her own, her native land."

"Stop," says Mary, "we'll go in here, there's something telling me, and I don't know what it is, that this is the place to buy the dress."

They went into the store, and were shown by the shop-walker to the calico department, when a long "gad of a fellow" stepped up, whom Katty eyed with piercing scrutiny. She had always the use of her tongue when she met with the right subject.

"Ladies, take a seat right there," said he, pointing to the seats alongside the counter, and then continued:

"This is a wet day, an't it?"

"Yis, it is," says Katty, "but what need *you* fret, when you're not out in id?"

The salesman had despair and delight blended in his countenance. The remembrance of many lost sales doubtless sprung up in his mind, but his face was bright with the hope that his present customers would make a purchase. He was a man whose thoughts had no connection, and he had no method in his conversation. His own sayings were constantly contradicting each other, or, as Catharine expressed herself, one end of his tongue made a liar of the other. His complexion was dark, visage long, features sharp, and as Katty said, he was as "fat as a lightning rod, about as tall, and as near heaven as he was ever likely to get." His skin was "tuff," and poor Katty, who was never at a loss for any thing to say, remarked that "it was drawn as tight over his bones as the head of a drum." Katty continued the subject of wet weather, began by Mr. Hardscrabble, by saying: "Sorra a much harm a shower of rain 'id do you; sure it 'id run av your hide like water av a duck's back, and thin iv you got a little bleachin' in this sunny counthree, so as to lighten the color of your complexion a bit, you'd be a beauty athout paint."

"Yes, yes, I guess I would," says Mr. Hardscrabble.

Katty immediately resumed:

"Dear me, iv you wor only put out in a good shower, and thin well dried, and got a good shake, the rattlin' iv your bones 'id make beautiful musie for your soul on its way to glory. Not a bit of scarcity there 'id be for ling as long as the likes av you 'id be in the market."

"Yes, yes, I guess so," says Mr. Hardscrabble, who was so polite as not to disagree with the opinions of customers. "An't you going to buy something nice to-day, ladies," says he in the most affable manner.

"Well, in troth," says Katty, "we didn't come here to stale any thing from ye. Show us down some of them calicoes avick. Take down something purty now."

A whole shelfful of goods were immediately placed on the counter.

"These is very purty things, an't they," says Mr. Hardscrabble.

"Well, they have nothin' to spare no more than ourselves. There's one that's not much to brag of," says Katty, taking hold of the first.

"Well, no, that an't quite so nice as some of the others, I don't think," says Mr. Hardscrabble.

"But here's one," says Katty; "will this wash?"

"Yes, I guess it will," says Mr. Hardscrabble.

"De ye mane," says Katty, "the colors 'id wash out?"

"No, no, the colors is real fast," was the reply.

"I suppose," says Katty, "that nothin' i'd catch them iv they got near wather."

"These an't going to fade. No, ma'am. I guess they an't."

"Oh! ye mane they'll wash out," says Katty. "Sure now, you might as well tell me ye seen a white blackbird as to persuade me you're trying to tell the truth. Iv ye be larnin' to tell lies that way, won't the ould boy have a nice armful of ye some fine day? Did ye think I wouldn't know what 'id wash after I spending many a long day doin' nothin' else? Now, may I ax you 'iv you're an Irishman?" says Katty.

"No, no, I guess I an't," says Mr. Hardscrabble.

"No, thanks be to Heaven," says Katty, "for I wouldn't like to have to deny my country."

"Well, good by," says she, taking rather an unexpected leave of her new acquaintance.

Mary during this conversation had no chance to take any part in the proceedings.

"Then you an't going to buy no dress to-day?" says Mr. Hardscrabble.

"No, I guess I an't," says Katty.

And her companion and she left, and were passing towards the door, when an active young man, whose countenance beamed with intelligence, and whose heart was light as mountain air, said: "Good morning, girls."

"Good morning, kindly," says Katty.

"You had better take a seat for a few moments," said the young man, "until the shower is over."

Katty unhesitatingly seated herself at once, and interrogated her new acquaintance thus: "What counthree boy are you, avick?"

"I'm an Irishman," was the prompt reply.

"Are you long in this counthree," says Katty.

"A few years," says he, adding: "I believe you have been buying a dress."

"Oh! the sorra a one. That long-legged thief that I was talkin' to, wouldn't as much as give us a pattern to see iv the goods 'id wash."

"Oh! come back and I'll give you plenty," says he. They did so, and he very liberally gave patterns, but happened to remark of one piece of goods that it would not wash.

"Oh! by all that's lovely, that's the very one that lain fellow said 'id wash; but, sure, I knew by his countenance that he was a rogue. We'll buy a dress av you, bekase your honest, iv you have a brown the same pattern as that little white and blue. Just think, now, when the blue of that 'id be put in the wather and washed out, where would the pattern be?"

There were twenty-one yards in the piece. Katty took eleven and Mary ten. The former was a little the tallest, and wanted more than Mary, and she said that she would take the biggest and best half, and she had a good example for doing so: "For He that made heaven and earth, kept the best part to Himself."

"What part of the ould counthree are you from, if it's not too bould a question?" says Katty, while the young salesman was putting up the parcel.

"Just before I came here, I lived within a few miles of Philip-town, Kings county, in a place called Ballyowen."

"Oh! that's my own part of the counthree," says Katty. "Did you know so and so \* \* \* \*"

and immediately

they were friends, whereupon an invitation was given him to come where she "lived out," to read a letter from Ireland telling all about the neighbors. The invitation was accepted, and a visit paid the following Tuesday evening. When he came to the house, the first remark, after a cordial shake-hands, was: "I forgot to ax you where you lived afore you wor in Ballyowen."

"I was bred and born near Ballinderry Lake, in the County Westmeath."

"Oh! sure that's where that young girl lived that was wud me the day I was buyin' the dress, and be the same token she's the nicest girl in America, and iv you go across the way and tell her I sint you over, she'll be as glad to see you as angel out of heaven; for she's always talkin' of home."

Our young hero found his way to where Mary was living, and said he was anxious to speak to her about a friend who lived in her part of Ireland. Mary, overwhelmed to think any person could sympathize with her, was delighted to see him. But who could have thought that he was going to ask any thing about Harry O'Rourke? And this subject to her, was sad yet pleasant. "It is now," said our hero, "ten years since I was in Ireland." "And about two months longer since I was there," said she, "and when I was coming to this country I promised to write to poor Harry, and did so, but I never got an answer. I wrote many letters since, but he must have left Ireland or died, poor fellow, for I have not heard from him. Many an anxious thought I do send to old Ireland. I do be thinking of the green fields, the white-thorn hedges, cowslips, buttercups, and daisies, and I often think of Harry O'Rourke, too." All this time she had not dared to look straight at the stranger; her modesty caused her to blush rather than look at him. "The last thing poor Harry gave me," said she, "when I was coming to America, was a bunch of flowers, which withered long ago, but I have them yet, and I could show them to you now." The stranger asked for one, but she said No; they were the parting gift of Harry O'Rourke. The flowers were found in a moment, and she sat beside the welcome stranger while she took them out of a little glass case. He said:

"Smile, if you will, but some heart-strings  
Are closest linked to simplest things;  
And these wild flowers will hold mine fast,  
Till love, and life, and all be past;  
And then the only wish I have,  
Is, that the one who raises  
The turf-sod o'er me, plant my grave  
With buttercups and daisies."

For a moment she turned her head aside, so that falling tears might pay a tribute to affection, for these lines were treasured in her memory. Quick as thought she glanced at the stranger; and though time had wrought many a change on him, she found herself seated beside her own Harry O'Rourke.

#### IMPROVEMENT IN MAKING CAST STEEL.

A PROCESS has lately been invented in London by which cast-steel may be made from iron at a single operation. The inventor uses earthy materials in the state of oxyds or salts, placing them in the crucible in which the iron is placed, to be both cemented and melted into cast-steel. The improvements in this branch of manufacturing are truly wonderful.

For the New York Coach-maker's Magazine.

#### THE STARS SHINE ON.

A MAIDEN fair looks out on a sky,  
Whose stars are more dim than her beaming eye;  
She thinks of the blessings which make life bright,  
And numbers them all by the stars of night:  
And the stars shine on.

A bold, brave youth looks out on the sky,  
His hopes are bright and his aims are high;  
He looks through the veil o'er the future drawn,  
Through a starry night to a splendid dawn:  
And the stars shine bright.

A woman pale looks out on the sky,  
With an aching heart and a brimming eye;  
Her treasures, many as stars of heaven,  
Have one by one from her grasp been riven:  
And the stars shine on.

A care-worn man looks out to see  
If the skies are bright as they used to be,  
When only his hope with their light could vie;  
Ah! the hope he trusted, has proved a lie:  
And the stars shine on.

Unchanging they shine on this world of ours,  
On its springing buds and its fading flowers;  
New loves, new hopes in our hearts have birth,  
But perish ere long like the flowers of earth:  
And the stars shine on.

LUA DELINN.

### Pen Illustrations of the Drafts.

For the New York Coach-maker's Magazine.

#### THE PORTLAND SLEIGH.

*Illustrated on Plate XI.*

PORTLAND, ME., July 30, 1859.

MR. EDITOR—*Dear Sir:* Herewith I send you a drawing of a Portland sleigh, built by Messrs. Kimball & Clement of this city, for David Cook, Esq., of New Haven, Conn.

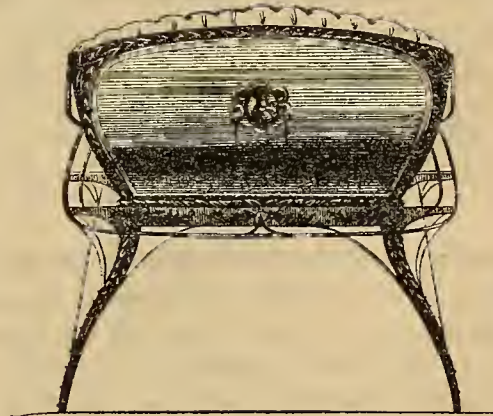

BACK VIEW OF A PORTLAND SLEIGH.

The frame-work of the bottom is of hickory, that of the top of soft ash. The panels of basswood. The mouldings on the top are of hard wood, carved. Shafts bent and made wide, so as to hang outside of runners, on an iron running from front bar to runner, and about eight or nine inches back of the runner, thereby getting the horse back that distance nearer the sleigh than the old way of hanging them. It is trimmed with silk plush, squabbed, brought up and tacked on the top, then a silver moulding instead of lace put on to it.

It has silver-plated handles on the side, a plated rein-rod and foot-rod. All complete, this sleigh cost \$150.

Messrs. K. & C. build some nearly the same style at a much lower figure than that.

Some of their sleighs, without trimming, are sold as low as \$40, and will do good service. They are light and neat, but being made of the best materials, are quite substantial. They employ about 40 men, and build about 150 sleighs and about the same number of carriages, annually, which are mostly sold in New England and New York.

Yours truly, B.

#### FYANS' CALECHE.

*Illustrated on Plate XII.*

WE are indebted to our friend, Mr. Wm. Fyans, of Newark, N. J., for the above draft of a caleche. It has many good points about it, which will be readily seen without our going into detail. In justice to our contributor, we may however state, that the crowd upon our columns in order to give the favors of earlier contributors, has deferred its insertion for some months. We shall endeavor to be more prompt when he favors us again.

#### SIDE-SPRING BUGGY.

*Illustrated on Plate XIII.*

THIS mode of constructing buggies has some advantages which recommend it to a peculiar class of customers. The first is, that they can be made much lighter—a paneled-top one doing good service when weighing no more than 212 lbs., which is the weight of the one from which our draft is drawn. The seat is round-cornered, and in some respects is a modification of the Philadelphia style of finish. A seven-eighths axle, if case-hardened, will be full heavy enough for this vehicle. A three-quarter by one-eighth inch tire, if homogeneous steel, will be the thing.

## Sparks from the Anvil.

#### SHIFTING-TOP BUGGIES.

WE have received the following communication from New Haven, which, as it has an interest to the craft, we willingly give a wider circulation to, with the remark that as far back as the winter of 1849-50, the shifting rail was applied to seats in this city. We trust that those having facts favoring the interests of the Committee, will address the Secretary, as below.

NEW-HAVEN, CONN., August 1, 1859.

Mr. E. M. STRATTON—*Dear Sir*: Several of the Carriage-Makers of New Haven have been sued, and others threatened with suits, for an infringement of an alleged Patent for Shifting Top Buggies, issued in 1851.

At a meeting of the Carriage-Makers of New Haven, the undersigned were appointed a committee to investigate the subject of the Patent, and to take such steps as may be necessary to defend ourselves from what we believe to be a

mere attempt to extort money from us. Any information which you may possess upon the subject we will gladly receive from you, and in the mean time we invite you to join with us in protecting our mutual interests:

Please address the Secretary, H. H. DIKEMAN, *New Haven, Conn.*

DAVID A. BENJAMIN,  
HENRY HALE,  
FREEMAN B. PLUMB,  
WM. A. DOOLITTLE,  
H. H. DIKEMAN, } *Committee.*

#### SCROLL-WORK FOR A COACH.

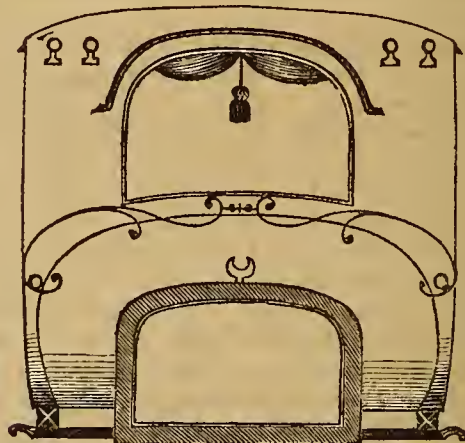

DIAGRAM No. 1 shows the back of a carriage suitable for plate No. 43, Vol. 1. It is furnished with a scroll cross-stay, although scroll-work is not much used on city work. It looks well when neatly got up and plated.

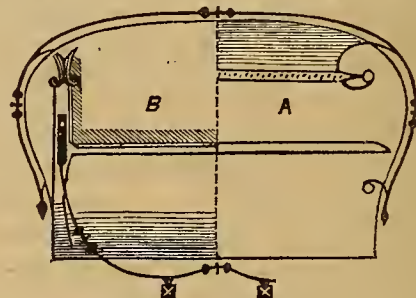

Diagram No. 2 shows the manner of finishing a foot-board, on the same job, top and bottom. Fig. A shows the top, illustrating the heel bar and toe-iron, along with the scroll-stay and handle. B shows the bottom of the foot-board and bracket, with carriage stay and front panel.

#### CASE-HARDENING IRON.

A VERY good paste to be used in case-hardening iron may be had by mixing prussiate of potash with a little water, which applied to the surface, should be permitted to dry, after which it may be inserted in a clear fire, until it assumes a low red color, when it should be taken out and immersed in pure cold water. By this process the surface of the iron is converted into steel. Afterwards it may be burnished with the burnisher, the file marks having previously been removed with emery or some other suitable substance.

## HOW IS CAST STEEL MADE?

MR. EDITOR: *Dear Sir*—Can you favor us with the best mode of making cast steel, now in use, and oblige your subscriber,  
VULCAN.

The following is a patented method recently described in an English publication:

"The patentee puts into a common melting-pot, charcoal bar-iron, clipped in pieces, of about one and a half inches long, and adds thereto good charcoal pig-iron, in the proportion of one part, more or less, by weight of pig-iron, to three parts more or less, of the clipped bar-iron. This combination of metals is melted in the usual manner, and then run into ingot moulds. By this process cast steel is obtained, suitable for any purpose to which cast steel, made on the old plan, can be applied—the various qualities of steel required being obtained by slightly varying the proportions of the bar and pig-iron. Taking 40 pounds weight as the standard of an ingot, from seven to twelve pounds of pig-metal are used, and the remainder is made of bar-iron; these proportions would produce a cast steel suitable for most purposes. Thus, for cast steel to be manufactured into edge tools, ten pounds of pig-metal are added to thirty pounds of bar-iron. For table knives, eight pounds of pig-metal are combined with thirty-two pounds of bar-iron; and for hard steel, twelve pounds of pig-metal are added to twenty-eight pounds of bar-iron. But as almost all irons differ in hardness and quality, these proportions must, to a slight degree, be modified according to the judgment of the melter."

## Paint Room.

For the New York Coach-maker's Magazine.

## ON THE SWEATING OUT OF VARNISH.

THE cause why varnish sweats is easily accounted for. No varnish, however good, will rub well and remain long flattened unless thoroughly dried before it is done, and no varnish will dry when laid over green work, until the paint and color are dry under it. All varnish will sweat out until it becomes dry; therefore the necessity of having each coat dry before the next is laid on. Three coats of varnish, each being well dried before the next is spread on, will dry *hard* one third sooner than three coats laid on rapidly and before the others are dry; for dry it must, and if the under coats are not dry, the whole job is retarded instead of advanced. A body goes into the paint-room, and in nine cases out of ten it *must* be put into the trimmer's hands within a specified time. So the varnish is hurried on, and the different coats rubbed down before they are dry, the natural consequences being that it sweats out. It is unavoidable where such a course is pursued, for the job has not had "fair play." Impossibilities have been attempted, and they have failed, as might have been supposed; for the job has not had the time and sun requisite for producing a good one. In consequence of *abuse*, the varnish is pronounced bad. I say without hesitation, that no varnish, however poor, if dry when rubbed down, will ever sweat out. If poor, it may crack and perish, but will not sweat out. Varnish made of good stock, and properly put on, cannot fail of making a good job. The trouble is in the hurry in some cases where the work is done by the piece at barely living-prices. The painter, in order to make

any thing like fair wages, hurries out his job, consequently slighting his work, and "sweating out" is sure to be the result.

Let us then return to first principles, act consistently, take more time, and as I advised in a former article [on page 53 of this vol.]: On the crawling and shriveling-up of varnish, give the job a little more *sun*, or a little more artificial heat, and in nine cases out of ten the troubles and difficulties that are now in the way, will vanish as the dew before the rays of the morning sun.

OLD FOGY.

[In a note appended to the above, our correspondent says: "If you desire it, I will furnish you for some future number of your valuable Magazine an article 'On the causes why varnish turns white, gray, perishing and becoming smoky and cloudy while standing in the repository.'" Now we have only to say, that if our "Old Fogy" friend will only "do that same," he will not only please and benefit our readers, but shall have the warmest thanks of the editor, who has found more trouble on this score than from any other.—Ed.]

## FRENCH PIGMENTS.

A CORRESPONDENT of the London *Mechanics' Magazine* informs that journal that in the arsenal of Brest, and elsewhere in France, a process is extensively adopted, which consists in the employment of certain salts of zinc, together with the oxyd of the same metal, and a substance designated as a *retarding agent*, as a vehicle or medium for pigments. This retarding agent appears to be borax, or the carbonate of soda, one of which substances is added to the zinc salts in solution, previously to its being mixed with the oxyd. The salts mentioned are the chloride and sulphate of zinc. The proportion of the "retarding agent" is not well ascertained, but the proportion of the salt to the oxyd is that of their chemical equivalents. Although at first sight these facts seem to be, chemically, absurd, yet it is confidently asserted that this compound affords a paint as permanent as oil paint, at a fraction of its cost. This is a valuable discovery; and if we can procure, by the union of chemical substances, colors that will stand the weather without the medium of oil or varnish, it will be a great contribution to our accumulation of facts.

## ORIGINAL ORNAMENTAL DESIGNS.

*Illustrated on Plate XIV.*

THE original designs with which we present our subscribers this month, are from the pencil of Mr. T. R. Sherry, of Newark, New Jersey. Without a word from us in their praise, we have no hesitation in saying that "they will speak for themselves." The designer furnishes the following directions for painting them:

The artist will in the first place prepare a little dry carmine, and mix it up with a little of Noble & Hoare's and some quick drying varnish, so that it may have some gloss remaining on the color, and previous to its becoming entirely dry—it being still in a "tacky" state—blend in with the carmine a little vermilion. These will form the light shades required for the figure.

No. 1. The ground-work for the fringe should be of deep chrome yellow shaded with ivory black. The fringe itself should be formed or striped with Vandyke brown. The inside and ground-work for the upper fringe should be painted with silver white and shaded with Vandyke brown, and the spots should be touched or made with ivory black. The stripe on the upper edge of the fringe should be silver white. The vine should be painted with Antwerp blue, mixed with one fourth silver white. The cord and tassels should be gilded and shaded with asphaltum.

No. 2. The ground-work of the scroll of this figure should be painted with yellow ochre, mixed one fourth part lemon yellow, and shaded with earmine, touching up the ends of the leaves with deep chrome yellow, and the leaf strokes with the same—the netting to be crossed with white and blue. The block on which the vase is placed may be done to represent Egyptian or white marble, as suits the artist—the vase to be gilt, shaded with asphaltum, and the flowers to be in imitation of nature.

No. 3. The scroll of this ornament is to be shaded as above; the bars of the shield to be gilt, shaded with asphaltum on the engraver's dark ground. The ground between the bar and scrolls should be earmine blended with vermilion, and the nettings at each side gilt. The ribbon may be blue blended with white.

## Trimming Room.

### THE BOW-SOCKET OF A GIPSY TOP.

(From a correspondent.)

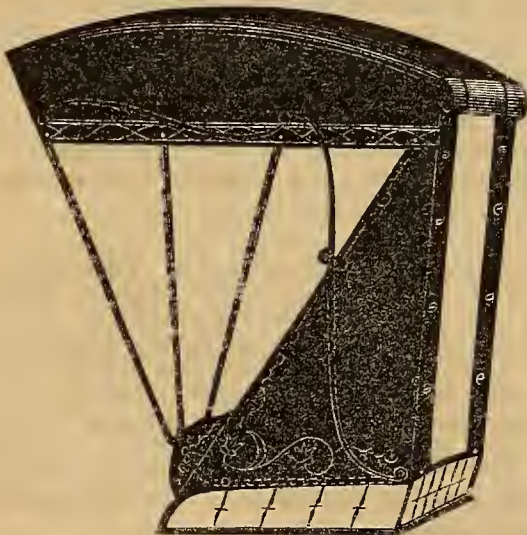

In this Gipsy-top, illustrated above, the sides are secured to the rail by stitching, as indicated by the dotted lines. To accomplish this, a strip of leather is used on the inside, along the inside of the rail. In this case the fancy-shaped bow-socket is made like a common one, and nailed underneath the side portion of the top to the bow. As this top is a protection against mud, it is for some localities preferable.

### LEATHER WASHER CUTTER.

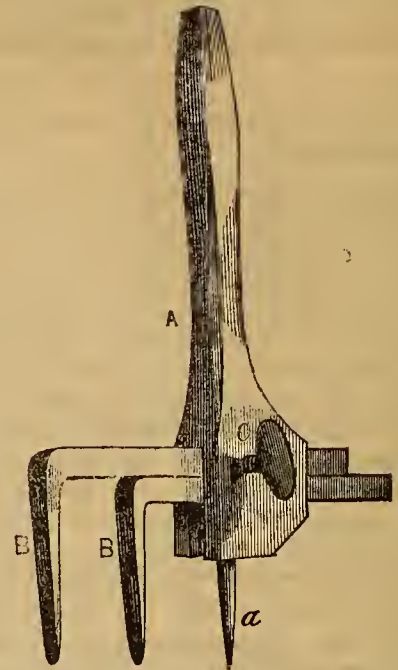

THIS invention of Mr. M. Pennie, of Buffalo, New York, for which a patent has been applied for, is one of the nicest articles for the trimmer we have seen recently, since it can be adjusted to cut any sized washer required.

A represents the bit-stock, of which *a* represents the centre, or pivot which guides the knives BB, and around which they revolve, and which, being movable, may be adjusted to cut any sized washer. Two thumb-serews, one at C, and one on the opposite side, secure these knives in their proper position when adjusted for using. This contrivance supplies a need long felt, and which we hope will prove a source of profit to its inventor.

### BUGGY TRIMMINGS.

FOR light buggies, with dark linings, the cushions are faced on the top with blue cloth, which avoids the complaint made against enameled leather, which is, that it injures the dress, in sitting thereon, while traveling. Another peculiarity is that they are made only one cushion to a seat for two persons, and quite low.

A WORD WITH TRIMMERS.—We are sensible that this department of our Magazine is not all that it might be made, yet when we state that the editor is not himself a trimmer perhaps he may be accorded some credit for having done as well as he has thus far. We have called from time to time upon the trimming fraternity to do something for us, and have offered to pay any reasonable price for good articles. We renew the offer and hope that those who are able will not let our request pass unheeded. Those who are modest about appearing in their proper names before the public, are informed that their wishes will be studied. Come, friends, let us make this department interesting.

## The New York Coach-Maker's Magazine.

SEPTEMBER 1, 1859.

E. M. STRATTON, Editor.

### TO READERS AND CORRESPONDENTS.

**PUBLISHER'S NOTICE.**—As the conductor of this Magazine is determined to make it as useful and interesting as possible, a general invitation is given to all in the different branches of the profession, to contribute to the different departments of the work, such improvements or new features as they may be cognizant of, anywhere in the United States, and when such matter is charged (if used) it will be liberally paid for. We hope that none will be deterred from writing or sending us sketches, under the impression that they cannot write well enough. We take it upon ourselves to properly see to that matter, under the conviction that the purest ore is often found imbedded in the most unsightly rubbish. The craft will much oblige us, if, when patentees call upon them, they would point out to them the superior advantages this work offers for placing their inventions before the craft. In this way much can be done in furthering the objects of this publication.

☞ All letters directed to this office on business, NOT relating to the Magazine, but solely for the writer's benefit, must inclose a stamp; if requiring an answer, two red stamps. Orders for a specimen number must be accompanied with nine three-cent stamps. When these terms are NOT complied with, no attention will be given them.

### TO READERS AND CORRESPONDENTS.

J. H., OF GA.—We cannot take subscriptions to commence in the middle of a volume, and *only* for six months; we prefer to have you commence with the June number, and take the volume for the year.

T. F., OF N. H.—You can have any number of the first volume to complete sets, at 25 cents each. Send postage-stamps.

C. R. R., OF N. J.—You should take no man as *our* authorized agent, except he can supply the back numbers on the spot, give you receipts with our autograph engraved, and in particular be able to exhibit a certificate of authority wholly in our handwriting, the signature of which shall be a *fac-simile* of the engraved one.

S. & H., OF GA., Writes us, that "About nine months ago we sent three dollars to Columbus, O., and only received two numbers. We wrote him afterward, but received no answer." This is a fair sample of numerous complaints received at this office. The public, in ignorance that the "Columbus sheet" has been defunct some months, continue to send money to the ex-publisher, get two or three *old and worthless* numbers, and when they write for an explanation, get no answer; *but will they ever get back their money?* This is the man who, in 1857, promised to meet "his friends on the level, and part with them on the square." Verily, consistency is a jewel.

I. M. C., OF VT.—We do not get up designs of the kind you send for; all matters of that description we furnish in connection with our painting department.

E. N. B., OF TENN.—The few copies of the *Carriage-builders' Art Journal* sent to this market were all sold before we could secure one for you. The price, including postage for each part, is 78 cents. Shall we return the money sent, or will you wait six weeks for a copy?

T. F., OF N. J.—You had better await the result of a judicial decision before paying any person for an infringement claimed. This subject of perch-couplings will be thoroughly sifted very soon, we trust.

J. S., OF MASS.—Yes, if you send your subscription soon.

A. C., OF PA.—We can still supply any number of the First Volume you may require for 25 cents.

S. E.—See our article, "Charts," in another column of this number.

### A TEN DAYS' VISIT ABROAD.

It has become proverbial, that editors scarcely, if ever, find time from their labors to go abroad. Such has been our situation heretofore; but laying aside all conventionalities, and deserting the chair editorial, we formed a determination to at least appropriate the few days at this season usually given to pleasure, in visiting our friends in the country. For this purpose we stepped on board of a Hudson River steamer bound up stream. A few hours' sail carried us amidst some of the finest scenery in the world, and past some of the most celebrated places in the history of the War of the Revolution. Passing successively Yonkers, Tarrytown—one of the most noted in the history of our country, as being the place where Major André was captured—Sing Sing with its State Prison; the far-famed Rockland Lake, remembered by all New Yorkers—especially in the dog-days—for its cooling ices in relieving their parched tongues; and other places of note; we found ourselves among the Highlands of the Hudson, that scenery, admitted by all who have seen it, to exceed in interest and beauty that of either the Rhine or Switzerland. Here at the entrance to the Highlands stands on an elevation a light-house where once stood a fort, the scene of a wonderful exploit—one of the most daring during our struggle for independence. On the evening of the 15th of July, 1779, Gen. Anthony Wayne, than whom a braver man never breathed the air of freedom, with three hundred men, at the point of the bayonet, successfully assaulted and took the British garrison fortified there under Col. Johnson. Our readers will find this gallant episode in our national history fully detailed and illustrated in the second volume of Lossing's Field-Book of the Revolution, to which, for want of space, they are referred.

A short distance above is Caldwells, with its short and stunted growth of trees, and where but a few years since the attention of credulous graspers after gain was concentrated, in the hope of seizing the treasure supposed to be ingulfed in the sunken craft of the renowned piratical Captain Kidd. By the way, we have known of more reputed places where "Kidd's chest" was hidden, than we could find room to chronicle in this article. There is scarcely a sand-bank or elevation along the shores of Long Island Sound, which has not, at some period, had its nocturnal searches after this same "chest." The "holes" still unfilled along the shores of Connecticut in particular, remain as monuments to this folly, in seeking for *supposed* "hid treasures."

But to our journey. Turning a point in our voyage, there is presented to the view of the tourist, one of the grandest views imaginable, and to one uninitiated, the way ahead appears completely land-locked, and he wonderingly begins to speculate in his mind as to how a steamer can possibly proceed; when suddenly her progress, as by magic, opens to his senses the pathway, and at the

same time overwhelms his mind with awe profound. Soon he is abreast of St. Anthony's Nose, through the end of which is tunneled an aperture, through which daily passes the vulgar cars of the Hudson River Railroad. A short distance, and another winding in the river brings us to West Point, and Cozzens' Hotel, a favorite summer resort for the dust-breathing "cits" of New York. The enchanting views, the ringing of the steamer's bell, added to its returned echoes from a rock-bound and confined landscape, lend an enchantment to the lover of nature, never to be forgotten. Who has not heard of West Point—its intelligent cadets, its gallant and useful commandants in our late war with Mexico? Another sudden turn in the river, and there is spread out before us a grand panoramic view of the public buildings, and other monuments of national grandeur, sufficient to awaken the most sleepy patriot to ask himself :

"Lives there a man, with soul so dead,  
Who never to himself hath said,  
This is my own, my native land?"

Higher up is the Crow's Nest, and Idlewold, the one the country-seat of Gen. G. P. Morris; the other of his partner in the *Home Journal*, N. P. Willis, Esq.

Very soon we find ourselves at Newburgh, some sixty miles north of New York, on the western bank of the river. Here we found our old friend, Mr. L. J. Bazzoni, as full of business as usual, among whose hands, in a very short time, we formed a club of thirteen subscribers. We presume that hard times has little or no effect on our friend's business, as we saw he had plenty of work. In this village is situated the house known as "Washington's Head Quarters," where the tourist will find collected together many of the relics of our Revolutionary times, and which cannot fail to well repay the curious antiquarian for an hour's investigation. Having laid the foundation of a club at the Messrs. Weygant & Sons, we proceeded to Poughkeepsie, and at the principal shops, the Messrs. Brooks & Mashall's, Fredrick & Co.'s, and Streit & Lockwood's, we found many of our old as well as many new friends. We are under many obligations to the craft for their uniform kindness to us in this place, which we had occasion to specially notice in this work a year ago. Here we had the pleasure of forming the acquaintance of one of the firm of Messrs. Hauna & Storm, whose establishment is known to the public as an extensive depot of carriage-makers' materials.

At Rondout, which seems to have claimed the especial notice of our associate last year, we arrived just in time to view the effects—rather to see the consternation—produced by an extensive land-slide, at an elevated point of land known as Ponkhookie. Here the Newark Cement Company have their works. They supply an article which has to be taken from beneath a bed of lime-stone, and other superincumbent materials, to obtain which, extensive operations are carried on in the bowels of the mountain. In the course of these la-

bors, a deep chasm, some twenty feet wide and fifty feet deep, was formed high up in the mountain. It is supposed that the rains and frosts of the past seasons had so far loosened the mass of rock, earth, &c., still higher up, and forming, in connection with a forest of trees, a back ground to the scene, that at half-past six, the evening of our arrival, this deep chasm was not only completely filled in, but, dreadful to think of, running over, precipitated earth, trees, and rock down the steep, to the danger of many human lives. Some of these rocks would exceed eighty tons! Providentially, although precipitated down the hill with a thundering noise and destructive force, among habitations and busy men, yet none were seriously hurt. We saw no less than three huge rocks between as many cottages, which had forced their way through fences and other obstructions, but fortunately between the buildings; otherwise these would have been destroyed. The most singular tale in this story is the fact, told us by the mother herself, that the child of Mrs. Doodney was amusing itself with a pet rabbit, in the yard, when a huge rock came impetuously down the hill, and grazing, scarified its face, while at the same time the disturbed air forced the child beyond the reach of further harm, the mother supposing at the time that it was certainly killed! This huge rock measured 6½ by 8 by 11 feet.

From Rondout a short drive takes us to Kingston, the place of considerable carriage making. This, in our Revolutionary history, is known as Esopus; a place where Britain immortalized herself by committing it to the flames. Here we found our friend Mr. Hermance, as usual, ready to extend to our enterprise a fraternal hand; may his success in life be equal to his kindness to us: also, we made the acquaintance of Mr. Merritt, who not only received us warmly, but did all in his power to further our object. These two principal shops in the place, gave us a handsome patronage.

From this place, by rail, we went direct to Albany, where an agent had preceded us; but notwithstanding, we obtained a club of ten in the shop of Messrs. Gardinier & Selkirk. In this factory there seemed to be the best of feeling between the employers and employed, which cannot but result in the happiest consequences to all parties. At the factory of Messrs. Kingsbury & Whitehead, we saw in progress of completion, the prettiest hearse we have seen yet; we are promised a drawing, which we hope to give in our October issue. The other shops having been previously visited, parting with our friend Winne, we hurried on to Schenectady, a place where carriage-makers seem destined to starve.

In the morning we journeyed along the valley of the Mohawk to Utica. This whole route presents one of the richest soils for the agriculturist, as mine host at Utica said, that "ever lay out-doors." The farmers are described as all rich and out of debt: an ideal state of superlative happiness. At Utica we formed the acquaintance of Mr.



Blackwell and Mr. Bates, to both of which gentlemen we are under lasting obligations for their kindness to a stranger. We had a fair opportunity of inspecting their productions, and honesty and candor compel us to acknowledge that they are an honor to the craft. Their modesty forbids our saying more; less, truth will not permit. We were much pleased with this beautiful city. Genessee street—its Fifth avenue—is apparently a paradise for residing in. The beautiful edifices and extensive grounds, tastefully crowded with shrubbery and flowers, breathed forth a balm pleasing to our lungs.

From Utica to Rome, and thence to Watertown, where we found a few of the craft. From an employee in the paint-shop of Messrs. Wilson & Co., we obtained some ornamental designs, with which we hope to be able to enrich our columns hereafter. Returning again to Rome, through some of the wildest country, having resisted the strongest invitation to a day's fishing at Cape Vincent on the shores of Lake Ontario, we left for Elmira, Owego, Binghamton, and home, over the Erie Railroad. At Owego, on the Susquehanna, just starting business in a new shop, we found Messrs. Moore & Ross, where we soon formed a club of patrons. These gentlemen warmly interested themselves in our favor. Their establishment here has thus far been favored with success, which they are well worthy of. At Binghamton, we called upon Messrs. Miller, French & Co., and had they been our brothers, instead of friends, they could not have greeted us more cordially. Their society and conversation cheered us nobly, and it gives us great pleasure to find that, although comparatively new beginners, their mechanical industry and ingenuity is promising of success.

Arrived at home, we found such a collection of letters from abroad, as required some time to answer, which explanation we hope will satisfy a portion of our friends, and let them into the secret of why they were seemingly neglected. We cannot close this article without returning our thanks generally, to the craft who so cordially and kindly welcomed us to their work-shops. We shall return to our editorial labors, cheered by their smiles, and with renewed incentives for "studying to please."

#### COMMERCIAL ASPECT OF CARRIAGE-MAKING.

HAVING recently visited many of the inland towns of this State, in person, and heard the reports of trade from the lips of our agents in other quarters, we think we are well qualified for saying something advisedly of the condition of carriage-making in the rural districts and elsewhere, at the present time.

The subject may be reviewed in the light of our recent revulsion. Years of prosperity having enlisted, not only the regularly educated craftsmen, but likewise a large swarm of others, such as carpenters, cabinet-makers, and even tailors and other parasites in the business, all of

whom, although warned by the aspects of the times, yet felt that they ought to still do something for their families' livelihood. This done in the hope that the times would soon mend—vain hope—soon produced in every place, more carriages than the moderate demands of the public required, for consumption. The result is, there are now made and on hand carriages enough to supply the country for at least two years.

Soon after the "crisis," such few as still had the means left, still purchased, but only when this could be done cheap—say at original costs to the manufacturer—and which offers to some panic-stricken manufacturers in great want of money, were but too eagerly accepted. But times still getting worse and worse, even this class of patrons soon vanished. Manufacturers still hoping for better times, kept on their accustomed number of hands, at former prices; the result is, that now the warerooms in every little town are full, with none to purchase. Latterly many journeymen have been thrown out of employment, and consequently there are many with the prospect of a hard winter before them, unprepared to meet its rigors.

Let us see how this mode of doing business has operated where there are two or more shops in a place. A firm trying to keep up appearances, continues to keep on his hands as in good times, until his pecuniary wants compel him to sell at costs. So he offers his productions at reduced rates, thinking thereby to bring all the grists to his mill. To prevent this, B puts his work *below costs*, and this mode of doing business having been practised upon for two years, both *now* find themselves "in a bad box," for having *lowered* the price once, it will require some years of good times to get it up again. The natural consequences of all this are, that the journeymen are either *cut down* in prices or put on "half-time;" the bosses find fault each of his neighbor for having brought the prices down—both having had an equal hand in this business; we gather this from their own tales—until one of them desires to go to some other place and *start anew* a business he has so much himself done to ruin at home, and to enact, should he live to carry on the business another fourteen years, the same scheme and the like result there. These are the deplorable facts, but as human nature is the same everywhere, perhaps it will never be otherwise. When business is good there is very little danger of such results, it is only in dull times, and when prices are falling that carriage-makers find the greatest need of being on friendly terms with each other, and of exercising prudence in fixing their prices. To all, however, a little gratuitous advice may be acceptable.

In any case where you find a neighbor "selling at a sacrifice," send him all the customers you can, and *kill him with kindness* as speedily as possible; bear patiently your lot with as little expense as possible, until "good times"—as they most assuredly must—roll round again, and you will find all *come out right*.

### A WHISPER IN THE EARS OF THOSE CONCERNED.

WE can still supply the public with any back numbers of either the first or current volumes of this work, at 25 cents per number. The present is a good opportunity for our friends to complete their first volumes with the missing numbers, preparatory to having them bound. Our uniform covers will be furnished for forty-four cents, by calling at the office—not containing any printed matter, covers cannot be sent by mail, except at letter rates, which costs too much. Where a number are to be bound, however, this could be done by express at low rates to each.

The first volume, bound, can still be had for \$3.50; or in numbers, for \$3. Where the first volume is purchased in numbers, and the second one subscribed for, \$5 will pay for the two.

Those who have not seen the first volume, are informed that it contains the square rule—generally known (although incorrectly) as the French—for making different kinds of bodies, complete; in fact, it never has been so perfectly given in any other publication. Besides this, a series of lessons, as applicable to drafting carriages by scale, and other matters of the deepest interest to carriage-makers, will be found therein. Not the least of these are our history of carriage-making from the earliest times, and other mechanical and literary matter of a character well calculated to give the volume a living interest and command for it a place in the library. The illustrations, numbering one hundred and ninety-five, have been most of them drawn and engraved expressly for this Magazine, and with a degree of fineness never before attempted in a purely mechanical work. An early order is invited from those who would not fail of securing it.

### ANNOUNCEMENTS FOR OCTOBER.

WE shall continue in our next number the Auto-biography of Caleb Snug, unavoidably crowded out of this.

We shall also commence the publication of an interesting article written for us, entitled "The Outlaw's Bride," which, although given in a novel style, is of an interest only belonging to a truthful tale.

An article on "Solitude," from the pen of our attentive correspondent, S. E. Todd, Esq., will also be given, the tenor of which is well calculated to make the reader a better man. The mechanical and other matter connected with that number, we think, will bring it fully up to the standard of merit accorded to any one we have yet published.

### A BUGGY BOAT.

ANOTHER of those singular contrivances one occasionally hears of, but seldom sees, has been patented by a gentleman of Providence, R. I., who, we think, will find the sale of his buggy less profitable, but fully as useful as his "Pain Killer." As its name indicates, to facilitate travel, and to enable a person to perform a journey in a direct

line through lakes and across rivers, a carriage of this kind *might* be useful were it required. This amphibious vehicle is formed of a common row-boat mounted on three wheels (we presume an improvement upon *that* "Equirotal"), the spokes of the two hind wheels being so shaped that they become paddles, when operated upon, as they are, by cranks and belts fixed in the inside of the boat, to propel the vehicle through the water, so that they serve as paddle and ordinary carriage-wheels, a capital idea for transformation to rail-cars in these times of rotten bridges and rail-carriage immersions. Before purchasing, however, our friends had better be sure, and see if some *ambitious speculator* does not stand ready to drop down upon them for damages, *since every popular invention* adopted nowadays has some previous claimant who stands ready to blackmail the craft.

### CHARTS.

FIFTEEN cents in postage-stamps will secure a single chart for your office, with twenty-four cuts—mostly light carriages—10½ by 13 inches, with a space in the centre to place your business card. The above price includes the postages.

Should you want 100 copies, with your card printed in the centre, the price will be \$12; for 200, \$22; for 500, \$50. These last sent by express at the expense of those who order.

### LITERARY.

THE ATLANTIC MONTHLY for August is on our table, beautifully printed on beautiful paper, which is more than can be said of some other magazines equally pretentious. The matter and general getting up of this work is creditable to our American periodical literature, and, until its advent, had long been needed. We think the literary contents far more interesting than the generality of European magazines, and are happy to find that it is receiving that patronage from our countrymen it so richly deserves. "The dramatic element in the Bible;" "The Ring Fetter;" "Night Birds;" "A Trip to Cuba;" "The Minister's Wooing, &c.;" together with that never-tiring genius, "The Professor at the Breakfast-table;" "The Italian War, and "Literary notices" constitute the titles of the principal articles in this number.

Published, at \$3 a year, by PHILLIPS, SAMPSON & Co. Boston, Mass.

THE CARRIAGE-BUILDERS' AND HARNESS-MAKERS' ART JOURNAL, Part II., being for July, has also come to hand. The interest presented in the first number seems to be well maintained in this second part. Its articles are, briefly, an article "On the disadvantages arising from the use of conical or beveled wheels as compared with the cylindrical;" "Application of machinery to carriage-building;" "Carriage ruts in country districts;" "History of Carriage-building;"

"Color, its application, &c.," with four plates of working drawings and colored illustrations of interest to the craft.

Price 75 cents per part, or \$9 a year (postage 3 cents additional when sent by mail). London, TALLIS & Co.; New York, D. APPLETON & Co. Can also be had of the Publisher of this Magazine.

THE SHIFTING-RAIL EXCITEMENT—GREAT MEETING OF THE NEW HAVEN COACH-MAKERS.

IN accordance with the invitation extended to us through the kindness of Homer H. Dikeman, Esq., their intelligent Secretary, after a three hours' ride by rail, the evening of the 17th of August, found us in the beautiful city of New Haven, where, in Brewster Hall, we saw assembled as respectable and as intelligent a looking body of coach-makers as this or any other country can produce. Three hundred or more of the manufacturers in New Haven, and the surrounding villages, had come together to vindicate their rights against what they allege to be a base attempt to follow the measures undertaken by a former "confidence man" in bleeding our noble craft for the special benefit of *pretended* patentees. From the spirit manifested on this occasion, we predict that it will be "a spell if no more" before the speculations in this instance will realize any thing out of *their* shifting top-rail speculations from our New Haven friends. The present prospect is that they will have "a good time" in "lawing it" before a fortune is realized.

In our October issue, we design to give our readers the correspondence in the Secretary's hands, certified copies from the Patent Office of the patentee's claim, and other interesting documents, with illustrations kindly furnished us by the committee, as shall give our friends a clear understanding of the subject. Meanwhile, we hope our country friends will not be frightened, and foolishly throw away their hard earnings in settling with any "visitor" that may make a special demand upon them, until they "see the end" of the legal proceedings taken by the New Haven carriage-makers to test the matter, and which we have, after investigation, every reason to believe, if prosecuted by the other side (?), will terminate in their favor. The late day in the month, when this meeting was held, prevents our giving more than the speeches and other proceedings at this time. These we have specially reported for this magazine.

Our readers will understand that some weeks previously, our New Haven friends had met, and taken the preliminary measures to protect themselves against the demands for remuneration for the infringement of a patent issued to one Harmon Hibbard, July 15, 1851, for shifting, or movable carriage-tops. That meeting had appointed Messrs. D. A. Benjamin, Henry Hale, Freeman B. Plumb, Wm. A. Doolittle, and H. H. Dikeman, a Committee to investigate the validity of the patent, and for this purpose to collect

such evidence as they could find, and to report at a subsequent meeting. As the carriage-making interest of New Haven is represented by fifty-two factories, a very large amount of capital and many hundred men, the validity of the patent is of much importance, and the investigations are of great practical value. The Committee on Investigation, by order of those who appointed them, called a meeting at Brewster's Hall, on that evening, to hear their report, and take such action to protect the rights of the carriage-makers as might be thought proper.

This second meeting was called to order by Mr. J. P. Bunce, the Chairman, and the Committee appointed to investigate the validity of the patent claimed to have been infringed, reported as follows :

The undersigned Committee, appointed by a meeting of carriage-makers to procure copies of specifications, and models of Hibbard's adjustable carriage-top, beg leave to report :

That they have attended to the same, and procured from Washington certified copies of all assignments that have been made of the patent, as they appear on the records in the Patent office, as well as a certified copy of the model, all of which we now present.

And as your Committee have been unable to find the owners of the patent, all persons with whom they have consulted, denying all ownership of the same, we therefore recommend that a reward be offered for the present owners of Hibbard's patent.

All of which is respectfully submitted.

D. A. BENJAMIN,	} Committee.
HENRY HALE,	
F. B. PLUMB,	
WM. A. DOOLITTLE.	
HARMON H. DIKEMAN,	

The Secretary, Mr. H. H. Dikeman, then read the copies of the application and specifications of Hibbard's Patent, and explaining the peculiarities of the same by a model, and by a carriage seat, with the patent adjustments added thereto, and showed what was claimed by it, and how far it interfered with or amended the style of carriage-top manufacture, as carried on by the makers of that city. He said that it was true that Mr. Hibbard's patent top could be adjusted to any seat wider than the one for which it was originally intended, but not to any narrower seat. He stated also that the patent had been assigned twice; once by Harmon Hibbard, to Jared A. Hibbard, and by him to Hanes & Handy, in 1855. He added that no owner could be found for the Hibbard patent, and he did not think any could be found, for the thing was not worth owning.

The report of the Committee was accepted, and the committee discharged with the thanks of the meeting.

The Chairman then requested any gentlemen present who might have any thing to say on the subject to free

their minds, when Mr. F. B. Plumb inquired who it was that employed those men to go on and sue carriage-makers for infringing on Hibbard's Patent. Here men were claiming damages for the manufacture of carriage-tops that had been in use for thirty or forty years. He would like to know something about it.

The Chairman couldn't tell him any thing further than what he had said. The patent here shown had two ends, and, for the life of him, he couldn't tell on which end the parties were suing.

Mr. Plumb said that they pretended to have a model to cover every thing, but he, for one, didn't believe the yarn.

Mr. George Cook rose and said, that he could explain all about the two ends, in reference to which there was so much idle talk. The model made at our shop, of which the seat shown on the platform is a copy, was made with two ends, one end showing Hibbard's patent, the other representing the rail as made by ourselves and others, for the purpose of showing the wide difference between the patent and the thing claimed to be an infringement. With this model we could show and explain, and did show and explain, that difference to some of the best patent lawyers in the country; but, notwithstanding, it was their opinion that Hibbard could sustain an infringement. As I have said, the model was made at our factory, and the design of it is ours, to show, as I said before, the difference between the patent top, and the top generally manufactured hereabouts, *and for no other purpose.* I would say that the parties talked of suing our firm on both ends. The first we ever heard of this patent, of which we have made about two thousand, was on the receipt of a circular from York State, informing us that we had been infringing on Hibbard's patent, and that we would be held responsible for so doing. We at first would not settle, but afterwards, on examining into the matter, we came to the conclusion that we had better settle to avoid a greater expense. We would not have the large and respectable body of carriage-makers in New Haven, think that we acted injudiciously or like fools, without searching into this matter, although we do not profess to know any too much. For this reason the carriage-makers ought to show some pity towards us.

Lest there might be some in this room who do not know me, I will state that my name is Cook. I had a note from the Secretary, inviting me here to speak. If there is any gentleman here present who has any questions to ask, I hope he will do so, and I will answer him, as far as my information extends, for their benefit. Some have said that we own the patent. If we could own a patent as good, we would like to do it. We *did* work as hard as we could to own it, and did what we could to get it, and made up our mind to pay a thousand dollars, and more to get it, if necessary, and sent a man to purchase it, so as to own it. I

don't see why we should be persecuted for it; but we don't own this patent to the extent of one farthing.\*

Mr. F. B. Plumb arose and said: Perhaps Mr. Cook can give us some information as to the ownerships and claims of the Hibbard's patent, and I hope he will do it.

Mr. Cook replied, that as Mr. Plumb had honestly asked for information, he would give it. The man that we traded with is a Mr. Seymour, of New York State, who claims "power over the whole thing." We found on examination that we were in for a law-suit, or else that we must settle for the infringement. We made up our minds to do so. A man, not a carriage-maker, advised us to that course. I supposed that carriage-makers were friendly to a man when he attended to his own business, but I find there is an impression that the Cooks ought to be annihilated. The Cooks wish to be in friendship with their fellow-craftsmen and will try and behave themselves, and act like honest fellows, if they will let them.

Mr. Plumb said, some had tried to buy this patent and could not. He wanted to know if Mr. Seymour acknowledged that shifting rails were in use before Hibbard's patent. This is altogether different from that of Hibbard's patent. If a man gets up a patent, he ought to have the use of it; but when a man undertakes to get rich out of a thing which has been in use fifty years, I am opposed to it. I hear that carriage-makers are like to be sued for using a sliding seat. By and by they will be called upon to settle for using a wheel to a carriage. If I go into business and fail, I'll fail; but when a man undertakes to rob me, I'll fight him like a tiger. (Applause.)

Mr. Cook: All Mr. Plumb says is right. I feel just as he does, but I don't believe in biting one's nose off, to spite his face. This matter may be hard, but it is nevertheless just. I had received a letter from the Commissioner of Patents, stating that a claim for a patent, on the very same top which we have been making, had been offered at the Patent Office and refused, on the ground that it infringed on Hibbard's patent. If it is hard, carriage-makers had better try and make it soft.

Mr. Dikeman said he would give any man his buggy to tell the difference between the patent top and the one carriage-makers had been using. It was one and the same thing, and exactly like the top made years ago.

Mr. Ralph Smith asked Mr. Cook to read the letter.

Mr. Cook handed the letter to the Secretary, who read

\*At the close of the meeting Ira Dikeman, Esq., asked Mr. Cook if he had ever seen the model of Hibbard's patent before that evening. He said he had not. Mr. D.: I would like to ask Mr. Hayes, the man who spoke last, if he knew where the bogus model was got up, that we were called upon to settle by. Mr. C.: If the question had been put to me, I should have said it was got up in our shop. Mr. D.: Can you tell me who put that label upon it—HIBBARD'S PATENT? Mr. D.: I cannot. Mr. D.: Have you any idea that any one would have settled, had a genuine model been shown them? Mr. C.: I always said a man was a fool for settling for a thing, before he knew what he was settling for. Mr. D.: And yet you say to-night, that you have settled without seeing it!

it. It stated substantially just what Mr. Cook had previously told the meeting, that a patent had been denied to a claim made by parties making a top similar to the one now in use in this city.

Mr. L. G. Peek, not exactly a carriage-maker, but a legal friend of many of them, rose and said that the facts seemed to be that in 1851, Harmon Hibbard got a patent on a shifting buggy top, and that in 1854 somebody else had tried to get a patent on some fancied improvement, and had been denied.

Mr. Cook said just so, and showed drawings of the top which they use, and which is claimed to be an infringement.

Mr. A. P. Munson asked how gentlemen knew that the model here on exhibition was a true model of the patent itself. He said that he did not know of anybody that claimed it was an infringement. How do people know anything about the patent? If they want to sue, why don't they do it on the patent itself? This suing for an infringement don't seem to be the thing. There is no carriage-maker but has made one or more of these tops.

Mr. Samuel M. Wier said that they needed no further information. The Committee had done their duty well and promptly, and they deserved hearty thanks and remuneration. Carriage-makers should act like men—should band together and contest the matter, and give this man a chance to show good grounds for its ownership. The Cooks have settled; we are now called upon to settle. Let us do nothing but what is right, and submit to nothing wrong. We should band together and determine to carry on a lawful business, and if any man attempts to bleed us on false patents, fight the thing through. The carriage-makers should sustain themselves. I feel a personal interest in the matter. I received a notice from Sheldon & Munson to call at their office on important business. On calling, was informed that I had infringed on somebody's patent in making shifting tops. I denied it, as I did not believe it true. Messrs. S. & M. had said that a marshal would be sent down the next day to close us up, but he has not been there yet, although I am anxiously waiting to see his face. I have been in business for thirty years, and feel confident I am right now. Told Sheldon & Munson to go ahead and sue. I am in the puddle with the rest, and want to get out when others do, and no sooner. There are laws to govern patents, and any ignoramus ought to know that using an article which had been in vogue for thirty years is not and can not be an infringement of a patent. To have a man come up now, and try to drive us out of the business, is perfect nonsense. Should any one apply for a patent for *turning* a wheel round, he could get it. I am indignant, and would pay thousands to contest the thing, but not the first farthing as tribute-money. The carriage-makers have been grossly insulted and outraged. The patent humbugs are all a

set of swindlers, but if men would only stand shoulder to shoulder, all would come right end up. I move that a committee be appointed to draw a contract for carriage-makers to sign, banding themselves together to stand by and carry the thing through.

Mr. Peck desired to amend by moving that the committee do what in their judgment seemed right and proper.

Mr. Wier desired to know the feelings of this meeting. He for one was willing to sign a contract, and pay his share of the expense. He moved that a committee be appointed to arrange for a union of carriage-makers, to resist unjust claims upon them, and to prepare a contract to be signed by all of them, agreeing to prosecute the investigation of Hibbard's patent.

The motion was adopted, and on motion of Mr. Hale, a committee was appointed by the chair to nominate the committee to be raised.

The chair appointed Messrs. H. Hale, S. M. Wier, L. F. Comstock, F. B. Plumb, and A. P. Munson, Nominating Committee. These having retired,

Mr. Ralph Smith inquired about the practice of rejecting patents—whether, because an application was rejected because it was an infringement of Hibbard's, it proved that Hibbard's was good?

Mr. Cook said he offered the rejection of Hanes & Handy's patent, as information obtained for his own use, and he did not believe that the present owners of Hibbard's patent knew he had it.

Mr. Plum asked, have we any assurance that this patent applied for by Hanes & Handy is the one which was rejected? We see the man got no patent. Is there any evidence to show that H. & H. ever applied for the shifting rail now in use?

Mr. Cook here made some remarks which we failed to hear, except that the evidence he presented was his own, not that of the patentee.

Mr. Plum: It is not the patent they are suing us on; it is the infringement.

Mr. John R. Lawrence, of New York, being called upon, said he knew nothing particularly on the subject. He knew shifting tops had been made for many years, but he did not know now whether they were the kind patented by Hibbard. He did not understand that the coach-makers were here to break the patent, but to defend themselves.

Mr. Cook had also made shifting tops twenty-seven years ago, when an apprentice, and got kicked for not making them good.

The Committee having returned, submitted the following resolutions, which were read by the Secretary:

*Whereas*, Certain parties have claimed, and do now claim, a patent on the shifting rail for buggies, now used by carriage-makers, and also claim the exclusive right of making and vending the same; and *whereas*, the rail we

now use, we have been using for twenty-five years; therefore,

*Resolved*, That the claim for an infringement on Hibbard's patent is a fraud, and that the model exhibited by Messrs. Munson & Sheldon, Attorneys, is fraudulent, and can be proved by a model and specifications, bearing the Patent Office seal.

*Resolved*, That the attempt to obtain money by exhibiting said model, made in this city, is a fraudulent transaction, and we recommend those who have paid money to settle on an alleged infringement, to commence a suit for the recovery of the same.

*Resolved*, That we will not give one penny to settle said alleged infringement, but will give liberally to defend our rights.

*Resolved*, That we consider the claim for a patent shifting rail, an attempt to monopolize and control the whole business, and we believe that the statement that "two or three large shops ought to do the whole carriage business of New Haven," and the claim for a patent shifting rail, have one and the same view.

*Whereas*, it is the opinion of many carriage manufacturers of this city, that collections for infringements of patents relating to the several parts of carriages, have become a prevailing nuisance, irresponsible and dishonest persons finding that by threats of commencing suits, parties so threatened, will pay small sums to settle such claim rather than be compelled to defend vexatious suits and be forced into expensive litigation; and that more money can be realized out of such collections for infringements, than by letting rights for a fair price to use such inventions; therefore,

*Resolved*, That in the opinion of this meeting, it is necessary for the carriage-makers, without delay, to adopt such measures to defend their mutual interests as may be most expedient.

*Resolved*, That a committee of ten be appointed by this meeting, with power to add to their number, whose duty shall be to collect subscriptions from the several carriage-makers, thereby creating a fund with which to defray the expenses of investigating and testing all claims for infringements upon real or doubtful patents, upon application from any carriage-maker who may subscribe on the books of this committee.

Mr. Charles E. Hayes moved that the resolutions be laid on the table. Thought precipitous action injudicious. The only response to which was a storm of hisses.

Before passing these resolutions, Mr. L. T. Comstock, of Plymouth, edified the audience with a tale of one "Horse-heads" having called upon him for infringing upon a patent coupling, and that rather than have a law-suit, he had settled. He had found that his New Haven friends had done so, and they in the country being a little *green*, generally did as they do.

On motion, the resolutions of the Committee were adopted.

A motion was here made and carried, that the above resolutions be printed and distributed in pamphlet form, and scattered all over the country—one voice only dissentient.

Mr. Plumb thought that "we ought to assist those who

had already been sued," but his proposition was not acted upon.

A motion was here made and carried, "that we adjourn until called upon by the Committee, to meet here again." Carried.

The Committee, having provided models—one from the Patent Office, of Hibbard's patent, and a seat ironed something after it, and another showing the old, and another, likewise, the more modern way of applying a shifting-rail to a seat, the audience entered upon an examination of their relative merits with much interest; after which they dispersed to their homes, apparently fully determined "to see this matter out;" which we entertain no doubt of, they will.

OUR first and second forms having gone to press, we have been obliged to give up nearly the whole of our third to the proceedings of the New Haven Coach-Makers, in relation to the alleged infringement of the Hibbard Patent Shifting-Rail. This obliges us to lay over a variety of miscellaneous matter, our usual Patent Office Report, and our illustrated humorous department. The unusual interest manifested by our correspondents all over the country, leads us to believe that by so doing we are but studying the interests of the coach-making public, for there is scarcely a shop in the land where these rails have not been made.

#### FASHIONS IN CARRIAGES.

THE Elcho Sociable Landau is likely to become a general favorite.

Wagonettes, Landaus, Sociables, and all open carriages, are more in demand, and have met with a greater sale this year than for a considerable time past; and, in consequence, the sale of Broughams has suffered to a considerable extent.

The taste is for plain, neat, and good painting and lining.

Laces, silks, and trimmings are exceedingly plain, and in keeping.

The plain handle, in brass, is the style most prevalent in the best establishments.

There is a great variety of shape in "SOCIABLES," many being built the same sweep, back and front (kept faint), and open under the seats; the body wide, and roomy across the top; the "turn-under" varies much, with faint standing pillars. The imitation cane-work and carved osier-work panels are not quite so much in use with the best houses, where plain panels and a quiet style of painting are again prevalent. "Head wings" and straight "pump handles" are quite in favor.

"OMNIBUSSES," for private use, with movable heads, and back-rests *in lieu*, are very general throughout the country; small "MAIL PHÆTONS" and "STANHOPE PHÆTONS" in town. A new style of cart, hung low, called the "NORWAY CART," has been lately introduced, with great success. The superior kind of "BASKET PHÆTONS" still have a great run in country districts, superseding the low-priced basket "four-wheels," which have universally proved as unsatisfactory to the purchaser as to the producer.—*London Carriage-Builder's Art Journal*.



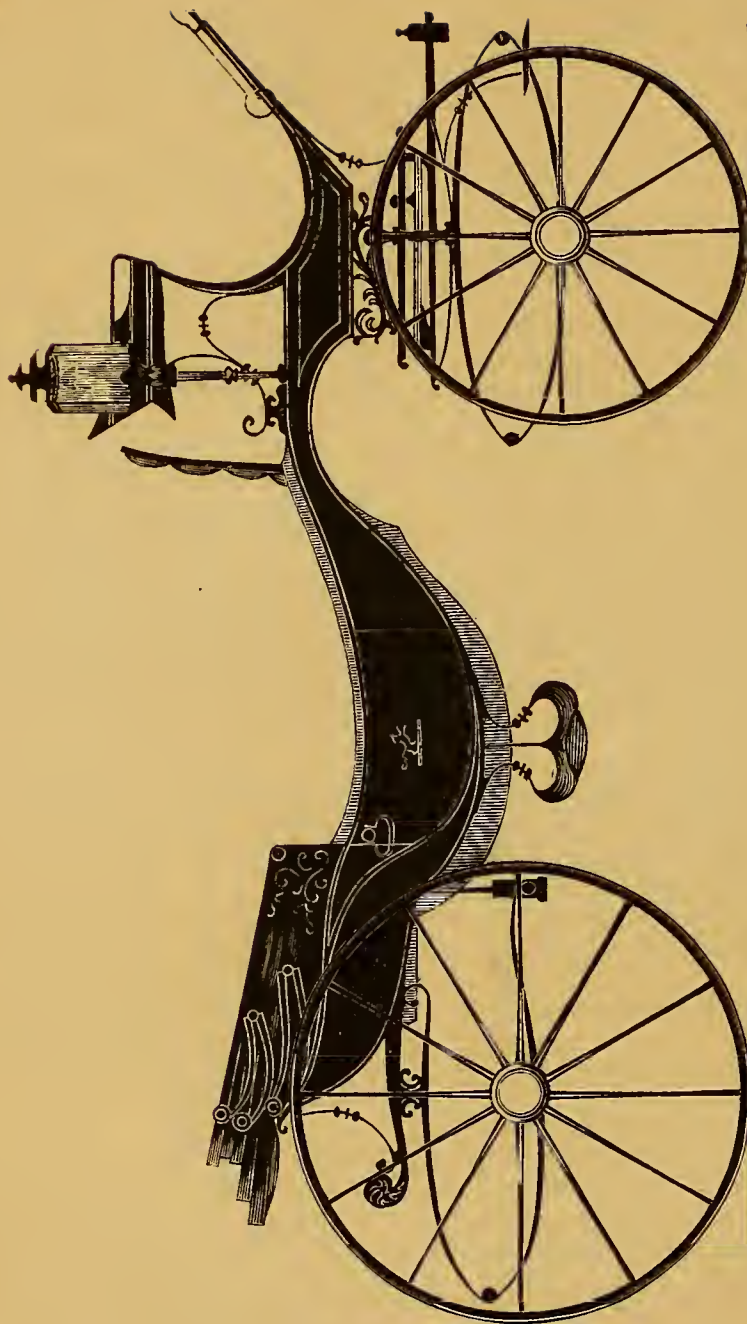

NAPOLEON BRETT.— $\frac{1}{2}$  IN. SCALE.  
*Engraved expressly for the New York Coach-Maker's Magazine.—Explained on page 87.*



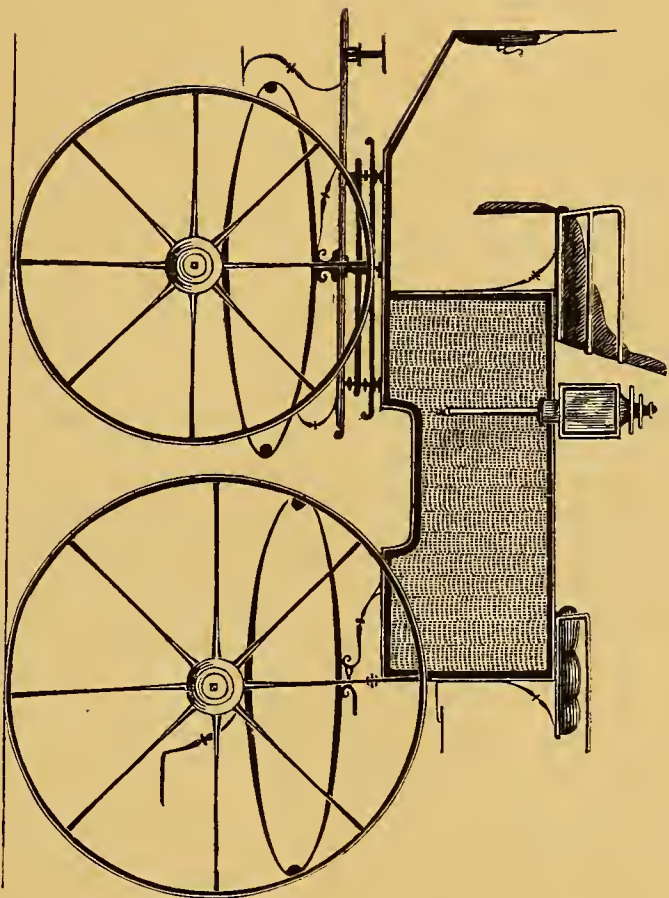

DOG CART.— $\frac{1}{2}$  IN. SCALE.

*Engraved expressly for the New York Coach-Maker's Magazine.—Explained on page 51.*





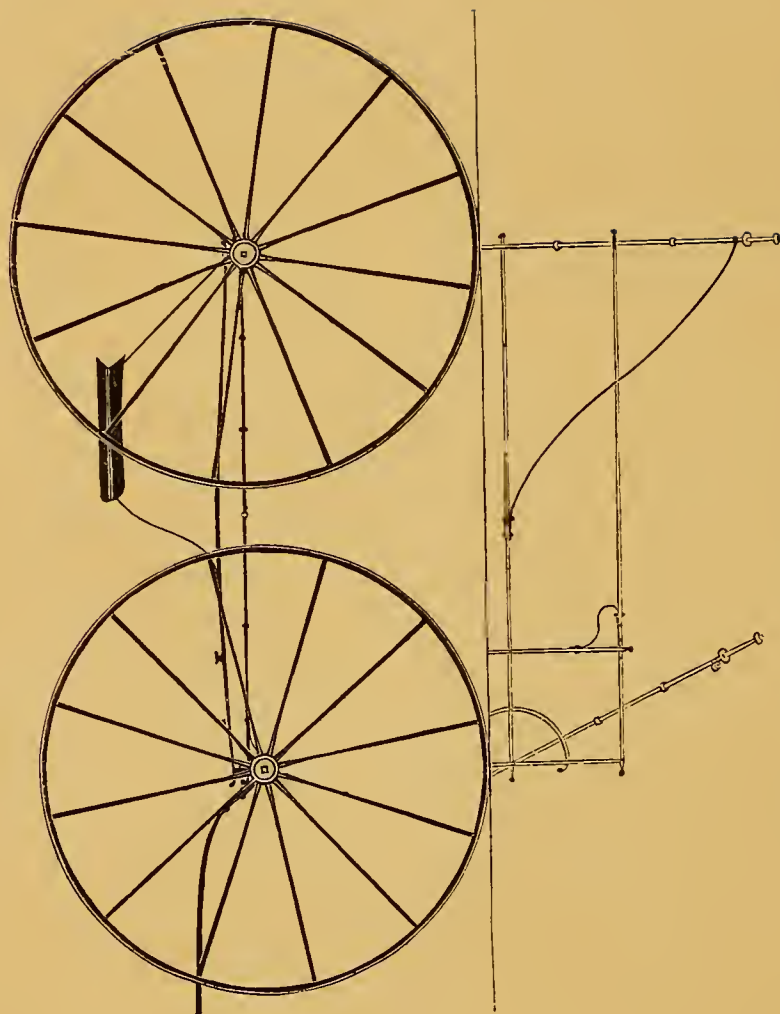

SKELETON WAGON.— $\frac{1}{2}$  IN. SCALE.  
*Engraved expressly for the New York Coach-Maker's Magazine.—Explained on page 57.*







DEVOTED TO THE LITERARY, SOCIAL, AND MECHANICAL INTERESTS OF THE CRAFT.

Vol. II.

NEW YORK, OCTOBER, 1859.

No. 5

### Miscellaneous Literature.

For the New York Coach-Maker's Magazine.

#### THE AUTOBIOGRAPHY OF CALEB SNUG, OF SNUGTOWN, CARRIAGE-MAKER.

##### CHAPTER XVI.

Caleb called out of bed at daylight to "do up" the chores—A Cyclopiian exercise in "blowing and striking"—The musical blacksmith—Caleb gives a practical lesson in gymnastics to an opponent—Cock-crowing at Flatt's Hall, practically repudiated—The "hard fare" realized—"Orange county" rather scarce—Mrs. Flatt finds a customer for her butter

THE following morning Mr. Flatt anticipated the sun by early rising—in fact, old Sol never could get up as soon as he did—and called "Caleb" out of bed at daylight to look after the "chores," a task little less than the one assigned to Hereules, by his enemy Eurystheus. By the time the morning portion of this duty (?) was through with, the rosy god of morn had fairly shown his face above the eastern horizon; but, by his blushes, he *seemed* to evince his sense of sympathy for the new apprentice, at Boss Flatt's unreasonable treatment so early. The time for commencing the regular day's labor had already taken the men and boys to their several departments in the different branches of the trade. Very unfortunately for me, however, on the previous Saturday night, the "helper" in the smith-shop had left; and to supply his place, as the boss said, temporarily, Caleb—he being the "youngest apprentice"—was told to take his place for a few days, but which I afterwards found prolonged to three weeks. To this, as I intended to learn the "wood-work," I gently demurred, but was met with the cool reply from Mr. Flatt, that he had no intention of keeping me at this kind of labor long enough to injure my health; nor did he *intend* that I should learn enough there, to do me any harm. I, from this circumstance, began to think that instead of joking, he probably was in earnest, when he said that he would give me "a plenty of hard work and *hard* fare."

This sledge-hammer practice soon operated upon my limbs in such a manner, that it very soon imparted a severe pain to my shoulders, rendering the first day's labor very *hard*, indeed. The "fireman" to whom I was assigned,

although a smart fellow and an ingenious mechanic appeared to take special pleasure, while his iron was heating, in standing in the doorway of the smithery, and singing at the height of his voice (not a weak one either), "O Betty

Arden, she is my darling," &c. This shop being located on the western bank of the Sawgetup river, which flowed through the village, the rude music was echoed across the water to the opposite shore, in so loud a strain as to attract the attention of the inhabitants, and pro-

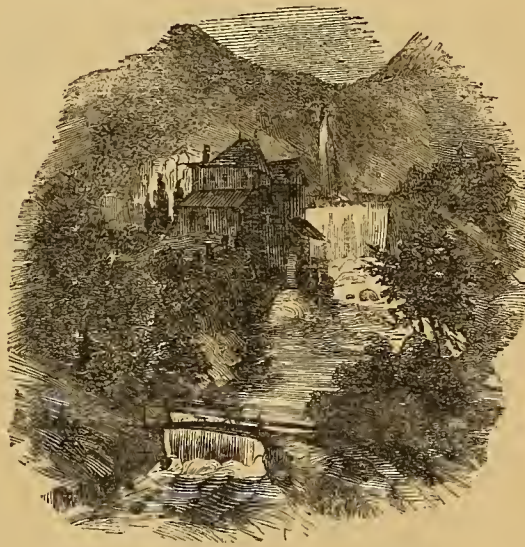

THE SOURCES OF THE SAWGETUP.

voke a laugh from his shop-mates, and to the evident amusement of the whole neighborhood. This peculiar habit constituted him a "marked character," and a great favorite with those fond of excitement, although his education was of the rudest kind. This man bore in full the name of a celebrated English lexicographer, but still he was as ignorant of letters as any native of central Africa may be supposed to be. Notwithstanding this fact, he possessed with an uncultivated mind a large share of sound judgment. He was beside a deeply sympathizing and much interested advocate for human rights, as pertaining to the interests of apprentice boys, as will be shown in a subsequent part of this history.

From the blacksmith's shop, having passed three weeks in "helping," I was transferred to the wood-shop, situated some thirty rods distant, and again put at the bench, in the old lesson of making wedges, of which I made in the first day about half a bushel. The quantity produced, attracted the attention of Mr. Towner, the junior partner, who was "graciously pleased" to commend my industry

in the hearing of my new associates. This was indeed very flattering to my vanity, and led me to think that my dear mother's predictions might at some future day be realized, that "Caleb *would* some day be a carriage-maker." My new position had brought on a home-sickness, during the first few days, which with one exception, had enlisted for me the sympathy of every shop-mate. That one wanting in the qualifications constituting good manners and perhaps as much in mischief as for any thing else, commenced annoying me in different ways. Being very tall and slender in figure, and for a boy of only sixteen summers, and somewhat *verdant* withal, he thought that *I might* submit to having my legs "chalked and sawed off" without much resistance. Soon, however, he found this a more serious business than he had anticipated. An overgrown and *coarse* animal himself, and somewhat my senior, yet he very soon found that the *sap* in my limbs possessed more virtue than his superficial observations had led him to expect. The first, the second trial was made; we clinched, and sooner than it has taken me to tell the story, I had my antagonist under my feet, amid a general burst of laughter from the whole shop. This victory settled the business forever; I was found *too tall* for him. He thought afterwards, probably, that prudence was preferable to precipitation, for he was content to let me alone.

The first summer, and also the autumn, passed away without any special occurrence worthy of record. During the winter, the old boss was accustomed to call me out of bed at three o'clock every morning through the week, to make the fires and have the shops well warmed, as he judged that both men and boys would do more work under such circumstances, than in a cold shop. In this opinion he was undoubtedly correct, but then *I* considered that such an obligation was rather a hard one. To be compelled to give at least three hours' time each morning to labor in the shop, when that time was required by a law of nature, for sleep, naturally inclined me to be a little rebellious; but what could I expect—had I not been promised by Mr. Flatt, "a plenty of *hard* work, and *HARD* fare"?

The time passed away heavily in making wedges, dowels, dressing the three sides of spokes and other parts of carriage stuff, varied by turning the grindstone, &c., during the first year of my apprenticeship. As every carriage-maker knows who was an apprentice thirty-five years ago, these constituted the first lessons of his initiation. The hard labor imposed by getting every thing "out of the rough" at that period can scarcely be realized in these days of saw-mills and steam-power, from which nearly every thing comes to our hand ready dressed.

The hardships of this period were greatly increased by the coarse and scanty supply of food supplied to our table. It would have starved an Israelite in a few days, unless hunger compelled him to break his vows. Pork and potatoes to-day, and potatoes and pork to-morrow, constituted our changes of diet. I, however, had an advantage over my shop-mates. I could at least once in the week visit Snugtown, and recruit my larder. My considerate mother used on these occasions to furnish me with a large cake, which being hid away in my chest, was resorted to daily through the week, for the purpose of satisfying my craving appetite for some little change in dictics. This, with the consoling remark from Mrs. Sung, that "my time would soon be out, when I would be my own man," nerved me with encourage-

ment and strength sufficient to endure the hardship of the week.

Once or twice in a week, was about as often as Mrs. Flatt could afford to give "the boys" butter for their bread. This seldom made its appearance until we were about to leave the table, *as our hostess was, unfortunately for us, troubled with a bad memory.* "Oh! I forgot the butter!" still rings in my ears. But her memory ought to have been "sharpened," for on one particular occasion, a fellow-apprentice had the boldness to return and finish his dinner with the "Orange county." This same person was the hero of another exploit, which gave our hostess some uneasiness, the relation of which we must postpone until our next chapter.



For the New York Coach-maker's Magazine.

### SOLITUDE.

"O SACRED Solitude! divine retreat!  
Choice of the prudent! envy of the great!  
By thy pure stream, or in thy waving shade,  
We court fair Wisdom, that celestial maid!  
There, from the ways of men laid safe ashore,  
We smile to hear the distant tempest roar;  
There, blessed with health, with business unperplexed,  
This life we relish, and insure the next."

How sweet and refreshing is solitude! What a rich retreat—after having been perplexed and harassed all the day with toilsome cares, and the petty ills which one must meet with in mingling with the world—to retire to his quiet and silent chamber, shut out all care, throw trouble aside, and feel that we are alone—secluded from the gaze of an unfriendly and deceitful world; and that no eye beholds us, save that which "seeth in secret." Here the burdened heart finds a never-failing cure for its little ills. Here bright hope beams in upon the darkness of the soul, with cheering effulgence; and in hours of deep despondency and irrepressible grief, irradiates it with joy and gladness. We love the pleasures of social intercourse, and the buoyancy and vivacity which meet us in the circles of the young; but how richly we enjoy the hour which invites to meditation in silence! How good it seems to get alone, by ourselves, and rest our weary head upon our hand, and *think*—to turn our thoughts within, and examine closely what is revolving in the bosom!



To many people, and sometimes those professing to be very good, solitude and retirement bring no charms, nor enduring enjoyment; but, on the contrary, discontentment, unhappiness, and misery. To them there is something awfully repugnant, in sitting down deliberately, alone, and scrutinizing the thoughts and actions of the past; for, memory, that faithful monitor, will sometimes carry them to occurrences which revive no pleasing recollections. When their honest thoughts are turned within, such a horrid sight meets their vision—such frightful monsters of hatefulness and deceit, of unfairness and dishonesty, in some shape, of unkindness or uncharitableness, that they cannot endure the sight. Something will come to mind which embitters their whole existence; and could it be effaced from the tablet of memory, they would willingly sacrifice all the gold of California, were it at their command. To canvass all the little acts and thoughts of the past, and to look caudily into the heart, and see what principles actuate them, what motives prompt them, and what are their most ardent desires and their cherished affections, often makes solitude a lonely, unprofitable, and a dreadful place; and unless they can mingle freely with the world, or launch deeply into business, or be overwhelmed with cares, their existence is truly miserable. But of many such it may be truthfully said:

“O lost to virtue, lost to manly thought,  
Who think it solitude to be alone!”

There is an incalculable benefit to be derived from sitting often in solitude. It *makes one better*; and it was a prominent characteristic of all the good, who have gone to the spirit world, that they sought retirement.

The holy prophets and apostles, and the holy *Redeemer*, furnish most illustrious examples of the benefits which may be derived from solitude and retirement.

It *makes one wiser*! “*Know thyself*” is a maxim as truthful as it is ancient; and it lies at the basis of true wisdom; and when an individual is accustomed to look into his own heart, and endeavor to eradicate every thing which he would not willingly unfold to the gaze of the world, there wisdom dwells. But it is far from our thoughts to say any thing in justification of an anchorite; nor should we betake ourselves to a hermitage, to shun the temptations to evil, and sinful besetments, which one must meet with in society. We are all social beings; the wise and benevolent *Creator* has endowed us with social faculties, truly eunobliug; and he who neglects their cultivation is culpable of base ingratitude towards the great *Author* of his existence, and shamefully unmindful of his own best interests.

But those who are accustomed to seek solitude, should see to it, that it does not, eventually, prove a detriment, rather than a benefit to them. Many seek retirement to only brood over imaginary troubles and trivial perplexities, and to give vent to their burdened spirits in a flood of tears. Others are so pure and irreproachable in thoughts and reputation, that they wish to tear away from all intercourse with the despicable race, to which they legitimately belong, and sit down in solitude, self-congratulated and happy in the thought that it is good to be alone, away from the proud, the haughty, and the vile. But he who seeks solitude from honest and right motives, and in its blest retreat exercises himself honestly, candidly, and wisely, as a good and wise man, and a virtuous citizen, is able to go forth into the world, undaunted and undismayed, and to meet with composure, and unruffled temper, the

ten thousand outward influences which spring up in his path to embitter life's choicest comforts.

Gentle reader, did you ever go alone by yourself, and sit down, as if you had nothing more to do in this world of care and disappointment, and meditate for a few moments? Did you ever, in solitude, where you were secluded from every mortal eye and care, turn your thoughts within, and candidly ask, and pause for a reply, “*What am I, whence came I, and whither do I go?*” If you have not, allow me to assure you that you are a stranger to one of the richest sources of enjoyment and pleasure to which mortals have access. Here, in solitude, the wayward learn to amend their ways. Here the good receive new additions to their store of excellence, and the wise and virtuous obtain more wisdom, which renders them more happy and useful to their fellow-men.

“A soul without reflection, like a pile  
Without inhabitant, to ruin runs.”

LAKE RIDGE, TOMPKINS COUNTY, N. Y.

S. E. T.

#### AN OMNIBUS YARD.

ON the main Islington road, not far from Highbury-corner, just opposite Union Chapel, there is a stable-yard, at the entrance of which there are generally two or three 'buses changing horses; a board over it denotes that it is the stabling of the London Geueal Omnibus Company. If we go up that yard, we shall find that we are in a vast square, occupying nearly twenty acres of ground, and running as far back as the Liverpool Road. To the right of us are enormous stables, each stable containing forty horses, all comfortably bedded down in straw, resting after their labors, and recruiting their strength for fresh ones. The horses do not work too hard—not more than three hours out of the twenty-four—and consume daily 18 lbs. of corn and 10 lbs. of chaff. To each omnibus (with the exception of the few drawn by three horses, which have a dozen) there are ten horses attached, which are never changed, which are all numbered, and the fullest particulars of which are entered in a book kept by the active and intelligent foreman of the yard. There is a horse-keeper to each set, who knows the times of his omnibus, and acts accordingly. In the middle of the yard is an immense shed, under which the omnibuses are drawn at night, and washed and cleaned for the next day. This washing is done very easily. An enormous tank, holding 27,000 gallons of water, supplies several tubs, against which each omnibus is placed. There is a watchman, who comes on at 9 at night, and receives the omnibuses as they come in, and ranges them in the order in which, on the following morning, they will commence their respective exits. \* \* \* Let us return to the horses. We have spoken of those in good health and in active work. Some of them are really capital cattle; and I was shown a pair of chestnuts worth at least a hundred pounds. We will now proceed to the infirmary, just premising that in so enormous a yard every precaution is taken against disease. A man is constantly at work white-washing the stables. This takes him four months; and by

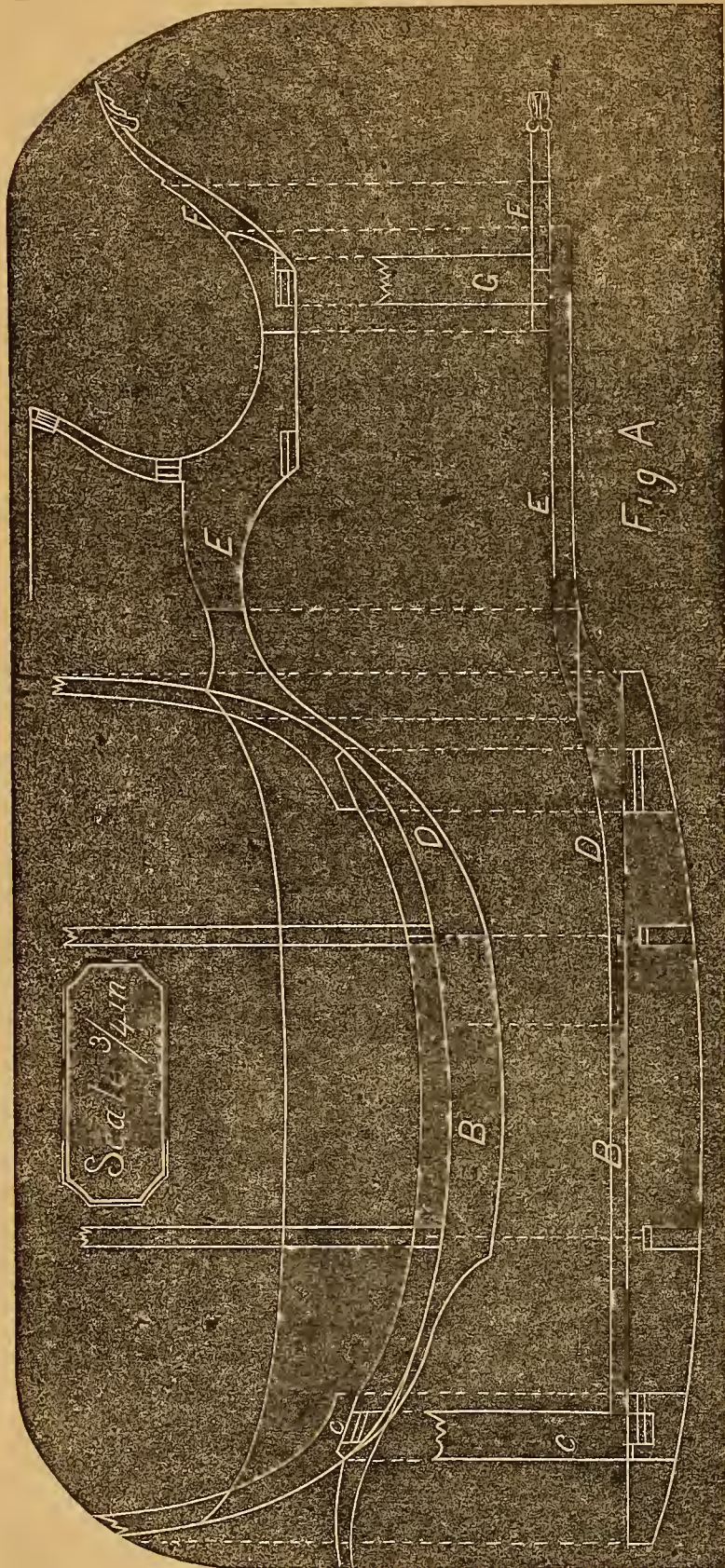

ROCKER WORK OF COACH, ON PLATE 43, VOL. I.

the time he has done, he has to commence anew. The infirm-ary consists of a series of roomy brick stables, very warm and snug, where the dumb animals are treated more tenderly than many Christians. In another part there is a large inclosure, more than half covered, but open on one side, for the recovery of the horses who—having nothing particularly the matter with them, but who have lived too fast or worked too much—re-

quire a month or two of rest. The aged and the incurable are drafted off and sent to the repository, and sold for a few pounds. Let me add, even these horses continue their philanthropic career. No longer engaged in conveying the verdant youth of the metropolis to business or pleasure, they drag greens from door to door. The shoeing forge is close by. The physicking and shoeing is taken by contract by one man. He must have enough to do, as in this yard and the one close by, are generally a thousand horses. The food, prepared by steam, is ground at the depot in Bell Lane.

For the New York Coach-maker's Magazine.

### GEOMETRY OF CARRIAGE ARCHITECTURE.

BY A PRACTICAL COACH-MAKER.

#### PART SEVENTH—BODY CONSTRUCTION.

THE accompanying diagram illustrates the construction of the rocker-work of Plate No. 43, Vol. I. of this work. It shows the thickness of timber required for each piece, and the simplest manner of splicing. Fig. A gives the lines of the rocker and swell of the body, with the concave front. The back-rocker B fits against the back-bar C, and is spliced on to the middle-rocker D, which is three or more inches thick, according to the concave required. The front-rocker E is well screwed on to the middle-rocker D, both inside and out. One and a half inches is thickness enough for the front-rocker, except at the joint, where it is screwed to the middle-rocker. The front bracket F is screwed on the inside of rocker E. The front-bar G is framed into a bracket, as seen in the diagram.

In paneling over the front-rocker E, it would be well to get your panels out a couple of days before you require them, and steam them on the concave end, and bend them on a press, to fit the concave. You can afterwards take them off the press in a day or two, and glue them on perfectly dry without any trouble. Some body-makers steam their panels and glue them on wet, which gives them a fine chance to come off again. All panels should be put on as dry as possible; and should the weather be cold, there ought to be great care taken to have all the panel-cauls, or straps, well heated when you lay them on the panels; then, when you apply the screws, the heat penetrates the panel, and warms the glue, so that the work is more perfect. As it is difficult to keep the glue from chilling in cold weather, a little care in this particular saves a world of trouble. In gluing panels on a surface, a tooth-plane should be used, or, the corner of a sharp file will answer the same purpose, since glue will adhere more firmly to a torn surface than to a smooth one.

A GERMAN writer observes that in the United States there is such a scarcity of thieves, they are obliged to offer a reward for their discovery.

## The Home Circle.

For the New York Coach-maker's Magazine.

### THE OUTLAW'S BRIDE.

A SKETCH FROM THE UNWRITTEN REMINISCENCES OF AN IRISH REBEL.

WHATEVER difficulty the reader may experience in reconciling an opening confession of precocity with the natural modesty (!) peculiar to my race and nation, truth, the "unvarnished" characteristic of my story, must not be compromised at the outset. In my nineteenth summer—to which time has since contributed an additional dozen—it was my fortune to become the victim of a twofold calamity: besides falling head and ears in love, I had earned for myself the somewhat equivocal distinction of "an Irish rebel." "The patriot's meed" is not always regulated by the standard of impartiality and justice: it may be the "laurel" or a halter, according to success or failure; and results alone, without reference to circumstances or causes, usually decide his title to the immortality of an idiot or a demigod. The failure of our insurrectionary movement of '48, had placed me in the former category.

With one fair and indulgent exception, I was but too generally branded as "a fool"—a fool, however, whose carcass, alive or dead, would have been worth a thousand dollars to "our Sovereign Lady, the Queen"—at least the representative of that sum, in the shape of two hundred pounds sterling, was publicly offered by government proclamation for the capture of my person—the uses and purposes of the said specimen of humanity being, as a matter of British "political expediency," either to adorn a Tasmanian chain-gang or a Tipperary gibbet.

Ireland—then as now, a paradise of spies, detectives, and informers—was swarming with these amiable instruments of law, order, and "civilization:" they were the indispensable agencies through which my Lord Clarendon was exerting that boasted governmental "energy" by which alone the rule of his regal mistress could be perpetuated over the goodly denizens of the "Emerald Isle." John Mitchell was already beguiling his tropical captivity under the guns of Bermuda, with about the fourth chapter of his *Jail Journal*: and the judicial drama of Clonmel—eventuating in the penal exile of O'Brien, Meagher, and certain of their political *confrères*, to the jungles of Tasmania, was upon the eve of its enactment. O'Gorman, Dillon, Doheny (late colonel of the 69th regiment), and a host of others, more or less prominently connected with the hazardous events of the time, had fortunately defrauded the dungeons of their prey, and the convict-ships of so many living items prematurely enrolled upon their respective bills of lading: luckily for themselves, they had effected an escape from the scene of baffled hopes and political abortions: like hope-forsaken mariners plunging from some sinking wreck, they had cast themselves "upon the waves of the world," leaving the old ship to creak beneath the tramp of the buccaners of England—her flag still flying, it is true, but its indications were those of "a vessel in distress"—the spectacle was not yet—perhaps it never shall be—of

"The green above the red."

Many had escaped. New York became the principal *refugium peccatorum* of the crowd. Great was the consequent jubilation in that virtuous city; but in Ireland there was grievous disappointment among jailors and hangmen,

and a wonderful diminution of prospective shipments to the South Pacific.

But the hegira was incomplete! A few still remained behind and at large; and upon these a "maternal government" was determined to concentrate its partially baffled vengeance. From day to day, and from centre to circumference of the island, "the hue and cry"—that orthodox gospel of the detective—duly chronicled their respective descriptions, names, and avocations, and mine was honored with a place among the number.

"No. 2, ———, 19 years of age—five feet seven—slender make—broad shoulders—very erect—light agile step—mild girlish face—brown eyes—hair a little sandy—soft mellow accent," &c., &c., &c.

I am not sure that, at any time, my vanity would have been equal to a full appreciation of this tickling daguerreotype; but certain it is, that, in the eyes of the original, the fidelity of the resemblance derived but little additional value from the circumstances that produced it.

There I was—"No. 2" upon the list—age, height, limb, and lineament, with two hundred pounds sterling set against my name, as the reward of the first miscreant who might be so lucky as to make me the "Queen's prisoner," and as such to hand me over to the tender mercies of "Her Majesty's law officers of the crown," a "packed jury," and a suspended habeas corpus! The island—as already intimated—was literally swarming with the subordinate harpies of the law, while its birds of richer plumage—in the shape of judges, attorneys-general, and so forth—were hovering upon the wing, ready to swoop down from their high places, and to delve, beak and talons, into the vitals of any thing in "rebel" form which the tribe of inferior feather might be able to secure as their legitimate prey. Banned and branded as a "rebel"—a horde of loyal blood-hounds upon my track—an outlaw upon my native hills, the vultures of "the mother country" croaking and screaming in the wild gorges beneath and around me, and all human possibility of escape apparently excluded—all this for having "rebelled" against the crown and dignity of a certain potentate in petticoats, as a pikeman, and what was still worse, as a poet—was enough—combined with a still more tender claim upon her sympathies—to insure to me the unswerving devotion of at least one "kindred spirit" in the youthful and ardent heroine whom it now becomes necessary to introduce. She, too, was a "rebel!" At least if it were rebellion to have familiarized her young soul with the story of her country's wrongs—to interpret its revelations by the dim light of Ireland's old historic glories—to share the inspiration of the living bards who were then inserting tongues of fire in the bleeding wounds of her native land,

"Waking up some ancient story,  
From each prostrate shrine or hall,  
Old traditions of a glory  
Earth may never more recall!"

If to consecrate her opening life, its aims and aspirations, to the sacred cause of her land's redemption, with a devotion only second to that which she owed to her God—if that constituted the crime of "rebellion," there was not a more rebellious heart in Ireland, than that which throbbed within the bosom of Caroline O'Grady. The songs of Sappho would have but feebly breathed the impassioned soul of Caroline, uniting, in its sanctified recesses, the kindred flames of a fathomless affection and a burning patriotism. Such was she who had lent its first inspiration to one fiery muse, which had evoked the vengeance of the British

lion, by its appeals to the pride and daring of the old land, through the thrilling pages of *The Spirit of the Nation*—that muse was mine!

Caroline O'Grady was my cousin. In what degree of that relationship it is unnecessary to explain. And, strange coincidence! if the chronicles of maternal memory did not err, we first saw the light upon the same day; and, as if still closer to identify in its circumstances the initiation of our earthly career, we received together, and at the same font, the sprinkling of the baptismal water.

The gambols of our childhood, the pastimes of our youth, and, in their turn, the pursuits of intellectual culture (which with both of us became a passion)—these, with intermissions "few and far between," we enjoyed together; no wonder that, as a consequence against which no human provision could have availed, the result was one of those instances of early mutual attachment, whose origin and progress leave neither stain nor sorrow to darken the future development of its maturity and power. Such was our love and the associations from which it sprung: now came the trials which were to test its depth and mystery!

Six weeks had passed over since the ruin of an ill-starred cause had left me a fugitive among the mountain fastnesses of Tipperary, an outlaw upon the hills that still overlook my native valley of the Suir. To me that valley, with its bloom and beauty, its rushing river, the home of Caroline, —but why dwell upon the scene or its associations?—to me that valley was an interdicted Eden, guarded by the flaming sword of British vigilance. True that, amidst the wild intricacies of my savage retreat, with the agility of a mountain beagle, an unyielding spirit, a case of pistols, and a trusty pike, I had little to fear for my immediate personal liberty, except, indeed, at a price which would have furnished the Galtee traditions with the materials for a tragic episode. But to continue such an existence was impossible. My position, with all its embittering humiliations and maddening memories, was far less enviable than that of the most war-worn soldier,

"Upon whose ear the signal word  
Of strife and death is hourly breaking,  
Who sleeps with head upon the sword  
His fevered hand must grasp in waking."

To escape, even if I would, were impossible. Escape would have been but another name for separation from all I desired to cling to upon earth, and I felt chained to the spot by the spell of a terrible fascination. \* \* \*

It was a clear mellow night in the latter end of autumn, and by the light of a broad harvest moon, I could distinctly trace the line of the beautiful Suir, rolling its ample volume through the valley beneath. Every feature of the scene had been familiar from my childhood, but, alas! how changed were the circumstances attending its contemplation! Yielding to the emotions which these circumstances inspired, I flung myself upon the mountain heather, in order to close my eyes to the prospect, and banish, if I could, the thousand memories which it recalled. In this bootless effort of the will, in which heart or nature had no participation, I was suddenly interrupted by the barking of a dog. In the intervals of this interruption—and still more unaccountable, in a spot which, especially at such an hour, might have been fitly dedicated to the genius of Solitude—the tones of a living voice more than once distinctly articulated my name; another instant, and the rough sward by my side was darkened by a shadow which removed all

doubt as to the presence of a human form. I started to my feet—the hour, and even the occasion, seemed made for such a meeting; like another Madame Lavalette, Caroline O'Grady had committed herself to the mission of a heroine, and her lonely adventure, and this midnight mountain scene, were the opening incidents in the romance of its accomplishment. With the first dawn of morning the mountains were to be scoured; a force of light infantry, sufficient for that purpose, had, since nightfall, been concentrated at a suitable point for the intended foray; and, guided as they were to be, by a posse of local hirelings, nothing the size of a grouse would have had the slightest chance of escape. Such, in substance, was her information; such, in reality, were the facts, as they afterwards occurred.

The morning came, the mountains were scoured; but Caroline and I were far away, never, never again, by sun or moonlight, to gaze upon our own beloved valley of the Suir, from the summit of the Galtees, the glorious background of the picture!

On the following night, as the clock struck ten, and the Galway mail, on its way to Dublin, was changing horses at Athlone—forty miles distant—a young lady, muffled in a heavy traveling cloak, with a small valise in her hand, might be seen issuing from the door of Gray's Hotel, and taking her place in the vehicle as an inside passenger. The "roof," as was generally the case with the old Irish night-mail, was thronged with "outsiders," but only two or three persons, and these soundly asleep, were stowed away within; so that our fair young stranger was enabled to enter without difficulty, and quietly to take her place without inconvenience to the pre-occupying party. At the word "All aboard!" and as the horses were just gathering themselves for the start, the approach of hurried footsteps, and a loud "Hulloa!" in a gruff Lancashire voice, announced a fresh addition to the burden of the conveyance, in the person of a stout, well-dressed man, about thirty—muffled to the eyes, and presenting, as it soon became apparent, a rather inviting subject for the suspicion and scrutiny of his fellow-travelers. He mounted to the box, and squeezed himself into a seat by the driver.

Had the young lady noticed as the occupant of another department of the vehicle, been less amused with the snoring of an old Connaught magistrate on his way to the Castle of Dublin, to lay before government an appalling account of the disaffection of his district, or had the conversation on the "roof" reached her ears with less interruption from the rumbling of the wheels and the monotonous tramp-tramp of the horses as they eagerly shortened the original fourteen miles forming their allotted task to Kilbeggan—it is not unlikely that she would have experienced the emotions of a deep personal interest in the following dialogue: "Foin noight, Mosther Coachmon—foin noight—hisn't hit?"

"A fine night, sir, but a little *dhry* for the season."

"Well, I reckon so, but the heliments are very changeable in this 'ere hoiland, and hi honly wish that your remhark may 'old good until mornin'."

"No feer of a duekin', bar'n' ye'd fancy a little inside moisthur, as Providence mightn't take well of ye to pass wid the curse of the next station."

Whether the temporary silence produced by this figurative innuendo was to be credited to downright stolidity, or an orthodox devotion to the cause of Temperance, upon the part of his Saxon neighbor, his mattered not a straw to our knight of the whip; his pride would have willingly recalled a professional advance so palpably unattended with

success; and he was now determined to avenge its failure, upon the first renewal of the conversation.

(To be continued.)

For the New York Coach-Maker's Magazine.

#### AUTUMNAL THOUGHTS.

WHILE poets are tasking their brains,  
The beauties of autumn to trace,  
And sparing no labor or pains,  
To show forth the charms of its face :

The seasons are hurrying on,  
Cold winter will soon take its place,  
The sere yellow leaf will be gone,  
With the lessons they teach to our race.

Like the leaves of the forest decaying,  
The autumn of manhood comes on,  
The cycle of years is conveying,  
Mankind to the cold silent tomb.

But a region of grandeur there is,  
Where sorrow and death do not come ;  
Where spring, with its sweetness and bliss,  
Is beck'ning us on to our home.

E. B.

### Pen Illustrations of the Drafts.

For the New York Coach-Maker's Magazine.

NAPOLEON BRETT.

Illustrated on Plate XV.

BRIDGEPORT, CONN., September 15, 1859.

THE accompanying draft is a design for a brett. The back-quarters and front-boot are new features, which give a pleasing effect and furnish a variety. This carriage painted Napoleon blue, and trimmed with blue silk goods, would look very fine for a summer turn-out.

J. IRVING.

DOG-CART.

Illustrated on Plate XVI.

THIS draft has been sent to us from Berlin by Mr. Jos. Neuss, a distinguished carriage-maker of that city. As will be observed, it makes a very pretty and compact sporting vehicle, and presents some points which may serve as hints—should it not exactly suit a present order—in getting up articles for the successors of Nimrod at this season, when such are called for. The "cut-under" is an improvement where short turning is required, and this feature might be carried still further up, if necessary. We would remind the reader that the article in imitation of the French carved mahogany, used for the side panels, is now manufactured in New York, which can be purchased considerably cheaper than the imported. The trimmings should—where frequently exposed to the weather—invariably be of leather.

SKELETON WAGON.

Illustrated on Plate XVII.

WE have recently had a number of calls for drafts of this kind, and, in order to satisfy our kind friends, we have taken some pains to prepare this. We think our draft is sufficiently correct to enable any one to construct so plain an article, when we state that a light one should not weigh

over eighty or eighty-five pounds completed. The half-sectional bird's-eye view attached, will be found very useful to those who have never made this kind of vehicle.

### Sparks from the Anvil.

#### THAT PATENT SHIFTING-RAIL.

As our readers will have learned from an article in our September issue, the coach-makers are again called upon to settle; in this case, for infringing upon the rights of certain parties for a shifting top-rail, claimed to have been patented July 15, 1851.

It is very singular, not to say reprehensible, that any patentee should get out a patent, suffer everybody to infringe upon *his* rights for eight years, without saying a word against it, and then come down upon them with the thunderings of the law, in the shape of claims for damages. We repeat that it is *very* singular, and we can give no better reason for this inaction, than by supposing that in his rambles in search of custom, our patentee must unfortunately have crossed that classic ground known as "Sleepy Hollow," and, like his illustrious predecessor, taken an eight years' nap. Be this as it may, he will find that the fraternity have become "wide awake" to this subject, and that they will not sleep until they see the thing through.

Through the kind permission of the Committee appointed by the New Haven carriage-makers to investigate this matter, we are enabled to furnish copies of such certified documents from the Patent Office, and letters and papers from other sources, as will assist the reader in forming his own judgment in regard to the validity of the pretended claims upon the coach-making public. The engravings which we are enabled to present from originals, will be found very useful in explaining the subject.

HIBBARD'S FIRST APPLICATION FOR A PATENT—REJECTED.  
*To the Commissioners of Patents :*

The petition of HARMON HIBBARD, of Henrietta, in the county of Monroe, and State of New York, respectfully represents :

That your petitioner has invented a new and improved method of applying, shifting, and managing tops on buggy seats or other vehicles, which he verily believes has not been known or used prior to the invention thereof by your petitioner.

He therefore prays that letters patent of the United States may be granted to him therefor, vesting in him and his legal representatives the exclusive right to the same, upon the terms and conditions expressed in the Act of Congress in that case made and provided, he having paid into the Treasury thirty dollars, and complied with other provisions of the said act.

HARMON HIBBARD.

Cancelled, \$20, G. W. 2d mod.

*To all whom it may concern :*

Be it known that I, Harmon Hibbard, of Henrietta, in

the county of Monroe, and State of New York, have invented a new and improved method of applying, shifting, and managing tops on buggies and other vehicles, and I do hereby declare that the following is a full and exact description.

The nature of my invention consists in the portableness and facility with which I apply, shift, and manage a top, on a seat or vehicle, by using portable bearers for the support of the top, which may be used on different seats, if made of iron or other suitable metals, by forming it to a shape to apply and fit the end of the seat on the inner side, and on the bottom with a short centre-piece, extending from the centre of each lever at right angles horizontally on the seat, sufficient in length to receive a screw through a hole in each, perforated in their centre, without interference with the support of the seat at each end, as there is a nut *screws on under the seat*, and the bearers support the whole top, and are fastened to the seat by these two screws only, as shown at A, in the drawing; the bearers then extend up over the back of the seat, close in the corner, on the ends of which is formed a notch to receive a clasp that is made of wire, and extends around the back of the seat through the notches to the points on each side of the front part of the seat, to which the bows are attached for their revolving point, as shown at C; these points bring the front end of the bearers which come up over the front part of the arms of the seat, and form not only a support for each end of the bows, but also for the clasp on which the cover terminates at the bottom, by the clasp being perforated at each end, and after passing around the rear end of the bearers, is slipped on the front ends or points over the bows on each side, and then fastened by screwing on nuts over them; then for the support of the bearers, I perforate the hindmost end of the bearers forward of the clasp or notch, in a perpendicular manner, and then insert screws to receive nuts screwed on under the bearers. These screws are also perforated through their heads, and are the only fastening of the continuous brace in the rear, as shown at B. This brace consists of a wire passed through the heads of these two screws at both hind corners of the seat, then turned at right angles forward, reaching almost half-way across the top on the inner side, then forming a joint with a piece on each end, which reaches to the front bow of the top, and is there fastened by screws which can be withdrawn during the trimming of the top. This brace continues across above the back edge of the seat, on the inner side of the top, in such a manner that the top can be thrown back or forward with little effort of the hand, while sitting on the seat.

What I claim as my invention, and desire to secure by letters patent, is the application to any seat or carriage-top, of the bearers herein described. I also claim the application of the continuous brace and single joint to any top, as herein described; also the application of the clasp as herein described.

HARMON HIBBARD.

Witnesses—M. H. MONROE.  
NATHAN HACK.

County of Monroe, State of New York, ss.:

On this third day of May, 1851, before the subscriber, a justice of the peace, personally appeared the within-named Harmon Hibbard, and made solemn affirmation that he verily believes himself to be the original and first inventor of the mode herein described for the support, portableness,

and management of carriage-tops, and that he does not know or believe the same was ever before known or used, and that he is a citizen of the United States.

JOSEPH BROWN, *Justice of Peace.*

WHEREAS, I, Harmon Hibbard, of Henrietta, Monroe county, New York, have invented a new improved method of applying, shifting, and managing tops on the seats of vehicles, as a shade or shelter, for which I am about to apply for letters patent, and whereas I have sold, and hereby do sell, assign, and give up all my right, title, and interest to or in the said invention, to Jared A. Hibbard, of the place aforesaid, for the sum of five hundred dollars, to me in hand paid, the receipt whereof is hereby acknowledged, I do consent and desire that letters patent may issue in the name of the said Jared A. Hibbard.

GIVEN under my hand and seal, this 24th day of  
[L. S.] March, 1851.

HARMON HIBBARD.

Witnesses—M. H. MONROE,  
NATHAN HACK.

[The description in the specification is not clear, partly owing to careless writing, and partly for want of sufficient references to the parts described, which must be all shown clearly in the drawing. Claim not sufficiently explicit, and is not clear; drawings are not sufficient, they]

[should show all the parts included in the claims in detail, and the specification should refer by letter to these details. This specification must be returned to the office with these remarks unerased, with the new papers furnished.]

To the Commissioner of Patents:

The petition of HARMON HIBBARD, of Henrietta, in the county of Monroe, and State of New York, respectfully represents:

That your petitioner has invented a new and improved method of applying, shifting, and managing tops on buggy-seats, or other vehicles, which he verily believed has not been known or used prior to the invention thereof by your petitioner. He therefore prays that letters patent of the United States may be granted to him, therefore vesting in him and his legal representatives the exclusive right to the same, upon the terms and conditions expressed in the act of Congress in that case made and provided, he having paid thirty dollars into the treasury, and complied with the other provisions of the said act.

HARMON HIBBARD.

To all whom it may concern:

Be it known that I, Harmon Hibbard, of Henrietta, in the county of Monroe and State of New York, have invented a new and improved method of applying, shifting, and managing tops on buggies and other vehicles, and I do hereby declare that the following is a full and exact description thereof.

The nature of my invention consists in the portableness of, and the facility with which I apply, shift, and manage a top on a seat or vehicle, by using portable bearers for the support of the whole top and cover; a continuous brace for the raising and lowering of the top, and a clasp for the support and fastening of the cover at the bottom, which clasp serves also as a rest for the top when thrown back. The bearers are made of iron or any other suitable metal, by forming it to a shaft to apply to and fit the end of the

seat on the inner-side and on the bottom, as shown in the drawing Fig. 1, at D. To the centre of each of these bearers is attached a short strip or entre-piece of the same metal as the bearers, running horizontally on the bottom of the seats towards the centre of the same, as is shown at A, Fig. 1. These centre-pieces are of sufficient length to admit a headed screw (without interfering with the support of the seat), which passes through the centre of each; then through the bottom of the seat, and is there fastened by screwing on a nut under the seat. These screws form the only fastening of the bearers to the seat and are of sufficient strength to hold the bearers firmly in their places. The hind ends of the bearers then extend up over the ends of the back of the seat close in the corners, projecting horizontally a short distance beyond the line of the back, at right angles with the same, and terminating in a small semicircle or holder, as shown at C, Fig. 2, and through which the clasp passes for its support and permanency on the back of the top. The front ends of the bearers rising from the bottom of the seats, pass up over the front ends of the arms of the seat, and project horizontally beyond them at right angles with the arms, far enough to admit the ends of the bows and clasp (which are perforated) being slipped on over them, without interfering with the arms of the seat. The clasp F, fig. 1, consists of a wire which passes across from the hind end of one bearer to the other, through the above-named semicircles or holders on the extreme ends of the bearers, and projects far enough in a straight line to clear the lines of the arms of the seat; then turns and passes forward horizontally, nearly parallel with the arms, and is flattened at both ends, and fixed on to the front ends of the bearers over the bows, and there fastened by nuts serewed on to the ends of the bearers, and to this clasp the cover is fastened for its only support at the bottom. The continuous brace G in the drawings Nos. 1 and 2, consists of an iron rod or large wire, extending across from the end of one bearer to the other, behind the seat, through the head of a screw which penetrates both of the bearers perpendicularly between the holders and the back of the seat, leaving space enough between these serews and the back of the seat to fasten them by turning a nut on to the lower end of each; the brace then turns forward, rising gradually on the inner side of the top, and forming a slight downward curve, until it reaches about half-across the end of the seat, where a joint is formed; it then extends on, still rising with a slight upward curve, until it reaches the front bow of the top, where it is fastened by coped serews and nuts.

The chief object of the clasp and bearers in my invention or the principal advantages to be gained by their application to carriage-tops and seats, over any other invention, consists in the convenience with which they may be applied and fastened to seats, and the facility with which they may be accommodated to the portableness of a top, by enabling one, with their use, to shift a top from one seat to another, or to remove a top when not needed; and also the great advantage over the common method of attaching tops to seats, in preventing much violent rocking and straining on the arms and back of seats, which advantage is gained both by the manner of attaching the top to the seat and by placing the brace near the bottom of the top; and the advantages of the continuous brace over any other, consists in its simultaneous motion in raising and lowering the top, enabling one to sit on either end of the seat and manage the top with ease, or standing on the ground to do

the same with little inconvenience; also the saving of one joint on each side, and the advantage of the low situation of the brace in the top, to prevent racking, as mentioned above. The parts of the bearers not covered by the cushions on the seat, are intended to be trimmed, and also the lower parts of the brace.

What I claim as my invention, and desire to secure by letters patent, is the mode of connecting carriage-tops with the seats, by means of bearers D, and clasp F, so that they may with facility be removed from one carriage-body and applied to another, in the manner substantially as described.

Witnesses—JOSEPH BROWN, } HARMON HIBBARD.  
NATHAN HACK. }

[Claim stricken out by order of applicant. See letter within.]

*Town of Henrietta, and County of Monroe, State of New York, ss.:*

On this 30th day of May, 1851, before me, the subscriber, a Justice of Peace, personally appeared the within named Harmon Hibbard, and made solemn affirmation, that he verily believes himself to be the original and first inventor of the mode herein described for the support, portableness, and management of carriage-tops, and that he does not know, or believe, the same was ever before known or used, and that he is a citizen of the United States.

Subscribed and affirmed to, this thirtieth day of May, 1851.  
JOSEPH BROWN, *Justice.*

[My intention and desire to secure by letters patent, is the mode of connecting carriage-tops with the ends, by means of bearers D, and clasp F, so that they may with facility be removed from one carriage-body, and applied to another, in the manner substantially as described.]

2d clause stands.

PATENT OFFICE, May 12, 1851.

SIR—Specification and drawings of your alleged improvement in buggy-tops, are herewith returned for further amendment. They do not present that clear idea of the operation of the machine, which the law requires. See inclosed circular. Respectfully yours, &c.,

THOMAS EW BANK, *Com'r.*

H. HIBBARD, Henrietta, N. Y.

No. 9195.

7th June, 1851.

In conformity to an act of Congress, entitled, "An act to promote the progress of the useful arts," approved 4th of July, 1836, I have received of H. Hibbard, Henrietta, N. Y., thirty dollars, which sum has been placed to the credit of my account in the treasury, 11 S. D. C., under the date of 8th May, 1851, and for which I have signed a receipt for a patent buggy-top.

J. SLOANE,

*Treasurer of the United States.*

Registered—MUNSON HAINES, *Register of the Treasury.*

To THOMAS EW BANK, Esq., *Commissioner of Patents:*

SIR—With gratitude I tender you my thanks for your favor, in sending me the form of claim, which I have complied with, and followed, and to which I have added a claim which I think I am entitled to, if not to the whole brace; but as your honor has the best opportunity of gathering facts, you will please consult your own feelings in regard to my persisted claim, which, if not legally practicable to admit, you will please omit, or erase, without further ceremony, and oblige,

Your servant,

HARMON HIBBARD.

[2d Claim stricken out, see *Manuel du Carrosse*, plate 7, vol. 2, and Patent to John L. Allen, January 14, 1851.]

U. S. PATENT OFFICE, June 16th, 1851.

SIR—Specification of your alleged improvements in carriage-tops is herewith returned for amendment. The claims as they now stand cannot be allowed—the continuous brace you will find in Letters Patent granted to Solomon Goddard, and Henry Warfield, for carriage-top, Feb. 19, 1850, and to John Allen for a similar invention, Oct. 15, 1850. It is believed however, that the claim suggested in pencil covers your invention, and if it be presented, that it will be allowed.

Respectfully yours, &c.,  
ROGER C. WEIGHTMAN, *Act. Com.*

H. HIBBARD, }  
J. A. HIBBARD, }  
Henrietta, New York.

THE UNITED STATES OF AMERICA.

No. 8222.

To all to whom these Letters Patent shall come:

WHEREAS, HARMON Hibbard, of Henrietta, N. Y. has alleged that he has invented a new and useful Improvement in Buggy Tops (he having assigned\* his whole right, title, and interest in said invention to Jared A. Hibbard, of Henrietta, aforesaid), which he states has not been known or used before his application, has made affirmation that he is a citizen of the United States, that he does verily believe that he is the original and first inventor or discoverer of the said improvement, and that the same hath not, to the best of his knowledge and belief, been previously known or used; has paid into the Treasury of the United States the sum of thirty dollars, and presented a petition to the Commissioner of Patents, signifying a desire of obtaining an exclusive property in the said improvement, and praying that a patent may be granted for that purpose.

These are therefore to grant, according to law, to the said Jared A. Hibbard, his heirs, administrators, or assigns, for the term of fourteen years from the fifteenth day of July, one thousand eight hundred and fifty-one, the full and exclusive right and liberty of making, constructing, using, and vending to others to be used, the said improvement; a description whereof is given in the words of the said H. Hibbard, in the schedule hereunto annexed, and is made part of these presents.

In testimony whereof, I have caused these Letters to be made patent, and the seal of the Patent Office has been hereunto affixed.

GIVEN under my hand at the city of Washington, this fifteenth day of July, in the year of our Lord one thousand eight hundred and fifty-one, and of the Independence of the United States of America, the seventy-sixth.

ALEX. H. H. STUART,  
*Secretary of the Interior.*

Countersigned and sealed with the }  
Seal of the Patent Office. }

R. C. WEIGHTMAN,  
*Acting Commissioner of Patents.*

\* A copy of the assignment made previous to this application, together with J. A. Hibbard's subsequent assignment to George S. Hanes and Perry S. Handy, will be found on page 92.—ED.

THE SCHEDULE REFERRED TO IN THESE LETTERS PATENT AND MAKING PART OF THE SAME.

To all whom it may concern:

BE it known that, I, Harmon Hibbard, of Henrietta, in the county of Monroe, and State of New York, have invented a new and improved method of applying, shifting, and managing tops on buggies and other vehicles, and I do hereby declare that the following is a full and exact description thereof.

The nature of my invention consists in the portableness of, and the facility with which I apply, shift, and manage a top on a seat or vehicle, by using portable bearers for the

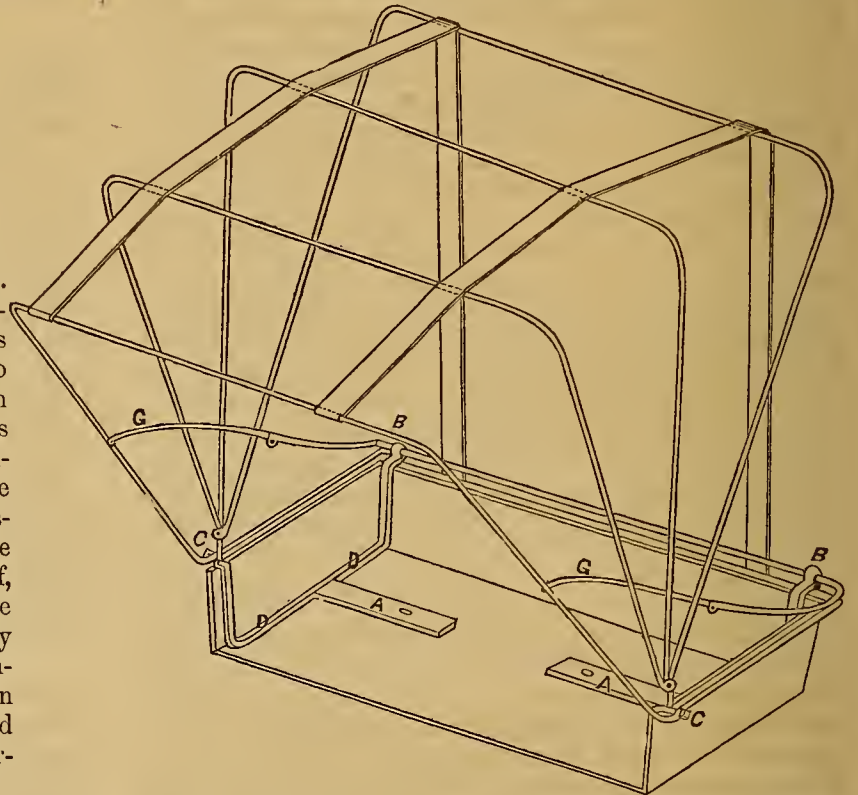

support of the whole top and cover, a continuous brace for the raising and lowering of the top, and a clasp for the support and fastening of the cover at the bottom; which clasp serves also as a seat for the top when thrown back.

Fig. 1.

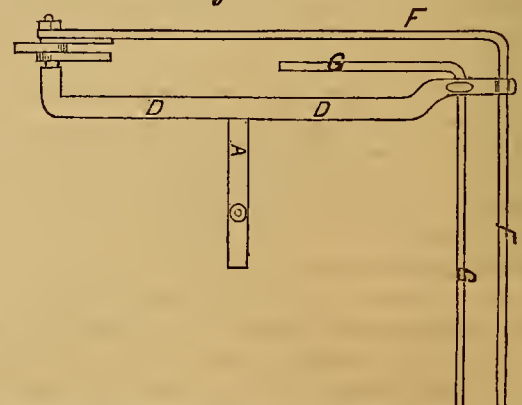

The bearers are made of iron, or any other suitable metal, by forming it to a shape to apply to, and fit the end of the seat on the inner side and on the bottom, as shown in the drawing Fig. 1 at D. To the centre of each of these bearers is attached a short strip, or centre-piece of the said metal, as



the bearers running horizontally on the bottom of the seat towards the centre of the same, and is shown at A, fig. 1. These centre pieces are of sufficient length to admit a headed screw (without interfering with the support of the seat), which passes through the centre of each; then through the bottom of the seat, and is there fastened by screwing on a nut under the seat. These screws form the only fastening of the bearers to the seat, and are of sufficient strength to hold the bearers firmly in their places. The hind end of the bearers then extends up over the ends of the back of seat, close in the corners, projecting horizontally a short distance beyond the line of the back, at right angles with the same, and terminating in a small semicircle or holder,

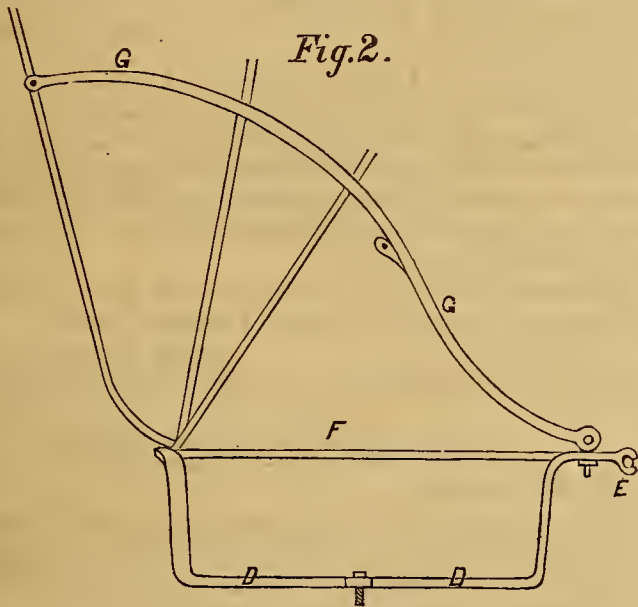

as shown at E, fig. 2; and through which the clasp passes for its support and permanency, on the back of the top. The front ends of the bearers rising from the bottom of the seat, pass up over the front ends of the arms of the seat, and project horizontally beyond them at right angles with the arms, far enough to admit the ends of the bows and clasp (which are perforated) being slipped on over them, without interfering with the arms of the seat. The clasp F, fig. 1, consists of a wire which passes across from the hind end of one bearer to the other through the above-named semicircles or holders, on the extreme ends of the bearers, and projects far enough in a straight line to clear the lines of the arms of the seat, then turns and passes forward horizontally, nearly parallel with the arms, and is flattened at both ends, and fixed on to the front ends of the bearers, over the bows, and there fastened by nuts screwed on to the ends of the bearers, and to this clasp the cover is fastened for its only support at the bottom. The continuous brace G, in the drawings Nos. 1 and 2, consists of an iron rod or large wire, extending across from the end of one bearer to the other, behind the seat, through the head of a screw which penetrates both of the bearers perpendicularly between the holders and the back of the seat, leaving space enough between these screws and the back of the seat to fasten them, by turning a nut into the lower end of each; the brace then turns forward, rising gradually on the inner side of the top, and forming a slight downward curve, until it reaches about half-across the end of the seat, where a joint is formed. It then extends on, still rising with a slight upward curve, until it reaches the front

bow of the top, where it is fastened by capped screws and nuts.

The chief object of the clasp and bearers in my invention, or the principal advantages to be gained by their application to carriage-tops and seats, over any other invention, consists in the convenience with which they may be applied and fastened to seats, and the facility with which they may be accommodated to the portableness of a top, by enabling one with their use to shift a top from one seat to another, or to remove a top when not needed, and also the great advantage over the common method of attaching tops to seats, in preventing much violent reaching and straining on the arms and back of seats, which advantage is gained both by the manner of attaching the top to the seat, and by placing the brace near the bottom of the top; and the advantage of the continuous brace over any other, consists in its simultaneous motion in raising and lowering the top, enabling one to sit on either end of the seat and manage the top with ease, or standing on the ground to do the same, with little inconvenience; also the saving of one joint on each side, and the advantage of the low situation of the brace in the top, to prevent racking, as mentioned above. The parts of the bearers not covered by the cushions on the seat, are intended to be trimmed, and also the lower parts of the brace.

What I claim as my invention, and desire to secure by letters patent, is the mode of connecting tops with the seats by means of bearers D and clasp F, so that they may with facility be removed from one carriage body and applied to another, in the manner substantially as described.

HARMON HIBBARD.

Witnesses—JOSEPH BROWN,  
NATHAN HACK.

May 12, 1851.

June 16th, 1851.

No. 8,222-3.

H. Hibbard, assignor to Jared A. Hibbard, both of Henrietta County, State of New York.

BUGGY TOPS.

Received May 8th, 1851.

Petition, “

Affidavit, “

Specification, “

2. Drawing, “

Model, “

Cert. dep., “

1. Cash \$30.

Examined Cooper, June 28, 1851.

2. Issue R. C. W., June 30, 1851.

Patented July 15, 1851.

3. Recorded vol. 45, page 217.

Address J. A. H.,  
Henrietta, N. Y.

B. on.

THE UNITED STATES PATENT OFFICE.

To all persons to whom these presents shall come:

GREETING:

This is to certify that the annexed is a true copy of letters patent issued to J. A. Hibbard, July 15, 1851.

In testimony whereof, I, S. T. Shugert, Acting Com-

[L. s.] missioner of Patents, have caused the seal of the Patent Office to be hereunto affixed this 6th day of August, in the year of our Lord one thousand eight hundred and fifty-nine, and of the Independence of the United States the eighty-fourth. S. T. SHUGERT.

THE UNITED STATES PATENT OFFICE.

To all persons to whom these presents shall come :

GREETING :

This is to certify that the annexed are true copies from the files and records of this Office, of all papers found on file and record, with the exception of the patent as granted in the application of H. Hibbard, assignor, to J. A. Hibbard, for a patent for a buggy-top, which application was filed in this office, May 8th, 1851, and was patented July 15, 1851, the copies showing the erasures, interlineations, and marginal and other notes, in ink and pencil, as they appear in the original.\*

In testimony whereof, I, S. T. Shugert, Acting Commissioner of Patents, have caused the seal of the Patent Office to be hereunto affixed, [L. s.] this 8th day of August, in the year of our Lord one thousand eight hundred and forty-nine, and of the independence of the United States the eighty-fourth.

S. T. SHUGERT.

HARMON HIBBARD'S ASSIGNMENT TO JARED A. HIBBARD.  
K<sup>2</sup> 123.

WHEREAS, I, Harmon Hibbard, of Henrietta, in the county of Monroe, and State of New York, have invented a new and improved method of applying, shifting, and managing tops on the seats of vehicles as a shade or shelter, for which I am about to apply for letters patent of the United States, and whereas I have sold, and do hereby sell, assign, and give up all my right, title, and interest to or in the said invention, to Jared A. Hibbard, of the place aforesaid, for the sum of five hundred dollars, to me in hand paid, the receipt of which is hereby acknowledged, I do consent and desire that letters patent in the name of the said Jared N. Hibbard.

Given under my hand and seal this 24th day of March, 1851.

[SEAL.] HARMON HIBBARD.

Witness,  
M. H. MONROE.

Received and Recorded June 5, 1851.

JARED A. HIBBARD'S ASSIGNMENT TO GEORGE S. HANES & PERRY S. HANDY.

To all to whom these letters patent shall come :

WHEREAS, Harmon Hibbard, of Henrietta, New York, has alleged that he has invented a new and useful improvement in buggy tops (he having assigned his whole right, title, and interest in said invention, to Jared A. Hibbard, of Henrietta, aforesaid);

And whereas, I, Jared A. Hibbard, of Henrietta, in the county of Monroe, and State of New York, did obtain letters patent of the United States, for certain improvement in-buggy tops, which letters patent bear date the fifteenth

\* The matter inclosed in brackets in this copy, is that in pencil referred to.—Ed.

day of July, 1851; and whereas George S. Hanes, and Perry S. Handy, of the towns of Yates and Ridgeway, in the State of New York, having received and fully considered said improvement, are desirous of obtaining an interest therein;

Now, this indenture witnesseth, that for and in consideration of the sum of eight hundred dollars, to me in hand paid, the receipt of which is hereby acknowledged, I have assigned, sold, and set over, and do hereby assign, sell, and set over, unto the said G. S. Hanes and P. G. Handy, all the right, title, and interest which I have in the said invention, as secured to me by the said letters patent, for, to, and in the United States of America, excepting the county of Seneca, and the town of Wheatland, and in the State of New York, and the county of Huron, in the State of Ohio;

The same to be held and enjoyed by the said G. S. Hanes and Perry S. Handy, for their own use and behoof, and for the use and behoof of their legal representatives, to the full end of the term for which said letters patent are or may be granted, as fully and entirely as the same would have been held and enjoyed by me, had this assignment and sale not been made.

In testimony whereof, I hereunto set my hand, and affix my seal this twenty-second day of February, 1851.

[SEAL.]

JARED A. HIBBARD.

Received 30th March, and recorded 7th April, 1855.

OFFICE OF THE SCIENTIFIC AMERICAN PATENT AGENCY,  
Washington, D. C., Aug. 5, 1859.

MR. H. H. DIKEMAN :

Dear Sir—Agreeably to your request, we have carefully examined the Records of Assignment in the Patent Office, and were unable to find the assignment spoken of, as being from Messrs. Hanes & Handy to Messrs. G. & D. Cook & Co., and the clerk in charge (Mr. Guest) informed me that no such assignment had been received up to to-day.

We have found but two assignments, of which you have the copies.

Respectfully, &c.,

MUNN & Co.

per G. T. ALTEE.

The Circular addressed to the members of the craft (printed on page 70) by the Secretary, Homer H. Dikeman, Esq., has elicited the following correspondence, which cannot be otherwise than interesting at this time. They go to prove that which everybody knew before, that shifting-rails are at least twenty years in use.—Ed.

PLAINSVILLE, CONN., AUG. 6, 1859.

MR. H. H. DIKEMAN :

Dear Sir—I have a man at my right hand this morning, who can take his oath that he ironed a shifting-top rail seat, twenty-one years ago, for Messrs Collis & Lawrence, New Haven, Conn.

I am, yours truly,

E. W. WEBSTER,

per JOHNSON.

NEW YORK, August 6th, 1859.

H. H. DIKEMAN, Esq. :

Dear Sir—I have received a circular, signed by a Committee of Coach-makers, in regard to the shifting-top patent.

I beg to say, that the idea of any one at this late day starting such a thing, is supremely ridiculous. You will have no difficulty in defending the patent successfully. I made them here at 27 Canal street, in 1841 and 1842, and also have plenty others. They were used *here* several years before they were adopted by the New Haven people. I can get you a plenty of depositions, if you wish.

It is my opinion that Thomas Cook, of New Haven, used the shifting-rail on his Stanhope Phaetons, as long ago as 1840; also Isaac Mix & Sons, and Brewster & Collis. Mr. Collis would know. A blacksmith by the name of Plumb, or Downs, might know, although they worked on heavy jobs.

I see the patent is dated 1851, but understand the caveat was filled some time before. If you send for depositions, make it to date, or have it stated that they were made or in use before the caveat, so that I may get some proof for you; that is, I mean, not too far back, or too far back of said caveat, for there are only two or three makers here who manufactured work over eleven or twelve years back, on that particular kind requiring shifting-tops.

Respectfully yours,

JAMES B. BREWSTER,  
786 Broadway.

NEWARK, N. J., August 8th, 1859.

H. H. DIKEMAN, Esq.:

*Dear Sir*—We we received your circular in regard to the so-called patent shifting-top rail. We have made some inquiry in reference to it. Ambrose Howell, a dash and railing-maker here, says he has made them over twenty years for buggies, shifting-rails for dashes, and two-wheeled buggies, some twenty-seven years. There is a part of a shifting-rail in Quimby's that came off of an English two-seat carriage, that has been made a great while, which they will probably write you about. The carriage-makers in this place do not feel any uneasiness about the matter. Any further information about it, we will let you know. \* \* \*

Respectfully,

DOUGLASS & POST.

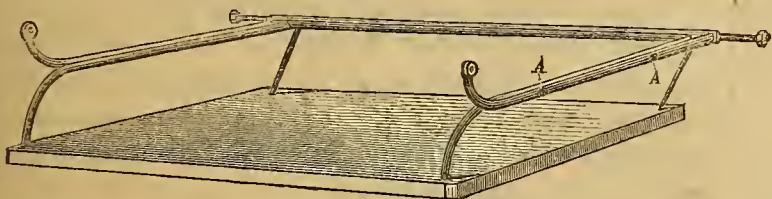

THE SHIFTING RAIL OF 1838-9.

A A in the engraving indicates the places where thumb-screws secures the shifting-rail to the seat-rail. Two at the back, and the same number on the opposite side—six in all—complete the fastenings.—Ed.

PLAINVILLE, August 9, 1859.

I, Horace Clark, of Plainville, in the town of Farmington and State of Connecticut, do hereby certify, that in the year eighteen hundred and thirty-eight or nine, when in the employment of Collis & Lawrence, of New Haven, did iron a shifting-seat after the pattern of the model accompanying this certificate, as near as I can remember, certainly after this plan.

Personally appeared Horace Clark, and under oath, certified to the foregoing certificate.

TITUS H. DARROW, *Justice of the Peace.*

YORKVILLE, N. Y., August 11, 1859.

H. H. DIKEMAN, Esq.:

*Dear Sir*—On examining my *old books*, I find an order for a *shifting-top* wagon, which was finished and delivered June 25th, 1842. If this information will be of any benefit to your friends, you have my consent to use it.

Yours truly,

JNO. C. PARKER,  
per TROY.

Mr. Isaac Mix, under date of August 15, 1859, furnishes evidence that Thomas Mix in 1831 built a carriage for Jerry Coster, of New York—John Coster and Martin Van Buren bought this second-hand, and that said Thomas Mix saw this same carriage in Hudson nine or ten years ago, and thinks that possibly Mr. Van Buren may have it yet. Isaac Stevens, of New Haven, ironed them in Fair street, and can tell all about how it was done.—Ed.

PLYMOUTH, CONN., August 16, 1859.

Mr. H. H. DIKEMAN:

*Dear Sir*—The circular of your Committee bearing date August 13th, we have received. In reply say, Mr. Comstock and ourselves are among those who have settled. \* \* \* There is considerable mystery to us about this matter, and we hope the truth will come to light.

Mr. Calvin Perkins, Senior, of this place, who has for many years made various parts of the iron work to buggies, is ready to testify that "shifting tops" were made more than twenty years ago, when he was at work in Fairfield. His evidence must be of some importance.

Yours respectfully,

J. BLAKESLEE & SON.

## Paint Room.

### HOW TO PAINT A BUGGY—ANOTHER MODE.

ALREADY, in this work, we have presented two different modes of painting a Buggy. We present a third, very briefly, which is that followed by most painters in New York City.

#### THE BODY.

First give the job four coats of lead color, each properly rubbed down, after which use four coats of English filling, an article prepared to take the place of "rough stuff." When sufficiently hard, rub all down, and give one coat of lead; then when dry, putty and face all down. Then one coat of common black in oil; one of best black; then two coats of color and varnish; afterwards two coats of varnish—one American, the other English. The hints about varnishing in another part of this volume should be heeded in putting on the last coat, if you would avoid the risk of its pitting.

#### HOW TO PROCEED WITH THE CARRIAGE.

Having given the running gear two coats of lead as directed on page thirty-two, next spread on a coat of common refined black; after this, one coat of patent black; then, a coat of Harlan's English Japan black; after this

again, a coat of English varnish. Of course, the painter will understand that there is some preparation necessary between these coats, for the next.

#### ORNAMENTAL SCROLL FOR PAINTING.

It has become quite fashionable in many sections of the country, to paint some kind of a scroll on the panels and other parts of a wagon. We intend, occasionally, to furnish such designs as may be suitable for this purpose, which can be transferred to tissue paper from our engraving, by laying it over it and tracing it with the pencil. For the convenience of reference, we shall number them.

No. 1 is from an original design furnished by Mr. H. D. Moore, of Watertown, N.Y., who gives the following instructions in relation to painting it:

Paint the circular scrolls flesh color, and give the same a second coat, and while it is yet "tacky," shade with raw sienna. Paint the scrolls on each

end, beyond the circles, in the same manner, with green, shading with dark-green and asphaltum. These remarks are not to be understood as arbitrary, for it is expected that the workman will exercise his own judgment and taste in the matter. We feel that furnishing the design is about all that may be expected of us, and that the "instructions" are but gratuitous.

S.

#### DRYING OIL.

OLD linseed oil, if mixed with protoborate of manganese in the proportions of an ounce to the gallon of oil, and kept in a close vessel for two days, exposed to a heat of 212° Fah. in a steam-bath, and frequently stirred during that time, makes a beautiful drying oil for paints. Dr. J. Hoffman, the eminent German chemist, says: "It becomes by this treatment of a clear greenish yellow color; remains thin even when cold; and zinc white paint mixed with it, dries in twenty-four hours."

## Trimming Room.

### EXPLANATION OF STITCHING PLATE F.

*Drawn from the designs of various Correspondents.*

No. 1 is a design for a full centre-piece for the side of a buggy boot.

No. 3 is the half-figure of a design as above.

No. 2 is a very pretty design for the raised plaits of the fall to a buggy-seat.

No. 4 is an original design for cushion-fronts.

No. 5 is designed as an ornament for the caps of bows.

No. 6 will be found suitable for either the back-valance of tops, the sides above take-off curtains, or the fronts of cushions.

It will be seen that we continue to give designs for stitching, but we wish it to be distinctly understood that we do so, not because it is the universal practice in New York to use them, but because they are called for by our country friends. As previously intimated, much of the ornamental stitching in New York City is done in black, and very frequently it is only the centre-piece to the boot that is stitched in white, at all. A well painted and fine job, in our opinion, is never improved by being crowded full of white stitching. The stitching-machine has done more to keep it in fashion than any thing else. By the way, we have a very fine Singer's Machine that cost us \$152, which we will dispose of, as we have no use for it, for \$130. It is a first-class and fine article that has never been used, and is a bargain to any person in want of it. These are the best yet invented—so say those who are using them.

### BUGGY BOOTS, &c.

WE notice that, instead of leather, the boots of most of the fine buggies finished in New York, are now paneled and painted very finely in black, and nicely finished with a flowing coat of English varnish. They possess some advantages over leather, in that they can be repainted, and made to look as good as new, when soiled by usage. There are many objections to the leather boot, and it is a matter of surprise that they should ever have found favor in the minds of a practical people such as Americans claim to be.

*RF* The shifting rail matter has crowded so hard upon our space that we have reluctantly been obliged to lay over some interesting communications designed for this department of our Magazine, until our next number.

BLACK JAPAN VARNISH can be made thus: Fuse by a gentle heat twelve ounces of amber and two ounces of asphaltum; then add two ounces of black rosin and half a gallon of boiled oil; mix well, remove it from the fire, and when nearly cold, add three quarters of a pint of spirits of turpentine; mix well together.

## The New York Coach-Maker's Magazine.

OCTOBER 1, 1859.

E. M. STRATTON, Editor.

### TO READERS AND CORRESPONDENTS.

**PUBLISHER'S NOTICE.**—As the conductor of this Magazine is determined to make it as useful and interesting as possible, a general invitation is given to all in the different branches of the profession, to contribute to the different departments of the work, such improvements or new features as they may be cognizant of, anywhere in the United States, and when such matter is charged (if used) it will be liberally paid for. We hope that none will be deterred from writing or sending us sketches, under the impression that they cannot write well enough. We take it upon ourselves to properly see to that matter, under the conviction that the purest ore is often found imbedded in the most unsightly rubbish. The craft will much oblige us, if, when patentees call upon them, they would point out to them the superior advantages this work offers for placing their inventions before the craft. In this way much can be done in furthering the objects of this publication.

☞ All letters directed to this office on business, NOT relating to the Magazine, but solely for the writer's benefit, must inclose a stamp; if requiring an answer, two red stamps. Orders for a specimen number must be accompanied with nine three-cent stamps. When these terms are NOT complied with, no attention will be given them.

S. T., OF N. H.—We expect that when a favor is asked of us to be done *gratuitously*, that we shall at least be reimbursed the costs your letters impose. We shall not comply until you carry out our instructions. Every letter we get from abroad costs us two cents, and, of course, the answer taxes us three cents more. These five cents, often repeated, where correspondence is as extensive as ours, costs "a sight" during the year.

J. G. H., OF ILL.—We have complied with your wishes.

R. F., OF O.—We cannot take subscribers for a less term than one year.

N. S. M., OF PA.—Very glad to find that you are pleased with the Magazine, and trust that you will recommend it to others.

T. L., OF N. Y.—Your magazines have been regularly mailed.

R. M., OF N. J.—All the back numbers, from the commencement, may still be had. The volumes commence with the June numbers annually.

S. S., OF VT.—The circular sent you contained the notice that specimen numbers were charged twenty-five cents. We have been compelled to adopt this rule to save ourselves from impositions.

G. N. B., OF ALA.—We had supposed you had had the name-plates six weeks ago. The manufacturer said he had sent them. We will attend to the matter.

J. H. P., OF C. W.—We have never experienced any trouble where postage is prepaid, and are inclined to think you are mistaken.

### CARRIAGE PATENTS.

THE present is by general consent allowed to be an age of new discoveries; but to ascertain who was the *original* discoverer of some parts of the carriage, would puzzle the "oldest inhabitant." Questions of this kind, in some instances, have become very complicated from long and general use, when narrowed down to a point. Luckily for the craft, in the case of the shifting-rail, *that* is an exception. The patent on which one of the craft in New Haven has been sued,

and others threatened with suits, has been in use—or at least the shifting-rail has been—for about sixteen years in New York City, or eight years previous to the date of Mr. Hibbard's patent. In order to speak intelligibly upon this subject, and to do justice to all, we have taken a little trouble—had our other duties permitted, we should have extended our researches—to examine the order-books of some of the older light-carriage-builders in this city.

The first was that of Mr. Jos. H. Godwin, of 114 Elizabeth street, where we found, with the names of those for whom they were built, shifting-tops ordered under dates of Feb. 4, 1843; July 24, 1844; June 6th, 1845; March 3d, 1846; and May 25, 1846, and continued down to the present time. The remarks accompanying other orders, as "to be close or stationary tops," &c., all go to show that shifting-tops were generally in use.

From an inspection of that of the late lamented Mr. Isaac Ford, who was the first to engage extensively in light work, we find an order from Fred. Schucharat, 81 Nassau street, for a take-off top, Sept. 12, 1843. We also found the following order: "Mr. Hancock, square wagon, very light, shifting-top, with wings," dated May 24, 1844. We made them ourselves some time before this patent was obtained. But we think we have said enough to settle the invalidity of the shifting-rail patent.

The next question is, How do the claimants of other men's inventions, obtain their patents, and swear that they verily believe themselves the inventors? Let us suppose a case. Some years previously, some industrious and modest mechanic applies to some part of a carriage some new and useful improvement, for which he never thought of taking out a patent from the Government; but quietly pursued the even tenor of his way, leaving *his* ingenuity as a legacy to mankind. Some thick-skull, who has no inventive genius about him, but just perception enough to see that his neighbor's labors are patentable, secretly goes to Washington with his "application," and succeeds in obtaining a patent to which he has made oath he is entitled, as the original inventor. It is true, perhaps, that his "success" is published in some scientific journal, but the circulation of it scarcely extends to six coach-makers in the land; consequently these "alleged inventions" are liable to be infringed upon, in a country so extensive as ours. Having obtained this patent, he afterwards lets it sleep, since he has not the business tact to make it generally known, or to *persuade* the public that it is "an improvement;" so the public, in its ignorance of any infringement being done, are left in its free use, until in an evil hour they are startled by the sight of a United States marshal.

Again, we will suppose that some obscure but honest-intentioned individual in "the rural districts," gets into his head some vague ideas, of something he has had intimated to him as possible to be done, and there nurses *that* idea until he verily believes he is an inventor, under which

hallucination he applies for a patent, but in such "muddled" phraseology, that the officials at head-quarters, who are not supposed to know much "anyhow," are themselves obliged to come to the rescue, or else lose the spoils of office. During the *transformation* state of *his* ingenuity, he is imbibing the idea that he is born an inventor, so that it is no wonder that by the time his parchment is received, he has become so inflated with his fame as an inventor, that he seeks no higher benefit. Here the matter rests for the present. In both these cases, the results to the public are the same.

It has been more truthfully than elegantly said, that "that which is everybody's, is nobody's business." So in regard to patents. In many cases we have found a patent obtained of a certain specification, and afterwards modified by degrees, until the original specifications are "nowhere." From this *fog* of some ten seasons is engendered a storm which bursts upon the head of some poor coach-maker, who finds trouble enough incident to his business, without those from without. He now finds that what every one supposed was free to use, is secured to some individual. Afterwards comes an expensive law-suit, which compels him to go to great expense and trouble to untie the Gordian knot that some Phrygian has leisurely taken years to tie, in "hitching his chariot to the yoke." Happy is that Alexander who even succeeds in cutting it.

With no personal allusion to any individual, these remarks have been forced upon us by recent events. The only way in which these exigencies can be successfully met, is in the formation of a general Coach-makers' Society for the protection of its mutual interests, and in a liberal support to a Magazine which chronicles every patent which is taken out for improvements in carriages, at Washington.

## CARRIAGE-MAKING IN THE VICINITY OF NEW YORK.

### A VISIT DOWN THE BAY.

Not many days since we had occasion to pay a visit down the New York bay, by steamer to Keyport, in the State of New Jersey, near which we found that carriage-making is carried on very extensively. The views of objects of interest in the passage through this, one of the noblest harbors in the world, of public and private edifices that thickly bestrewed the shores, are enough to make any American feel proud of his country. Added to these, the shores of Long and Staten Islands present to the lover of nature some of the most charming spots imaginable. South of Staten Island, and far up in the bay which washes the eastern shore of New Jersey, is situated Keyport, the landing-place of our visit, famous as being one of the places from which the "friends of good oysters" in New York are supplied with the choicest bivalves.

On landing, a short ride by stage takes the traveler to

Middletown Point, a village of about fifteen hundred inhabitants, and to the extensive carriage-manufactory of the Messrs. Craig, Reid & Burk, which establishment employs about forty-two hands, and furnishes some of the finest work for the New York market, and which we understand is frequently sold as being city made. This place is quite a pleasant one, and its sea breezes are very agreeable to the lungs of such as are constantly confined to the noxious vapors of pent-up cities.

We found Mr. Burk, one of the firm, a very agreeable gentleman, who placed us under many obligations for his kindness in furthering the objects of our visit. Mr. Curran will also accept our thanks for his valuable assistance in forming a club in this shop.

One mile and a half in another direction took us to Mechanicsville, to the shops of the Messrs. Carharts. Our friend Timothy, who is at the head of the largest factory in the place, is an enterprising man. The buildings which he occupies are well calculated for doing an extensive business, which, we are pleased to learn, he finds from experience are none too large. In this shop we found many warm friends to our enterprise the past year, but this year we have a still larger number. In fact, the reception we met with at this place will never be forgotten while memory lasts. May the "boys" never want for a job, good wages, and ready pay. Their good taste in giving our Magazine their hearty support is worthy of all commendation. We hope they will never have cause to regret their liberality towards us.

Keyport, as we have previously intimated, is *the* port, or entrance to the places named. From it and the surrounding neighborhood are sent to the New York market immense quantities of fine oysters, melons, and other luxuries "too numerous to enumerate." The crowded freights given to the two steamers daily plying between the place and New York city, cannot be otherwise than profitable to their owners. It was really "a sight" to see the long line of business wagons of all descriptions, which from early dawn until seven o'clock in the morning—the time of the first boat's sailing—were successively discharging their miscellaneous burdens upon the steamer's deck for transportation to the city. Horses, sheep, calves, oysters, melons, apples, potatoes, peaches, whortleberries, and—you can imagine the rest.

This, as we have said, is one of the watering-places in the vicinity of New York, but at the time of our visit (the 1st of Sept.) the frigidity of the season had frightened away nearly all *the summer birds*, which are annually accustomed to nestle in the place, principally from the families of the residents of New York and Brooklyn, the heads of which are too deeply immersed in business in those cities to allow of their rustication far from home. A few, however, still hovered about "the Pavilion," but their out-spread wings were indicative of an early departure.

## TRAVELING AGENT.

WE are happy to inform our friends in New Jersey, Pennsylvania, and the Western States, that Mr. RUFUS W. HOLTON is now on a tour through that part of the country as our authorized Agent, for the obtaining of subscriptions and advertisements to this Magazine. Any favors shown him will be considered a favor to us. He is furnished with the proper credentials, and is the only traveling agent from this office in the above-named States.

## FAMILIAR LETTERS FROM THE CRAFT.

NEW HAVEN, August 25th, 1859.

*Editor of the New York Coach-maker's Magazine:*

DEAR SIR—We understand that you purpose to publish an account of the carriage-makers' meeting, lately held in this city, in regard to Hibbard's patent shifting-rail, for carriage-tops.

The remarks made by Mr. Wier were quite widely understood at the meeting as in some way reflecting upon the character of our firm of "Munson & Sheldon," who are the attorneys for the assignees of the patentee. We regarded those remarks as a grievance, which he promptly redressed in the inclosed card, published in the New Haven papers. Now, as you purpose to scatter those remarks still more widely, you will see the propriety of publishing *with* them, his card. As you can have no motive to misrepresent or to injure us personally, you will probably have no objection to publishing the same, if you publish his remarks at all.

Yours truly,  
MUNSON & SHELDON.

MESSRS. EDITORS—I understand that some persons have supposed that in my remarks made at the late carriage-makers' meeting in this city, I reflected in some way upon the character of Messrs. Munson & Sheldon, attorneys in this city.

Now, I beg leave to say in as public a manner as possible, that I did not intend to make any remark or hint disparaging to them, whether as attorneys or otherwise, but expressly stated in that meeting, that in all my intercourse with them, they had treated me like gentlemen. All my remarks of a disparaging nature, were intended only to apply to persons who have made, as I believe, an unjust and improper use of patent rights. I sincerely regret that any one should have so misunderstood me as to apply those remarks to Messrs. Munson & Sheldon, for I had no occasion or desire to cast the shadow of a reproach upon them in any way whatever.

STEPHEN M. WIER.

NEW HAVEN, Aug. 19, 1859.

[This letter came too late for the September number, where the remarks referred to, were given. We give it here, although we did not understand Mr. Wier as personal in his remarks, in order that no one may have reason to charge us with unfairness.—ED.]

NEW HAVEN, CONN., Sept. 9, 1859.

E. M. STRATTON, ESQ.: *Dear Sir*—Having read in the September number of your widely-circulating and influential Magazine, the report of the meeting of New Haven carriage-makers, and some remarks in relation

to the adjustable top, patented by Harmon Hibbard in 1851, I wish to say in the main, your report is a correct and faithful representation of the doings of that meeting. You have not exaggerated its importance, or the spirit, energy, and earnestness of the discussion, or of the men who gathered there to protect themselves from what they believed to be an unjust interference with their rights as well as their business. In the heat of this excitement, it is not strange that some erroneous impressions should have been formed and made, and in my mind it is much more to be wondered at that in the desultory and altogether extempore discussion there had, more misconceptions of a graver character had not been set forth by the speakers, and set down by the reporters. I beg leave therefore to correct a few of these—which, so far as I am concerned, are and were real misconceptions—as I have not now, nor have ever had, the slightest inclination to injure or trespass upon any man's property, whether the same consists of patents, carriages, or real estate. There is nothing I suppose to be gained, either by misunderstanding or misrepresenting the claim of this patentee. I fear this has been done in one or two particulars. I do not know certainly what the patentee claims. I understand that it is claimed *that no shifting-rail whatever*, was ever made before this patent was granted. I have no doubt sufficient proof can be adduced to rebut such a claim, but the particular mode of arranging the rail under Hibbard's patent, is altogether a different matter. I confess that I do not quite understand how Hibbard's patent, in itself, can really be invalidated. I think the main point of this controversy is not the validity of Hibbard's patent, but it is, whether in a given case, or whether the carriage-makers generally, have in any way infringed upon that patent?

I have always thought that this patent was a good thing for what it was intended to cover, and from the very first I desired to buy that principle. We claimed that the model exhibited by Messrs. Munson & Sheldon was not a true representation of the original model, and did not fairly represent Hibbard's idea. My claim was that in the carriages we exhibited we had not infringed that patent, and that the carriage-makers generally, we thought, had not infringed; and in pursuance of that belief, I have investigated the matter with a good deal of care, and have spent therein some time and money. I have procured copies of all the papers relating to the issue of Hibbard's patent, and a facsimile, under the seal of the Patent Office, of the original model now in the Patent Office, and have collected some facts of considerable importance relating to it. Our neighbors of the craft, whom we thank very kindly, generously combined to assist us, and with the assistance thus extended to us, and the help of the best legal counsel, we considered every thing bearing upon the case, and we concluded that in some of the shifting-tops we could show there had been no infringement; in others of which we had ourselves manufactured many, the matter at the very best would be doubtful. We disliked the trouble and expense, as well as the uncertainty, of prolonged litigation, and from our knowledge of the attorneys retained in the case and the men interested in the patent, we concluded that it would be no boy's play to defend the suit brought against us, and that some one else might perhaps carry the matter forward better than we could, and we therefore made the best bargain we could for a settlement of the whole thing. The expenses of the investigation, as well as all the expenses for public meetings, hall rent, stationery, traveling expenses, and every

thing, was paid by me from the start. All labor done in the matter of the investigations was performed by me, and all the expenses paid by me, and the suits against us, as well as Messrs. Sizer & Doolittle (one of whom, Mr. Doolittle, is a relation of ours), have been withdrawn. For this step we have by some been blamed without stint or measure, and in conclusion let me say the way is open to any of the carriage-makers who hanker after the job of dancing attendance on courts, and paying the fees of patent lawyers to resist the claims of the patentees, and take their chances in a suit before our venerable Uncle Sam's Court. We confess to a preference for carriage-making over "lawing it," any day. We have bought Hibbard's patent for New Haven county, Conn., and can, we think, point out that the advancement of carriage-making must involve the use of the idea of Hibbard's Patent Adjustable Top.

I am respectfully yours, HOMER H. DIKEMAN.

[The following extract from a business letter, sent us by the Messrs. Hooper & Co., of London, will serve to show the opinion entertained of our Magazine in England, where our circulation is gradually extending.—Ed.]

CARRIAGE-MANUFACTORY, HAYMARKET, }  
London, (S. W.) Aug. 25, 1859. }

E. M. STRATTON, Esq.: Sir— \* \* \* \* We are regular subscribers to your Magazine, through Messrs. Trubner & Co., and feel much interested in its success. The information you give on trade matters is very valuable. The American climate, and the style of carriage adapted to it, are so different to our own, that your experience is in many cases both novel and useful to us. We are, sir,

Your obedient serv'ts,

HOOPER & Co.



THE SCENE OF A LATE DISASTER IN CROSSING THE ALLEGHANIES.—The ears of many of our readers have recently been stunned by the noise of that Equivocal (?) "beyond the Alleghanies," in which praise some jackass editors have shown their ignorance of the laws which regulate true mechanism. But the after-piece of the farce it has fallen to our lot to chronicle. This, although painful to our nature, nevertheless we find it our duty to undertake.

It appears that a "tall son of York" who had grown up and flourished "on this side of the Alleghanies," having become very uneasy in his circumscribed limits, undertook the rather hazardous task of crossing the mountains in a three-wheeled buggy, loaded with "extras" of horrid English, with the laudable end in view of putting down an imaginary conspiracy that was forming in the East by some who had "proved themselves traitors to me and my cause." To give success to the journey, our hero promised in setting out "to meet all our old friends 'on the level and (to) part with them on the square.'" The redemption of these promises, and the success of the undertaking, are beautifully illustrated in the above sad occurrence. Alas! poor Yorick! For the benefit of those undertaking a similar journey, we here add a quotation from Shakspeare for them to ponder over: "O thou invisible spirit of rum, if we had no other name by which to call thee, we would call thee Devil."



## INVENTIONS APPERTAINING TO COACH-MAKING AT HOME AND ABROAD.

## AMERICAN PATENTED INVENTIONS.

**JUNE 14. SLED BRAKE**—Albertus Larrove, of Cohocton, N. Y. I claim first, constructing the brake-eyes, R R, in the peculiar form shown and described, and for the purposes set forth.

*Second.* The combination of the brake-eyes, R R, with the brake Q, substantially as described.

**OMNIBUS REGISTER.**—H. C. Howells, of New York City, and J. C. Howells, of Madison, Wis. : We claim, first, The employment of a yielding platform to determine the value of the entry or fare and in combination with doors, or equivalent devices, to secure the registration of persons standing upon it, previous to their ingress or egress, substantially as specified and set forth.

*Second.* We also claim the employment and use of the circular or segmental doors, or equivalent devices, having within the area of their action a yielding platform, operating substantially as set forth and specified.

*Third.* We claim in combination with the yielding platform, G, an operative lever, N, and vertical rod, M, and puppet, Q, or their equivalents, substantially as set forth and for the purpose specified.

*Fourth.* We claim the pin or bolt, s, in combination with the arm, O, attached to the vertical rod, M, or their equivalents, for communicating motion the registering levers, S and T, by the action of the jointed arm, P, substantially as specified and set forth.

*Fifth.* We also claim the registering levers, S and T, operated as set forth, or their equivalents, and in combination with the registering ratchet-wheels, U and V, and the spring pawls, m m, together with the double dial, X, for registering the whole or half-entries or fares, substantially as set forth and specified.

*Sixth.* We also claim the stationary brushes, and the arrangement and combination of levers and rods, or their equivalents, for operating the doors and steps, substantially as set forth and described.

**HANGING CARRIAGE-BODIES.**—Leman C. Miner, of Hartford, Conn. : I claim, first, the application of the double-jointed shackle, H, to the front axle, whereby the vertical position of the spring and axle is sustained, and the fifth wheel and appendages dispensed with.

*Second.* The back axle braces with double joints, B B, to admit a free and easy vertical motion of the springs, and supporting the axle in its upright position, substantially in the manner as described.

**CLIP FOR CARRIAGE THILLS**—Daniel J. Riker, of Harlem, N. Y. : I claim extending the plate, c, of the carriage clip, in the form of a spring, to the eye of the shafts, and causing said spring to operate on the aforesaid eye, in the direction of the pull, to keep the parts of the bolt and eye in contact, for the purposes and as described.

**THE CONSTRUCTION OF SLED RUNNERS.**—John M. Spooner, of Springfield, Mass. : I claim making both of the runners and the bearers of a sled or sleigh, or other similar vehicle, of one continuous piece or rod of steel or other metal, substantially as set forth.

**THE RUNNING GEAR OF SLEDS.**—R. Sutton, of East Avon, N. Y. : I claim the arrangement and combination of the sliding collar, G, rods, o, reach, E, sliding bolster, F, pendants, i, links, j, and runners, B, as shown and described.

**WHIFFLETREE HOOKS.**—Lewis C. Terry, of Chenango, N. Y. : I claim a hook, pivoted or hinged to its supporting eye, which is cut away or flattened on its back, in the manner described, so that the point of the said hook, being in contact, or nearly so with its said holding eye, will securely confine a link, a ring, a staple, a trace or similar object, in all positions, excepting when turned back upon the said flattened or eccentric part of the eye, substantially as set forth in my description.

I also claim the right, in addition to the above, to so construct the hook and eye that the hook shall have but one motion, viz.,

a horizontal motion directly around the circle formed by the said eye, so that the said hook shall not drop or work from side to side; and the exclusive right to use the same in either or both the forms above mentioned and described, for all purposes for which they may or can be used, when constructed substantially as set forth.

**JUNE 21. AN IMPROVED ROLL FOR FORMING TIRES.**—J. H. Gage, of Nashua, N. H. : I claim the combination of the flange B, recess or depression O, wide shoulder or tread L, flange C, and short shoulder D, with a series of thin metallic disks F, said parts being constructed, arranged, and operating relatively to each other, substantially in manner, and for the purpose set forth.

**TRACE FASTENER**—Solon R. Atkins and D. H. Hull (assignors to D. H. Hull), of Plantsville, Conn. : We claim the metallic box, A, having a half-circular ring, B, on its end, and provided with a slide, C, which is to be operated by a knob, H, and held against the neck of the button on the whiffletree by springs D, as all arranged and operating in the manner and for the purposes set forth.

**JUNE 28. MACHINE FOR TURNING HUBS.**—Alexander Rickert, of Schoharie, N. Y. : I claim, first, the graduated scale, 1, in combination with the index, 2, and the sliding frame and hub blank and mandrel, operating in connection with the cutters, in the manner and for the purpose described.

*Second.* I claim the constructing the sliding sleeve with an opening at the angle, so as to slide over and upon the large cutter on the shaft, so as to cut any required size of hub without change of knife, as described.

**JULY 5. AN IMPROVEMENT IN HOOK FOR WHIFFLETREES.**—Shoeball Botterill, of Westmoreland, N. Y. : I claim the combination and arrangement of hooks, D D, and spring button E, in the manner and for the purposes set forth.

**AN IMPROVED MACHINE FOR FINISHING THE EXTERIOR OF RIMS OF CARRIAGE WHEELS.**—Reuben Kretz, of Montville, Ohio : I claim combining in the arm that gauges the plane, devices for varying the height of the radial arm, with the devices for varying its length, so as to enable the operator to dress a wheel straight or square across the edge, substantially as described.

I claim making the arm or bar, K, which guides the plane in the arc of a circle, to vibrate in the stock, so as to adjust and fasten it in the position desired.

**AN IMPROVED SPRING-SNAP FOR BRIDLE REINS.**—Marianus X. Yschus, of Bloomington, Ill. : I claim the combination of the two in one, in the manner described, and for the purpose described.

**JULY 12. AN IMPROVEMENT IN THE WHEELS OF BUGGY BOATS.**—Perry Davis, of Providence, R. I. : I claim arranging paddles upon the spokes of the wheels of a buggy boat, so that the wheels perform the twofold purpose of paddle-wheels and carriage-wheels, substantially in the manner and for the purposes set forth.

**AN IMPROVED DUMPING-WAGON.**—Anthony Iske, of Lancaster, Pa. : I claim the drop-door, D, with its lever, E, the partitioned box, a, with its rack-bar, c, on the bottom, the handled spindle, E K, for moving the same, as specified, when the several parts are combined as and for the purpose set forth.

**AN IMPROVED MACHINE FOR BORING HUBS.**—Daniel Quimby, of Littleton, N. H. : I claim the shaft, A, the boss, B, placed on said shaft, and provided with a conical bore, d, and having the collar, p, and arms, q, attached, the screw rod, C, connected with the collar, p, by the gearing, n o, and providing with the divided nut, D, attached to the upright, f, the whole being arranged to operate substantially as and for the purpose set forth.

I further claim, in combination with the parts above named, the convex projection, m, placed on the shaft, A, to operate as and for the purpose specified.

**AN IMPROVED SELF-DETACHING WHIFFLE-TREE.**—Wm. G. Russell, of Winchester, Va. : I claim a swingle or whiffle-tree, provided with a lever turn bar, e e e f f g g h h, as shown in Fig. 3, together with the spring clasp, o o, Figs. 1, 4, 5, and the hinged or jointed hooking ferrules, K K L L n n, when constructed and arranged substantially as set forth and described.

August 2. AN IMPROVEMENT IN CARRIAGE HUBS.—Jesse Pruette, of Aurora, Ill.: I claim the enlargement, C, upon box, B, having an annular flange, *a*, for the purposes specified, in combination with the nut, H, and its flange, *b*, when the same are both arranged substantially as and for the purposes set forth.

August 9. AN IMPROVEMENT IN DUMPING WAGONS.—William B. Twiford, of Chincoteague.—I claim the three-sided four-wheel, open frame, C, stationary crank axle, B, and long wagon body, D, when constructed and arranged for operating together, in the manner and for the purpose described.

Aug. 16. IMPROVED MACHINES FOR PUNCHING HOLES IN LEATHER.—G. L. Bailey, of Portland, Me.: I claim, *first*, the arrangement and combination of the bed-piece, L, lever, A, and hollow-cutter, C, provided with a standard, D, connecting rod, E, and treadle, H, as and for the purpose set forth and described.

*Second*. I claim the arrangement, as set forth, of the circular adjustable cutter bed, D, in such a relative position to the cutter, C, as to accomplish the object specified.

AN IMPROVEMENT IN THE RUNNING GEAR OF CARRIAGES.—Joseph Calef, of Buffalo, N. Y.: I claim the journal box, E, constructed substantially as described, and combined with the friction rollers, B, or slides, W, for the purposes set forth.

The combination of the axle, A, journal box, E, friction rollers, B, and equivalents, and hub, D, for the purposes set forth.

The arrangement of the jointed braces, L M N, in combination with the running gear of carriages, for the purposes set forth.

AN IMPROVEMENT IN SELF-RELEASING WHIFFLE-TREES.—Eugene Duchamp, of St. Martinsville, La.: I claim operating the two rods simultaneously, by means of the slotted guards, D D, in combination with boxes, G G, and lips, C C, in the manner and for the purposes specified.

AN IMPROVEMENT IN SELF-ACTING WAGON BRAKES.—B. S. Healy, of Cohocton, N. Y.: I claim the combination of a forked pole, arranged substantially as described, with the hounds, whereby the pole is free to slide in its forks, and operate the brakes without moving the forks backward in the hounds.

In combination with brakes pivoted to a fixed bar, as described, I claim the brake blocks, arranged and connected with the brakes as set forth, whereby the friction of the wheels on the blocks draws the brakes towards, and causes them to press with greater force against the wheels.

IMPROVED TUYERE.—Joseph P. Markham, of Pennfield, Mich.: I claim, *first*, the use of the intended valve, K, in combination with the outlet passages, H, constructed and arranged substantially as herein described, in such manner that, by moving said valve back and forth underneath the outlet, it will admit the wind to or shut it off from said outlet, equally and gradually, on each side of the central tube, I.

*Second*. I claim the mode of making the loose nozzle, J, independent of the masonry for support, by the use of the tube, I, and its socket, in combination with the ribs, G G G G, and corresponding rebates, substantially as set forth.

AN IMPROVED SAFETY REIN FOR BRIDLES.—Rudolph A. Nathurst and John L. Stewart, of Nashville, Tenn.: We claim the connection of the choke-strap with the common or ordinary driving reins, so as to act and serve for both purposes of driving and safety-rein, substantially as described, and this we claim whether it be temporarily or permanently affixed to the bridle or halter, whether a bit is used or not.

AN IMPROVEMENT IN CARRIAGE AND WAGON JACKS.—William N. Rowc, of Sharpsburgh, Md.: I claim the adjustable sliding catch plate, B, operating as described, in combination with the grease box, H, and jack, as set forth and described.

AN IMPROVEMENT IN HANGING THE BODIES OF WHEEL VEHICLES.—Chas. Bradfield (assignor to C. Stewart Bradfield), of Philadelphia, Pa.: I claim, *first*, attaching the wheels, C, to the body, A, by means of the arms, E, secured to the traverse bars, D, of the shafts or arbors, B B, which are fitted on the flanches,

A, and bearings, C C, of the plates, B, of the body, A, and have springs, D, placed between their flanches, A, and traverse bars, D, substantially as and for the purpose set forth.

*Second*. Attaching the thills, E, to the body, A, by means of the bars, G, fitted in the eyes, G, and secured thereon at the desired height by set screws, H, substantially as described.

AN IMPROVEMENT IN THE "FIFTH WHEEL" OF FIRE ENGINES AND OTHER VEHICLES.—Robert Poole (assignor to himself and G. H. Hunt), of Baltimore, Md.: I claim hanging the pivoted fifth wheel of a steam-fire engine, or other heavy carriage, to a bolster, when the latter plays within or over the axle of a vehicle, and is suspended to springs which have their bearings or seats on said axle, substantially in the manner and for the purposes described.

Aug. 23. AN IMPROVED HUB-REAMER.—Stacy A. Garrison, of Union, N. Y.: I claim the arrangement and combination of the cutters, C D, and the arbor, A, as and for the purpose shown and described.

Aug. 30. AN IMPROVEMENT IN CARRIAGE SPRINGS.—H. S. Clark, of Wyalusing, Pa.: I claim the arrangement and combination of the U-shaped leaves, B B, with the elliptical springs, A A, as shown and described, so that the extremities of the leaves, B B, will approach each other, and will be secured to the centres of the springs, A A, as specified.

#### RECENT EUROPEAN PATENTED INVENTIONS.

April 13. Richard Emery, 6 King street, St. James's Square, Westminster—certain improvements in carriages for common roads.

April 14. Ebenezer Partridge, Stourbridge, Worcestershire—an improvement in the manufacture of "pipe" boxes for cart and wagon axles.

April 18. James Boydell, Gloucester Crescent, Regent's Park—improvements in the apparatus applied to the wheels of locomotive traction and other carriages to facilitate the draught.

April 23. John Armstrong, Sunderland, Durham—improvements in drying and preserving timber.

April 23. John Argus, Glasgow, Lanarkshire—improvements in saddles.

April 26. Robert Main, Birkenhead, Cheshire—improvements in wheels for carriages.

May 11.—James B. Lyall, Castle Frome, Hertfordshire, and Frederick W. Campin, Strand, London: Improvements in the "saloon" omnibus, and other omnibuses, the wheels and springs whereof, and mode of attaching them, being applicable to other carriages.

May 14.—Matthew Leahy, 53 Hereford Board, Westbourne Park, London: Improvements in apparatus for facilitating the draught of carriages.

May 18.—John Brennand, Manchester: Certain improvements in the construction of carriages, for the conveyance of passengers, goods, and minerals, and also in the apparatus for propelling the same.

May 23.—Harry Arthur Cooke, Chancery Lane, London: Improvements in omnibuses.

Richard A. Broonan, 166 Fleet street, Westminster, London: Improvements in axles and fitting wheels thereto.

May 24.—James Craig Fisher, 51 Cathedral Street, Glasgow: Improvements in preparing paints and varnishes.

May 30.—Marcus Davis, 5 Lyon's Inn, Strand, Westminster, London: Improvements in the construction of wheels, axles, and boxes for carriages.

June 18.—James Ransley, 19 Princess Terrace, Islington, London: An improved omnibus.

July 5.—John Watkins, and James Pugh, Aberdare, Glamorganshire: Improvements in lubricating wheels.



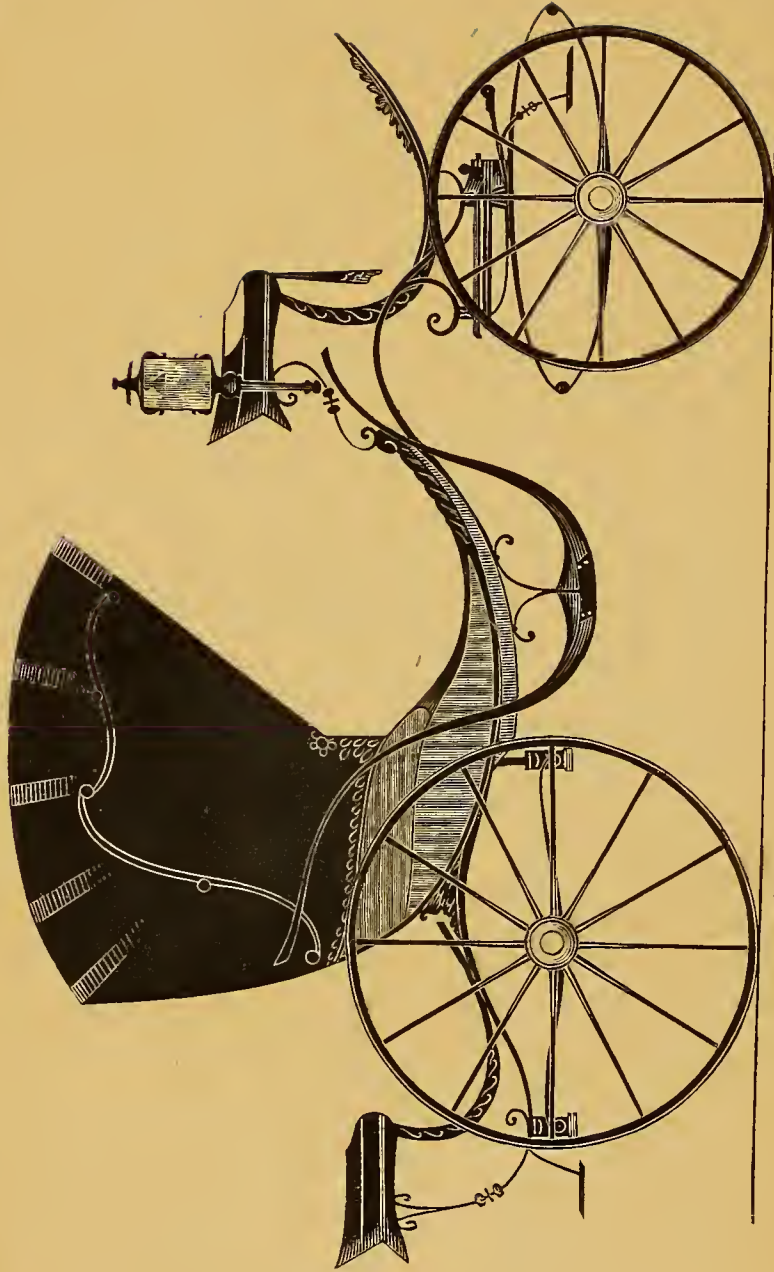

TRIPLE PHAETON.— $\frac{1}{2}$  IN. SCALE.

*Engraved expressly for the New York Coach-Maker's Magazine.—Explained on page 110.*

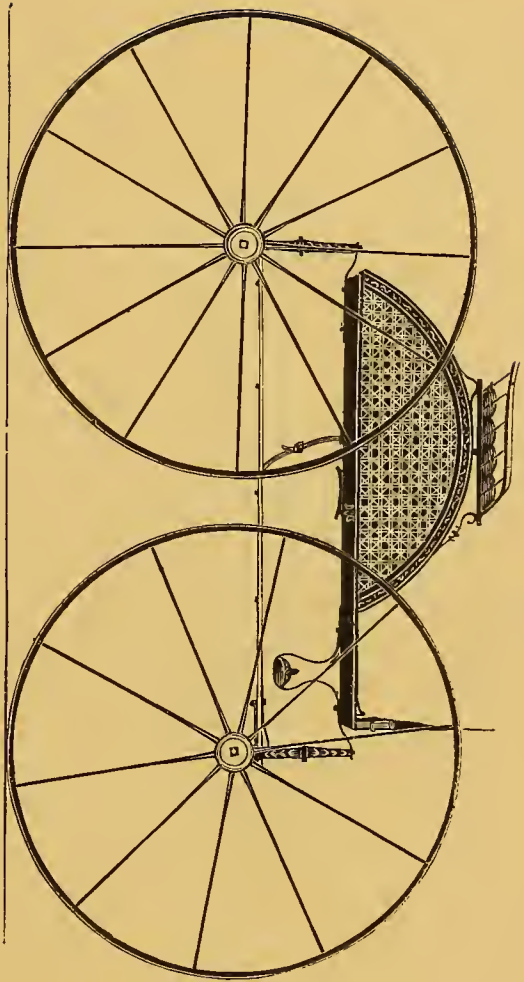

FANCY BUGGY.— $\frac{1}{2}$  IN. SCALE.

*Engraved expressly for the New York Coach-Maker's Magazine.—Explained on page 110.*





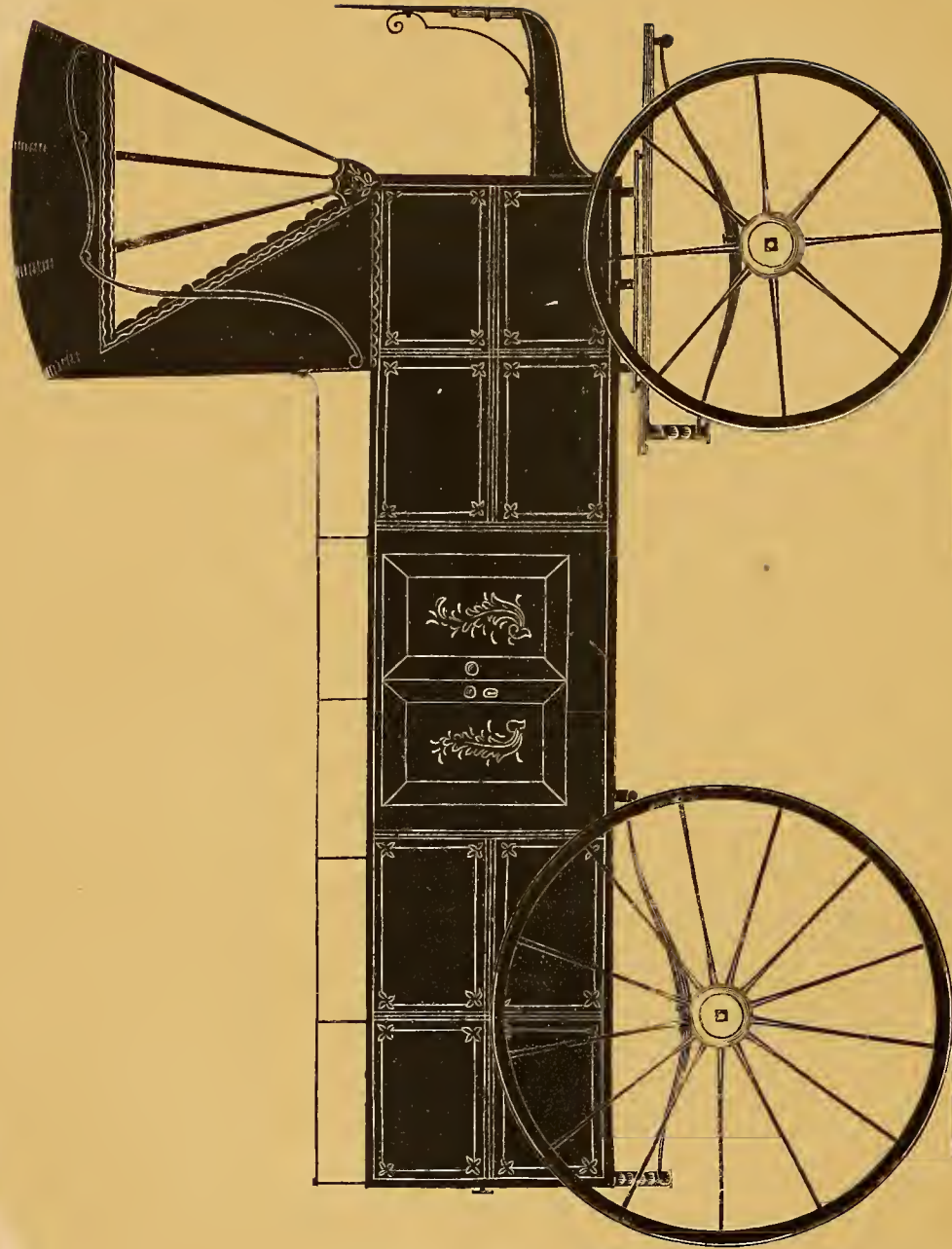

PEDDLER'S WAGON.— $\frac{1}{2}$  IN. SCALE.  
*Engraved expressly for the New York Coach-Maker's Magazine.—Explained on page 110.*



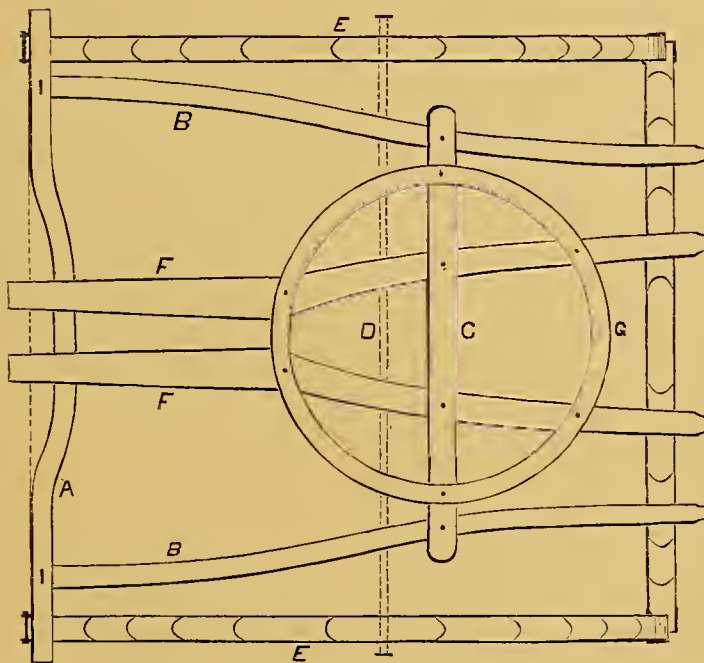
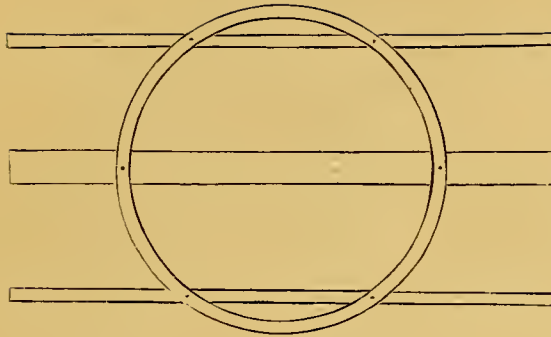

SECTIONAL CARRIAGE-PART FOR THE  
PEDDLER'S WAGON, ON PLATE 20.

$\frac{1}{2}$  IN. SCALE.

*Engraved expressly for the New York Coach-Maker's Magazine.  
Explained on page 110.*





DEVOTED TO THE LITERARY, SOCIAL, AND MECHANICAL INTERESTS OF THE CRAFT.

Vol. II.

NEW YORK, NOVEMBER, 1859.

No. 6.

## Miscellaneous Literature.

For the New York Coach-maker's Magazine.

### THE AUTOBIOGRAPHY OF CALEB SNUG, OF SNUGTOWN, CARRIAGE-MAKER.

#### CHAPTER IV.

The pork-eater at Flatt's Hall—Symptoms of rebellion among "the boys"—The mysterious writing on the wall, and an unsuccessful inquiry as to its origin—Mrs. Flatt becomes very indignant—A dietetic revolution at Flatt's Hall—Model indenture—Reflections upon some of its injunctions.

ABOUT the time mentioned in the last chapter, the firm had taken another apprentice "under instructions." He had been accustomed to better fare in other quarters, and beside had sufficient courage to claim his rights in any circumstances. This young man's name was James Bowen, who declared that he could live on boiled salt pork, and that he had no fears of starving as long as he was plentifully supplied with that article. We soon had the strongest evidence that his was no empty boast. At his taking dinner for the second time at Flatt's Hall, he tarried long after all the others had deserted the table, and the way in which the unwholesome flesh disappeared, *must* have been very alarming to Mrs. Flatt, with her notions of economy, and a presumptive evidence in her mind that her pork-barrel would very soon become exhausted. What the result would have been, it required no prophetic mind to foresee, had not a simple circumstance produced a species of revolution. One day, after dinner, we held a consultation in view of our grievances, as to what should be done under the circumstances. Trotter declared that he "could not endure such living" and that he, for his part, would stand it no longer." Mortimer said he had so long eaten hogs' flesh, that he was ashamed to look that "respectable" animal in the face, and all unanimously agreed that

"Our wearied limbs, o'ertasked with work,  
Could ne'er endure this pork, pork, pork!"

That afternoon was spent in devising some means of making our dissatisfaction known at head-quarters, but no one seemed to possess sufficient courage to broach the subject to the "old woman." It was evident that whoever

might do it, would find "a nest of hornets about his head." A lucky thought however seized one individual, and in a spirit of determination "to do the next best thing," there soon appeared in white chalk upon the walls of the shop in several places, the ominous word "PORK," and along the stove-pipe, "Too much pork for a shilling," and other mysterious allusions, not very plainly understood by persons uninitiated. These inscriptions had for several days *ornamented* the interior of the work-shop, unobserved by the boss, and we began to think our labor had been in vain. Fortunately, however, "the thing" was not fated to rest there. One day Mrs. Flatt had occasion to visit the shop on some special business, and her eagle-eyes having been accidentally directed to the chirographical work of one of us, that graced the side of the stairs, up which she was about to ascend to the second story, she in a tone of anger inquired of a person near by, "if we kept pork for sale there." The question, which under some circumstances would have elicited a reply, in this case was treated with silent contempt, until our purveyor had gained the upper part of the shop, when a chorus, loud and repeated *a la* hog, gave her to understand that her inquiries had at least elicited a grunt or two. Feeling that her presence was not exactly welcome, she was glad to get away from those among whom she supposed herself insulted. This demonstration gave her to understand that she had not exercised oppression with impunity. This was about 11 o'clock in the forenoon. Twelve o'clock arrived, and all were called to dinner, except Colin, who having on that day been intrusted with the oversight of varnish-making, was obliged to tarry behind until relief came from some one of the dining-party. We had our regular dinner of pork and potatoes, but no butter, owing to the *defective* memory of Mrs. Flatt; so *that* luxury was "nowhere" until the last boy had left the table. At this meal, singularly enough, Mr. Flatt did not make his appearance, as some business had necessarily called him away. After dinner it fell to my province to look after the varnish-kettle in Colin's absence to dinner. In the meanwhile, Mr. Flatt had returned home. While in the house, Colin surmised, after overhearing the following conversation, that trouble was brewing:

Mrs. Flatt (to her husband on his entering the door).—  
"I was in the shop this forenoon, and saw that the walls

were defaced with sentences in chalk, such as 'Pork,' &c. I also heard grunting in imitation of a hog, which I know was meant as an insult to me. I want you to take this matter in hand, and punish the guilty, *won't you?*"

*Mr. Flatt.*—"Well, the boys ought to have something for a change in their diet." (This answer was singular, coming as it did, from Mr. Flatt.)

*Mrs. Flatt* (in response).—"They shall have nothing else but pork, every day, for a fortnight at least. That will be too good for such a set of hogs! yes, it will."

*Mr. Flatt.*—"I think that boys who work hard should have a little fresh meat once in a while. *We* must indulge them occasionally."

*Mrs. Flatt.*—"Indulge them! No, indeed; I'll pay them off for their insults to me. *You* will overhaul them if you have any love left for me, and punish them for their hoggish conduct; the villains!"

*Mr. Flatt* (highly incensed).—"I'll see to them, Betsy."

Colin, in anticipation of the turn matters were taking, hurried through with his dinner, and hastily returned to the shop, advising the whole shop's crew of what might be expected. No time was to be lost, and we speedily agreed to secrecy—were very soon an organized body of Know-nothings. Very soon Mr. Flatt appeared, ascending the hill on which the shop stood, hat in hand, and scratching his head, a sure prognostic that a storm was approaching. Entering the shop-door, he thundered out (pointing to the offensive word), "Who wrote that word there, boys?" No lip responded to this inquiry; his voice alone was heard, "If I *can* find out who did that, I will jam him against 'them stairs' until he rubs out that word, except Caleb done it; he is Towner's apprentice, I have nothing to do with him." I have often wondered at this reservation on the part of Mr. Flatt, but I have always supposed that by making an exception in my hearing, he hoped thereby to get out of me the facts in the case.

*Mr. Flatt* (still excited).—"Do you know, Mortimer, who wrote that word 'Pork,' on these stairs?"

"No sir!"

*Mr. Flatt.*—"Do you, Dimon?"

"No sir!"

*Mr. Flatt.*—"Nor you, Colin?"

"No sir!"

*Mr. Flatt.*—"Nor you, William?"

"No sir!"

Thus he went through all the work-shops, and it is needless for me to say, with no better success. In despair, at length as a last resort, Caleb was questioned as to his knowledge in this affair, but he was as ignorant as his shop mates—nobody knew any thing of the mysterious writing, nor how it came there!

My readers will very naturally ask, "If these things were unknown to Mr. Towner?" Of course he was as much in the dark as any of us—*just about*. He was "one of us," and many a time did he furnish us with crackers and cheese at his own expense, from the grocery in the village; otherwise we could not have had strength sufficient to have endured the labor imposed upon us.

This matter was now assuming a rather serious complexion for the oppressive party. The whole story was soon whispered about the village—and stories generally never lose any of their details in a country village—so that Mr. Flatt, who was very fond of "dropping in" to the grocery, and other stores therein, soon found his ears saluted with such interrogations as, "Well, Flatt, what

about that pork?" "Any pork left to sell?" with other equally pertinent questions. Just about this time in our story, the musical blacksmith got on "a fuddle," and took this opportunity to tell Mr. Flatt "plump in his face," that he was a mean man, that he was starving his boys, and that they were only saved from such a catastrophe by the generous self-sacrifice of Mr. Towner, in buying crackers and cheese for their nourishment.

But in this case, as in a great many others before and since, public opinion and public sympathy with the oppressed, had its salutary influence even upon Mrs. Flatt's vindictive mind. A complete change soon was seen in the kind and preparation of the food set before us, and this improvement ended in the transfer of the table and its management to the care of the son-in-law and his wife. After this we found very little cause for complaint, consequently matters settled down into the usual monotony of a mechanical life.



AMERICAN SCENERY—SNUGTOWN IN THE DISTANCE.

For the purpose of preserving a connection in the above story, I have anticipated one important event in this history. I will give it here. The hard treatment I had received at Mr. Flatt's hands had prejudiced me against him, generally, and had had the effect to cause me to leave his employment altogether, and return home, previous to this last adventure, when the persuasions of Mr. Towner, and his proposal to take the sole charge of my instruction to himself, induced me to go back to Sawgetup, and complete my apprenticeship. To this end, and to secure faithfulness in both parties, the following indentures were drawn up and duly signed by the two contracting parties of both sides. The *sui generis* complexion of this document of an early age, in New England, must very forcibly arrest the attention of the intelligent reader at the present time.

"THIS INDENTURE, made between James Towner, of the town of Sawgetup, in the county of Catchum, and State of Connecticut, on the one part, and Washington Snug, of the town of Snugtown, in the same county and State, on the other part, this 16th day of October, 1816, witnesseth:

"That the said Washington hath placed and bound his minor son, Caleb Snug, aged eighteen years, the 11th day of May, 1817, an apprentice to said Towner, to be instructed in the art, mystery, trade, and occupation of making wagons and carriages, if the said Towner work at carriages, during the term of said apprenticeship, sufficient to learn

said apprentice said art; and said Caleb is to live with said Towner, and serve him, from the date thereof, until he arrive at the age of twenty-one years, all which time the said Caleb, as an apprentice, shall faithfully serve, and be just and true unto him, the said Towner, as his master, and his secrets keep, and his lawful commands everywhere willingly obey; he shall do no injury to his said master, in his person, family, property, or otherwise, nor suffer it to be done by others; he shall not embezzle or waste the goods of his said master, nor lend them without his consent; he shall not play at cards, or any other unlawful game, nor frequent taverns, or tippling-houses, or shops, except about his master's business, there to be done; he shall not contract marriage, nor commit fornication, nor at any time absent from his master's business himself without his consent; but in all things behave himself as a faithful apprentice.

"And the said Towner, for the consideration of the premises, doth covenant and agree to and with the said father and son, each by himself, respectively and jointly, to teach and instruct the said Caleb, as his apprentice, or cause him to be taught in the art aforesaid, after the best way and manner that he can; and to instruct him in religion and morals, and cause him, as far as he can, constantly to attend public worship on the Lord's day; and the said master will provide for and allow to his said apprentice, meat, drink, washing, and lodging, and shall pay the sum of twenty-five dollars per year towards clothing for said apprentice during his apprenticeship, and furnish all necessaries, except clothes, in sickness and in health, proper and convenient for such an apprentice, during the time of his apprenticeship, unless said apprentice becomes permanently unable to learn or work at said trade by some sickness or misfortune, when, and in such case, he shall depart, and at the expiration of said term, said Towner shall dismiss said Caleb from his service.

"Made and executed in Sawgetup, State of Connecticut, this 16th day of October, 1816.

"WASHINGTON SNUG, [L.S.]

CALEB SNUG, [L.S.]

JAMES TOWNER, [L.S.]

"Signed in presence of { JOHN JACKSON,  
DAVID DOLITTLE."

My readers will observe the *blueness* of the above document. It would not disgrace the production which passes to-day under the name of "The Blue-Laws of Connecticut," and is a good reason in excuse why I should faithfully keep the secret as to who had so industriously offended the *ci devant* mistress at Flatt's Hall, by that "handwriting on

the wall"! But the injunction to "instruct him in religion and morals" was perfectly ridiculous, as my boss was just about as well versed in those accomplishments as the natives of Senegambia are supposed to be.

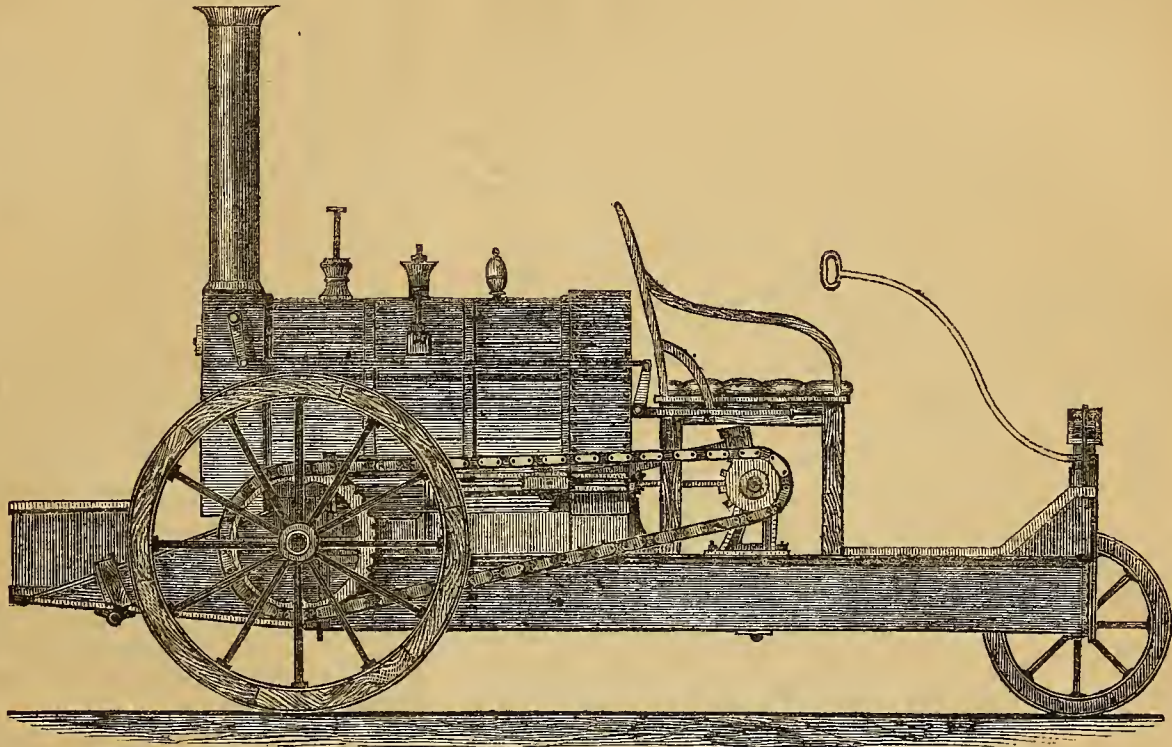

LOCOMOTIVE STEAM CARRIAGE FOR COMMON ROADS.

THE common road steam-carriage which we here engrave was designed for the Marquis of Stafford and Mr. J. E. M'Connell, of the London and North-Western Railway, and was built by Mr. Thomas Rickett, at the Castle Foundry, Buckingham. It was intended to carry three passengers at ten miles an hour, and we believe that it has amply fulfilled these conditions. It is carried upon three ground wheels—two drivers behind, and a single running steering wheel in front. The main framing of the engine is formed out of a pair of longitudinal parallel sheet-iron tanks. Between these at the back is a coal store, whilst at the front is the leading wheel, room being left between the tanks for this wheel to turn to a right angle. The boiler is fixed at the back, above the coal store; and the actuating steam-cylinders are set horizontally, one on each side of it, an ample seat for three being provided in front between the forward end of the boiler and the steering-wheel. The first motion crank shaft is beneath the seat, the piston rods being coupled on in the usual manner. This shaft carries a pin or pitch wheel, over which is passed an endless pitch chain, which also passes over a larger chain wheel upon the driving axle. The respective diameters of the driving and driven chain pulleys is as 1 to 2½. The driving-axle carrying the large ground-wheels is at the back end of the tanks, which carry guides for the axle-boxes, a single steel spring being extended across to rest on each axle-box. Beyond this axle is a foot-board, with a seat answering as the stoker's tool-box. One driving-wheel is fast upon the driving-axle, and the other is geared with it through the intervention of a clutch. This clutch, however, is never disengaged, except when the engine is to be turned shortround on a single wheel as a centre.

The engine is steered with ease by a lever handle, connected with the fork of the front wheel by a feather, which admits of the vertical play of the spring. The steering handle is disposed central, or in line with the right-hand seat, at the side of which is the steam-regulator handle. In this way the person occupying this seat acts as driver, as he has complete control over the engine. The steam cylinders are three inches in diameter and nine inches stroke; the working steam pressure is 110 pounds; the driving-wheels are three feet in diameter. The boiler has an internal flue and return tubes, and is not materially affected by variations of level. It is of cast steel, and is nineteen inches in diameter, and affords an area of thirty-one square feet of heating surface. The water tanks, which are of very ingenious structure, as both carrying water and acting as framing beams, carry forty-two gallons of water, sufficient for an eight or ten miles' run. The coal store has capacity for from twenty to thirty miles consumption. The weight of the engine itself is nineteen hundredweight and a half; with its load of passengers and stoker, and water and coal, it weighs thirty hundredweight. Its fuel consumption is from six to seven pounds of coal per mile, and the boiler evaporates about a gallon of water per minute.

On good level roads it runs easily at twelve and fourteen miles an hour; and it can ascend hills of 1 in 12—pretty steep work. Its performance in this respect is best measured by remembering that nearly five horses' power is necessary to take thirty hundredweight up an incline of 1 in 12 at four miles an hour. Its motion is extremely easy in running, as it is well mounted on springs; the only noise of importance made by it being that of the blast pipe. It seldom produces smoke, but, as the passengers are in front of the chimney, neither steam nor smoke can create any discomfort for them. The promoters of this new attempt at making steam assume more directly the functions of horses, are very sanguine of success, and expect the plan, or something like it, to come into very general use. This, of course, remains, as the builder himself says, to be seen. The working conditions are very different to those attending railway engines. Great power and light weight are leading essentials. They must be obtained in combination, or even partial success can never be reached.

It was for the sake of going as far as possible in the direction of lightness that Mr. Rickett adopted so small a boiler, as he deemed it better to burn an extra half-pound of coal per mile than to carry a hundredweight more metal and water. The available tractive power of the engine, which has had a lengthened trial upon the roads in Buckinghamshire and the neighborhood, is equal to 380 pounds, or one sixth of its weight, or one ninth of its gross load. But as the opposing gravity when on an incline of 1 in 12 is equal to 280 pounds, it is clear that the roads must be in good order to insure that the friction will not exceed the other hundred pounds in  $1\frac{1}{2}$  tons.

The chief practical difficulty met with in running on the ordinary roads is the passing horses, and this will always be a difficulty, for it is hardly to be expected that the horse will ever learn to pass automatic machinery without fear and trembling. At present, at any rate, frequent stoppages are necessary to allow the animals to pass. It seems that there is a feeling abroad that common road steam traction will shortly be an established fact, for a bill under the superintendence of Mr. Garnett, Mr. Wilson Patten, and Mr.

Ridley, and which has passed to a second reading, enacts the following scale of tolls to be levied by corporations, commissioners, trustees, and other persons, viz.: For every locomotive attached to any loaded wagon or carriage, 1s.; for every wagon, wain, or carriage, drawn by such locomotive, and having the felloes of the wheels not less than six inches nor more than eight inches in breadth, the sum of 3d. for each pair of wheels; for every wagon, wain, or carriage, drawn by such locomotive, and having the felloes of the wheels not less than eight inches in breadth, the sum of 4d. for each pair of wheels. Every locomotive must consume its own smoke. The reason for the bill is recited in the preamble, to wit, that the use of locomotives is likely to become common on turnpike roads for drawing wagons and carriages; and the existing Turnpike Acts do not provide for the contingency.—*Practical Mech. Journal.*

### COACH-MAKING, HISTORICALLY CONSIDERED AND INCIDENTALLY ILLUSTRATED.

BY THE EDITOR.

#### CHAPTER XVII.

The stage-coaches of 1755 humorously described—The first built in England mounted on two wheels—A Frenchman's picture of English traveling ten years afterwards—Post-coaches, by reason of peculiarly constructed roads, liable to be overturned—Remedies suggested—Honor and contempt attending inside and outside passengers stated—"Old Inside's" complaints against the general use of coaches.

FROM the "Tales of an Antiquary" we take the following description of stage-coaches in 1755: "In my own young days, stage-coaches were constructed principally of a dull black leather, thickly studded by way of ornament with black, broad-headed nails, tracing out the panels, in the upper tier of which were four oval windows, with heavy, red wooden frames, or leather curtains. Upon the doors, also, were displayed, in large characters, the names of the places where the coach started, and whither it went, stated in quaint and antique language. The vehicles themselves varied in shape. Sometimes they were like a distiller's vat, somewhat flattened, and hung equally balanced between the immense front and back springs. In other instances, they resembled a violoncello-case, which was, past all comparison, the most fashionable form; and then they hung in a more genteel posture, namely, inclining on the back springs, and giving to those who sat within, the appearance of a stiff Guy Fawkes uneasily seated. The roofs of the coaches, in most cases, rose in a swelling curve, which was sometimes surrounded by a high iron guard. The coachman, and the guard, who always held his carbine ready cocked upon his knee, then sat together, not as at present, upon a close, compact, varnished seat, but over a very long and narrow boot, which passed under a large spreading hammer-cloth, hanging down on all sides, and finished with a flowing and most luxuriant fringe. Behind the coach was an immense basket, stretching far and wide beyond the body, to which it was attached by long iron bars or supports, passing beneath it, though even these seemed scarcely equal to the enormous weights with which they were frequently loaded. These baskets were, however, never great favorites, although their difference of price caused them to be frequently well filled."

The wheels of these old carriages were large, massive, ill-formed, and usually of a red color, and the three horses that were affixed to the whole machine—the foremost of

which was helped onward by carrying a huge, long-legged elf of a postillion, dressed in a cocked hat, with a large green and gold riding-coat—were all so far parted from it by the great length of their traces, that it was with no little difficulty that the poor animals dragged their unwieldy burden along the road. It groaned and creaked at every fresh tug which they gave it, as a ship rocking or beating up through a heavy sea, strains all her timbers with a low, moaning sound, as she drives over the contending waves.

The first post-chaise built in England, is said to have been constructed in Queen street, Lincoln's Inn, in a building where the same business is, or was until recently, carried on. It had but two wheels, and was open in front. One writer describes it as having very much the appearance of a bathing-tub.

It was some time before stage-coach traveling was performed at night, the practice of which probably suggested the necessity of a guard, because of danger from robbers. Fielding, in his "Joseph Andrews," represents his hero as having been robbed and left for dead by foot-pads, in the night, and afterwards, "just as he began to recover his senses, a stage-coach came by. The postillion, hearing a man's groans, stopped his horses, and told the coachman."

M. Grosley, a French traveler who visited England in 1765, entertains us with the following account of his journey from Dover to London, which serves to illustrate our subject at the period: "The great multitude of passengers with which Dover was crowded, afforded a reason for dispensing with a law of the police, by which public carriages in England are forbidden to travel on a Sunday. I myself set out on Sunday, with seven more passengers, in two carriages called 'flying machines.' These vehicles, which were drawn by six horses, go twenty-eight leagues in a day, from Dover to London, for a single guinea. Servants are entitled to a place for half that money, either behind the coach, or upon the coach-box, which has three places. The coachmen, who were changed every time with our horses, were lusty, well-made men, dressed in good cloth. When they set off, or were for animating their horses, I heard a sort of periodical noise, resembling that of a stick striking against the nave of the fore-wheel. I have since discovered that it is customary with the English coachmen to give their horses the signal for setting off by making this noise, and by beating their stools with their feet in cadence; they likewise use the same signal to make them mend their pace. The coach-whip, which is nothing else but a long piece of whalebone, covered with hair, and with a small cord at the end of it, is no more in their hands than the fan is in winter in the hands of a lady; it only serves them to make a show, as their horses scarce ever feel it."

The "flying-coach" alluded to above as a "flying-machine," is said in the Diary of Anthony Wood, to have completed the journey between Oxford and London in thirteen hours, which is certain evidence that the improved roads and improved vehicles were all contributing to render traveling more expeditious and pleasant. Still there were those whose prejudices or interests concocted serious charges against their use. One was that they were very liable to overturn, and endanger the life of the passenger. In the "Gentleman's Magazine" for 1771, we find a correspondent stating the cause of these accidents and suggesting remedies. He says that the bodies are suspended too high from the ground, and too heavily laden with passengers on the roof. He wishes that carrying passengers on the top could be strictly forbidden, but is appre-

hensive that though it were, the ambition of coach-owners would raise the inside fares so high, that it would prevent many from riding in coaches. Another cause is ascribed to the excessive roundness of "turnpike-roads," which was frequently so great that one coach could not pass another without great danger of upsetting. This "reformer" suggests as one remedy, that it should be made imperative on coach-proprietors to have their axletrees made longer, so as to track five feet eight inches, instead of four feet eight. This improvement would not only render the coach less liable to overturn, but allow of the body being made larger, so as to contain six passengers. This would lessen the price of an inside seat, and traveling in consequence become cheaper.

What effect our speculator—for he evidently was not a coach-maker—may have had, may be inferred from the following information derived from the "Annual Register" for 1775. We are told that "the stage-coaches of the day generally drive with eight inside and often ten outside passengers each." It is there stated that there were upwards of four hundred of the coaches included in the terms flies, machines, and diligences; "and of other four-wheeled carriages, seventeen thousand."

A later writer in the same Magazine (The Gentleman's) seems to have entertained quite different opinions from the previous one, for he complains of the alterations which had been made. He says that "of late years, a great revolution had taken place in journeyings by stage-coaches, and which had produced nearly the whole of those accidents which were attributed to the coachmen. This was the fashion of preferring the outside to the inside of coaches. If this fashion continued, he had no doubt, that posterity would inquire what the inside of a coach was made for. It had already come to be considered as a receptacle specially appropriated to the effeminate, the sick, or the aged. This demand for outside places had produced two results; one was a rise in the price of outside seats, and another, increased accommodations before and behind and at top, for the increased number of persons who chose to travel in that way. People seemed to be quite unconscious that there was any more danger by riding with eighteen outsiders, than in walking with an equal number of persons on a grass-plot, though nothing could be clearer than that a vehicle thus overloaded at top and comparatively empty within, was in great danger of being overturned. Stage-coach passengers had learnt this preference from people of fashion, who exhibited a decided preference for riding on the outside of their private carriages. This had necessarily altered the relative estimation in which inside and outside passengers were held, and had abolished the order of precedence formerly observed at country inns. There, in former times, while the *insides* were shown into a handsome dining-parlor, the *outsides* were referred to the kitchen, or had their meal in some inferior apartment, and were considered as only a small degree above 'wagon-passengers.' But now, were an inn-keeper to judge thus of stage-coach outsiders, what dreadful blunders would he not make—what insults would he not offer?"

He continues: "The time was, sir, when from my country-house, at the bottom of Gray's Inn lane, I could, on a Sunday morning, from five o'clock or sooner, see hundreds beginning their journey on foot to places eight or ten miles distant; but now, the same class of people, and of the same age, are mounted aloft with a dozen and a half of lazy souls like themselves, and confine their walks to their friends'

gardens—thirty feet by twenty, including a pond. Nay, what shocks me more, when I reflect on past times, is, to see even the Islington stages at three or four o'clock in the afternoon, loaded inside and outside with hale, hearty, stout young brokers, excise and bank clerks, and other gentlemen, who can learn only from their fathers for what purpose legs were given them." Thus, "Old Insides" berates those who act contrary to his tastes, and has found imitators even in the present day.

#### CARRIAGE-BUILDING CONSIDERED AS AN ART.

THE art of coach-building holds a somewhat anomalous position in the world of industry. Essentially, and of necessity for its practical purposes, a *mechanical* art, it nevertheless includes so much of what is termed "art" *par excellence*, that it may justly claim to be considered more than a mere industrial manufacture, producing only things of mere utility, and to rank along with the goldsmith's work, and the higher efforts of the potter, as an "art manufacture." A few remarks may serve to justify this claim to the non-professional reader, and not be without use to the instructed manufacturer.

To produce a well-shaped "body," which is the principal part of a carriage—that part, indeed, to which all the other parts are but accessories—requires no small amount of artistic taste, proficiency in drawing, and knowledge of perspective. There must be, firstly, a good outline, composed of easy flowing curves, so adjusted as to harmonize with each other, while they follow the general directions which the uses of the thing necessitate; and, secondly, there must be a symmetrical rounding of the surfaces of the body: a mere outline on the flat would neither satisfy the eye, nor give sufficient room in the vehicle without making it unnecessarily large and heavy.

In order to combine the outline with the rounding, the carriage-designer is obliged to lay down his lines of construction with due consideration as to the position of each part in the finished body—to employ, in fact, the rules of perspective, and allow for the effects of fore-shortening and distance, so that the curves drawn upon a flat surface in the outline drawing may be reproduced without distortion upon the rounded surfaces of the body. For want of due attention to this, it frequently happens that two manufacturers, working from the same design, produce carriages which, when finished, have scarcely a single point of resemblance.

Many carriage-bodies are shaped as if they were portions of a gracefully moulded vase or tazza, and may compare, not unequally, with the best forms thrown from the potters' wheel, while the coach-maker has this difficulty which the ceramic artist has not, that his "vase" is made up of many parts, each of which must be formed separately before it takes its place in the skeleton of framework, which, when covered with paneling, constitutes the body of a carriage. He has also this further difficulty, that, in laying down his lines, he must foresee the ultimate form of the body: if his lines are faulty, the body will be faulty, for he cannot correct his lines as the construction goes on. He can only observe from time to time, and correct in his future productions the faults which he observes in the results of his earlier attempts. In this he is frequently baffled by the rapid changes of fashion: and unless he can discover and learn to apply the principles of those fundamental forms which underlie all things of

plastic design, his constructions will always be faulty and displeasing to the instructed eye.

It may be remarked, *en passant*, that the curved surfaces of carriage-bodies should be treated as parts of those solid natural objects which the eye of man universally admits to be symmetrical and pleasing; as, for instance, the egg, the fir-cone, and various spheroidal bodies. Various as are the shapes of modern pleasure-carriages, a little observation will serve to show that their outlines are referable to two broadly defined styles of drawing—one of which is easy, flowing and natural; the other, stiff, quaint, and conventional. The outlines of the former style are derived chiefly from the circle and the ellipse, of the latter from the hyperbola and the parabola. In both styles good effect is produced by contrasting the curved lines with straight lines, horizontal, perpendicular, and oblique.

But the body is not the only part of the carriage which requires the exercise of artistic skill in its design and arrangement. The under-carriage and its ironwork and the various appendages should be so designed as to harmonize with the style of the body, and constitute with it a work which may be judged by the laws of plastic art, and present to the eye from every point of view none but pleasing and harmonious outlines, and gracefully swelling or hollow surfaces.

In bringing about this result, the coach-smith is an important auxiliary. It is not absolutely necessary that he should be a "Quentin Matsys," but he must possess something of his spirit, and have the eye of an artist, to guide his plastic hammer in moulding the heated iron, and his "wrench" in twisting it into graceful curves. The draughtsman may give him outlines for some parts of his work, but no drawing on a plane surface can dispense with the necessity of a good eye for form in the practical smith.

From what has been said it may readily be inferred that we regard the design and arrangement of a carriage, apart from its decoration, as an art very nearly akin to the ceramic or plastic art. Taken in conjunction with the use of colors and metals, in its decoration, its claim to be considered an "art-manufacture" is greatly strengthened.

Regarding the art of carriage-building from another point of view, it may claim kindred with the master-art of this age—that of the engineer. A carriage, considered as to the work it has to do, is a machine which is subjected to more highly destructive agencies than any other. Used upon roads of all degrees of roughness, at varying speeds, and with loads limited only by the power of the horses to draw, it is, at the same time, exposed to all the vicissitudes of weather, and the ruinous effects of dirt and dust, while it is expected to be equally easy to the passengers under all circumstances, and to endure all these destructive agencies for indefinite periods without the care, or even the occasional examination of a properly qualified mechanic. A very eminent engineer used to say, that considering the way in which all these difficulties are overcome in a well-constructed modern carriage, it may fairly claim to be termed one of the most perfect machines in existence.

In carriage-building, three things are sought to be combined—lightness, strength, and elegance. To combine the two former without detriment to the latter, is the engineering problem proposed to the coach-builder. His materials are woods of different kinds, and iron. In no branch of the mechanical arts, probably, has the value of wood and iron, in combination, been so thoroughly appreciated, as in this;



certainly, in none has the combination been so severely tested.

Long before engineers and builders discovered the value of this combination, the coach-maker had employed it in his under-carriages; and more recently in his "bodies," the use of iron edge-plates has relieved him from the constructive difficulties arising from the claims of fashion and the progress of design in carriage outlines. No longer dependent upon the curvilinear girth of timber for the production of the curved lower lines of the body-frame, in which parts absolute rigidity is required, the coach-builder forms them of any desirable shape, and judiciously trussing the wooden frame with edge-plates of iron, obtains all that is necessary with the smallest possible amount of material, and consequently of weight. The trussed girder of house and bridge architecture, being of regular form, admits of ready calculations to determine the necessary strength; the trussed girders of carriage-bodies, or in technical phrase, the "bottom-sides," are of almost every conceivable curve, and furnish elements not readily submitted to calculation. In this, therefore, as in most other parts of carriage construction, practice and experiment furnish the data for further progress, and thus it happens that, while carriage-building supplies many beautiful examples of mechanical art, it is seldom referred to by writers on applied science. In fact, its very difficulties, and the complicated and varied strains to which its productions are exposed, remove the art of coach-making from the domain of scientific speculation, and leave it to the common-sense and judgment of its special practitioners, who, because their art is so little talked about, are scarcely aware of its intrinsic beauty, both scientific and artistic.

Without going further into details which must necessarily be discussed in our future numbers, we think we have said enough to show that the carriage manufacture may justly claim to take high standing among the industrial arts; and while, on the one hand, it may be considered an "art-manufacture," it has, at the same time, some right to take rank with the more scientific calling of the engineer.—*Carriage-Builders' Art Journal.*

A BEAUTIFUL SENTIMENT.—The cloudy weather melts at length into beauty, and the brightest smiles of the heart are born of its tears.

For the New York Coach-maker's Magazine.

THE GEOMETRY OF CARRIAGE ARCHITECTURE.

BY A PRACTICAL COACH-MAKER.

PART EIGHTH.—BODY CONSTRUCTION.

The accompanying diagram, Fig. 1, represents a full caleche. (See plate 10, vol. I.) It shows the construction of the body with the bows in their proper position, and the dotted lines give an idea of the form of the shutter-frames. We do not expect that every body-maker can take hold of a job like

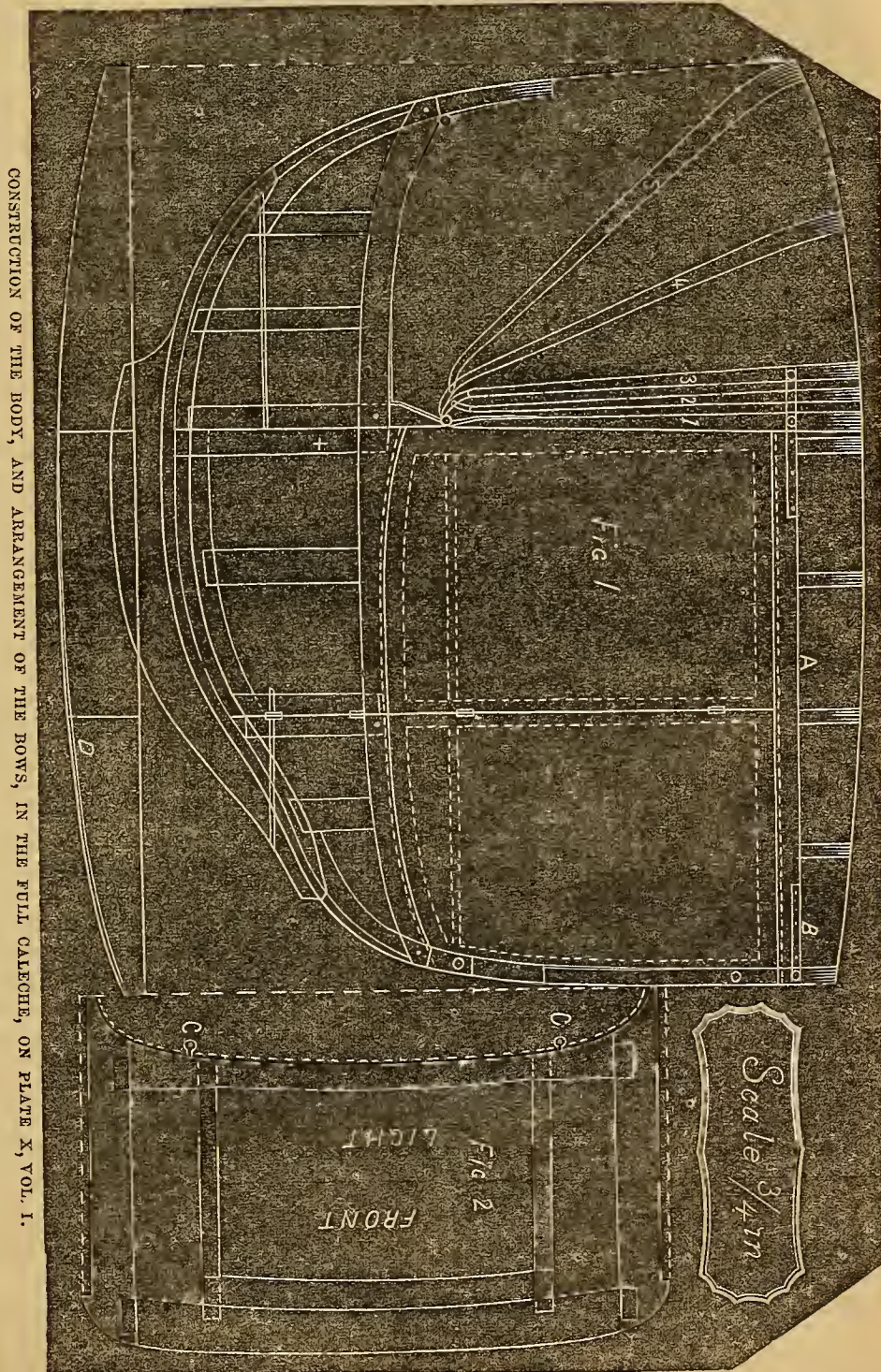

this, and perfect it in all its intricate points from instructions here given; but it will place a man on the track of how it should be constructed. There are a great many points in a caleche which require to be strictly observed, and which can be obtained only by experience, and there are not many men

foolish enough to undertake a job of this kind unless they possess some knowledge of the peculiarities of the job. The three upright bows are all of the same width, and they must range with the outside of the body. The fourth and fifth bows must contract to suit the swell of the body. The width of the fifth bow from centre to centre of the corners, must be as wide as the back. The top of the back-bow should be left stout, so as to receive the strain from the back-leather. The front-bow should be let run up the width of the standing pillars as

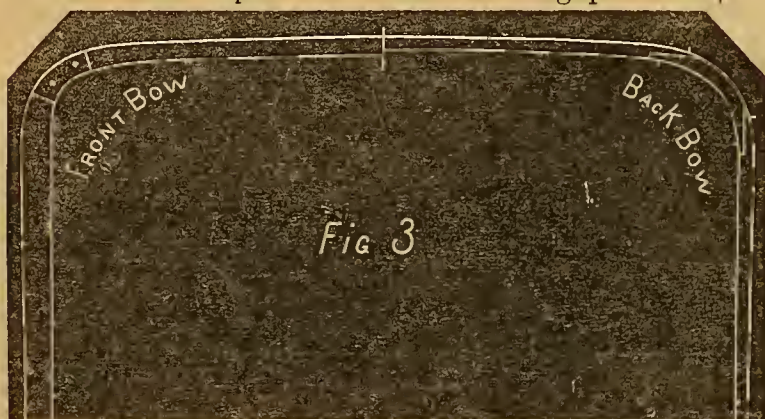

shown in Fig. 3, which also shows the manner of splicing the bows. After the bows are all finished, the corners should be carefully canvassed, to prevent the splices from starting. The front roof-bows may be made of wood or iron, wood is preferable on account of trimming. The side-rail A, is attached to the front by a short tenon and strap-iron B, with a thumb-screw, and also with a strap-iron and thumb-screw in the first and third bows. As the third bow receives the prop-joints, it is necessary that the strap-iron should extend to it, to keep every thing in its place. Fig. 2 shows the front frame, which is attached to the body with a guide pin in the centre, and two thumb-screws through the eyes, *c c*, which are screwed on the frame under the panel. The dotted line on the bottom is the panel projecting to cover the joint. The dotted lines on the side, is the thickness of the shutter-frames. The front-light can be made of any size to suit the fancy. The side-rails ought to be made a little flatter than the swell of the body—about  $\frac{3}{8}$  of an inch—as shown on the kant-board. The object of this is to give a strain to the door-shutter, and have it strike on the top when shut, otherwise it will rattle.

## The Home Circle.

For the New York Coach-maker's Magazine.

### THE OUTLAW'S BRIDE.

A SKETCH FROM THE UNWRITTEN REMINISCENCES OF AN IRISH REBEL.

(Continued from Page 87.)

"A GREAT blessing, such foin weather for travelin'; it don't bring hon rheumatism hor the hasthma," says our English acquaintance, after a ten-minutes pause, and of course without a word as to the means of avoiding the curse of the next station.

"Pains and penalties enough, nowadays, without any assistance from the weather office. We never think of the 'pothecary in these parts, though we sometimes find a job for the coroner."

"More haccidents than diseases—hif hi hunderstood ye. Do ye hoften hupset the coach?"

"Not more than two or three times a week; but people traveling on the Queen's business have sometimes an awkward fashion of sliding off the roof."

"Ow far is the next station?" eagerly demanded the personage thus suspiciously addressed, vividly recalling the words, "pains and penalties," and mentally connecting them with the pointed allusion to the Queen's business.

"Five miles from the last cross-roads!" shouted half a dozen together.

"Stop! stop!" roared the inquirer. "Hi'll take han hinside seat—han hinsid seat, sir, hand pay the difference. I pray ye, stop, sir."

"Pray for yer sowl, this minnit," was the charitable admonition of such a majority of his fellow-"outsiders," as must have fully convinced the subject of their spiritual anxieties that he was more than suspected of some sort of a connection with government persecution in Ireland—in short, that he was a detective.

"In the Queen's name," says he, evidently gathering desperation from despair, and as if resolved, if perish he must, to die in a frenzy of British loyalty, "hin the Queen's name, I command ye to stop."

"We carry the Queen's mail," was the joint response of the crowd.

"Gee up, Blackbird! On your legs, there, Bess! Wide-awake, Jem! earn your oats, blind Gilligan! Go it, ye cripples—keep your time, there, or your carcasses to the club, and your hides to the tan-yard."

Three cracks of the whip accompanying this animated outburst of professional jargon, but too plainly indicated the effect produced upon the autocrat of the "box" by the appeal of Her Majesty's servant to the authority of the British crown.

By this time the terror of our muffled incognito had reached the point of cold perspiration; looking at the augmented rate of speed, the ten mortal feet which represented his elevation from the road, and connecting both with a certain ghastly vision in the shape of the county coroner, his alarm proved the mother of a new experiment, and the result was a proof that the name is not always as omnipotent as the image of royalty. To be plainer yet, the production of a guinea, in sterling specie, at once brought the vehicle to a stand; and, transferring himself to an inside seat, he lost no time in commencing a circumstantial narrative of his outside perils and escape, to the only individual then and there in a condition of waking consciousness; the young lady doubtless recollected by the reader as having taken her place at Athlone. To save all further confusion of persons, genders, and individualities, that young lady was—myself!

Talking once more in my own proper person, I must here confess to an absence of discrimination which had well-nigh frustrated a plan for my escape, which presented one of those happy combinations of dexterity and daring, of which woman alone is capable; and which had thus far been attended with the most flattering success. My *disguise* was perfect. The ingenuity of Baba, in arranging the toilet of Don Juan for his adventure in the Turkish harem, was exceeded by that of Carolone in preparing me for an escape from the mountains of Tipperary. Ringlets, broaches, ear-rings, veil, drapery—all was of her conception and providing; and I believe I may say, without

egotism, that seldom did the masculine gender present a more promising subject for the apparent transformation, or one more likely, so far as external indications were concerned, to effect the necessary delusion which it was our common object to produce. Had it been otherwise—had the contrivances of art been less in harmony with natural appearances—the test about to be encountered, would have proved as fatal as it was unexpected.

The new companion of my journey, whose unpopularity overhead, had, according to his own account, all but resulted in the most disastrous consequences to his person, would certainly have inspired me with a sort of sympathy, by the story of his threatened misuse, had not the loud and ringing laugh which accompanied his descent from the "box," carried with it an assurance, at least to me, that whatever had been transpiring among the occupants of the "roof," the whole thing was nothing worse than one of those pieces of comic jocularity occasionally played off among the episodes of Irish stage-coach experience, upon some involuntary martyr of harmless persecution, merely to beguile the measurement of the road. "If ignorance is bliss," it might have been called especially so in my case. I was entirely unconscious of the suspicions to which my worthy acquaintance was indebted for those significant allusions to "the Queen's business" and the county coroner, as officially identified with the personal prospects of her Majesty's reputed servant, which had rendered the transfer of his person to an inside seat, a matter of such urgent and particular necessity. Upon the subject of his dangers and escape, the *hintervention of Providence*, and all that, he was communicative to a degree; but as to the suspicions which had linked him with the interests of "the Crown," and that in the most ignominious capacity connected with the preservation of that talismanic bauble, he was, to borrow an illustration from Sheridan, as silent as Bob Acres' "coach-horse."

It will, therefore, be easily understood that—finding him a man of average intelligence, respectful manners, and strictly observant, in general propriety, of every thing due to the presence of a lady—I had no intelligible grounds for the slightest objection to his society. On the contrary, his candid though uncalled-for explanations of his domestic position, without a single reference to the public events then forming the absorbing topics of the day, inspired me with a certain degree of confidence; in short, I regarded it as an omen of good fortune that I had thus accidentally fallen in with so obliging a stranger.

My friend (!) had got married about two months previously—resided in Liverpool—spoke of his wife in terms of laudation, respect, and affection—regretted that duties and engagements of an imperative nature had just involved an absence of more than three weeks from home; and finally assured me of the pleasure which it would afford him, provided my journey extended so far, to have an opportunity of presenting so amiable a young personage as myself to Mrs. Ferguson, at Vauxhall Road, Liverpool, such being the name and residence of his newly acquired help-mate. On my part, every thing seemed propitious—I was going straight across the Channel—was the wife of a young officer serving in Canada—was proceeding to take passage for Quebec, for the purpose of joining my husband at Toronto—had sent on my luggage in advance—was entirely alone and unprotected—had a chance to meet a friend or two, for the voyage, in Liverpool—thanked him for his courtesy, and had not the slightest objection to the favor of an introduction to Mrs. Ferguson.

Our acquaintance, that of the Englishman and myself, had gradually ripened, through a night of excessive stupidity, aggravated by the aristocratic drowsiness or reserve of our fellow-travelers, into the foregoing proffer and acceptance of courtesy, when we were admonished of our arrival in Dublin by the incessant sounding of the guardsman's horn, and finally by the halting of the coach, in front of the General Post-office, Sackville street. Here, emerging into the light of a gray autumnal morning, with an air of modesty not always found in connection with feminine habiliments, I stood a proscribed and gazetted "rebel," in the very heart of the Irish metropolis.

My exposure to the stare and scrutiny of the assemblage then and there collected, would, I own, very soon have exhausted my stock of effrontery; but the blunt assiduity of the worthy Mr. Ferguson promptly relieved my anxiety to escape from this ordeal of concentrated observation. Seizing my valise, and hurrying it and myself into a covered "cab"—a style of conveyance peculiarly suited to my purpose—he at once added his own person to the contents of the vehicle, with a command to the *jehu* of the concern to drive to the North Wall. This, perhaps, was the first occasion upon which I became thoroughly alive to the awkwardness of my situation: at least it brought the pangs of momentary self-reproach for having thus incautiously consigned myself to the guidance of a stranger!

A drive of five minutes landed us at the gangway of a huge steamer, belching from her black funnel the fiery indications of her approaching departure; and Mr. Ferguson at once conducted me on board, amidst the deafening uproar of a not very incongruous aggregation of drovers and porters, pilots and pig-boys, mules and mariners, hogs, kine, and not a few of the vigilant guardians of the British revenue; and, to complete the classification, a sturdy platoon of her Majesty's "loyal" conservators of the peace.

"Cast off the hawser, and haul in your fenders." At these words my heart for a moment sank within me! They were the signal of my separation from my native land; and the reality of that event was attended by emotions which predominated over all my anxiety for the success of so important a step in my escape from the perils which had surrounded me within her borders.

Two short hours, and I saw Ireland no more—except in the visions of the past. Howth's proud promontory, with its granite face, its eleven hundred feet of sheer perpendicularity, its baronial castle and Druid's Altar, was but a speck on our horizon; and Dalkey Head was indistinguishable amidst the clouds which formed the morning—to me it seemed the *mourning*—drapery of the Wicklow hill-tops, from Dunleary to Lugnaquilla.

(To be continued.)

SPUNKY.—A renegade husband is thus advertised by his deserted spouse in Chautauque county, New York:

LOST, STRAYED, OR STOLEN—An individual whom, in an unguarded moment of loneliness, I was thoughtless enough to adopt as my husband. He is a good-looking and feeble individual, knowing enough, however, to go in when it rains, unless some good-looking girl offered her umbrella. Answered to the name of Jolin. Was last seen in company with Julia Harris, walking, his arm round her waist, looking more like a fool, if possible, than ever. Any one that will catch the poor fellow, and bring him carefully back, so that I may chastise him for running away, will be asked to stay to tea by

HENRIETTA SMITH.

For the New York Coach-maker's Magazine.  
THE SUMMER IS FADING.

BY ABBEY C. DEAN.

YES, summer, bright Summer, I know thou art fading,  
Thy glory is passing away from thee now;  
Yet I breathe not a murmur, no feeling of sadness  
Oppresses my heart or o'ershadows my brow.  
When the opening buds, and the bees' low humming,  
Were tokens to all that thy foot-fall was near,  
I gave not a smile to welcome thy coming,  
Nor shall thy departure be marked by a tear,  
As in summers gone by.

Other summers, no brighter, have come, and I hailed them  
With smiles on my lip and a song in my heart;  
When their loveliness faded, with tears I bewailed them,  
Such as only from feeling's deep fountain can start.  
But those summers which came, my young spirit renewing,  
Waking joy in my heart that no music could tell,  
While they showered on my pathway their roses, were strewing  
The beautiful blossoms of Hope as well.

Oh! those summers gone by!

And others, still others, have flung down their roses,  
And cast all their glories from off every bough,  
While I heaped up that grave in the heart, where reposes  
The love that was mine, but is "lost to me now."  
When the heart is a tomb where a lost love is lying,  
No feeling of gladness will thrill through it more;  
Then well might I weep when those summers were dying,  
For never could Time, what they buried, restore—  
Oh! the summer is gone!

But why should I weep when *thy* brief season closes?  
*Thou* didst bring me no hope-buds to garland my brow;  
I bid thee not linger—go, fling down thy roses—  
And strip all thy glories from off every bough!  
Summer, bright Summer, full soon thou art fading,  
Thy glory is passing away from thee now;  
But I breathe not a murmur—no feeling of sadness  
Oppresses my heart or o'ershadows my brow—  
Save for summers gone by!

For the New York Coach-maker's Magazine.  
WHAT I WANT.

BY MISS E. C. S., OF NEW YORK.

WANTED, a hand to hold my own,  
As down life's vale I glide;  
Wanted, an arm to lean upon,  
Forever by my side.

Wanted, a firm and steady foot,  
With step secure and free;  
To take its straight and onward pace  
O'er the path of life with me.

Wanted, a form erect and high,  
A head above my own;  
So much, that I may walk beneath  
Its shadows o'er me thrown.

Wanted, an eye within whose depths  
My own might look, and see  
Uprisings from a guileless heart,  
O'erflown with love for me.

Wanted, a lip whose kindest smile  
Would speak for me alone;  
A voice whose richest melody  
Would breathe affection's tone.

Wanted, a true religious soul,  
To pious purpose given,  
With whom my own might glide along  
The road that leads to heaven.

## Pen Illustrations of the Drafts.

TRIPLE PHAETON.

Illustrated on Plate XVIII.

BRIDGEPORT, CONN., Sept. 27, 1859.

THE accompanying drawing is a design for a three-seat phaeton, which would look extremely light. The back is hung on platform springs, supported by an iron loop, or crane-iron, which reaches to the centre of the back cross-spring (as seen in fig. 1), in the blacksmithing department. The footman's seat is supported by an iron stay from the top of the spring, as seen in fig. 2. The side wings are a great improvement on a carriage of this kind, in appearance, combined with utility. The striped painting would show off the pattern of the body more than any other kind. It would also have a rich appearance if not done too gaudy. Black and lake, or green, would be preferable to any other colors, with a very fine stripe of a lighter shade. To make a close carriage for two, out of this, I refer you to the trimming department. A phaeton of this kind can be used in a variety of ways. The driver's or footman's seat, or both, can be taken away, and leave a very stylish-looking carriage then.

JOSEPH IRVING.

FANCY BUGGY.

Illustrated on Plate XIX.

For some portion of the details in this buggy, we are indebted to our friend Mr. Nelligan, of Tennessee. We have, however, made such alterations in it, as to give a degree of originality to the whole draft, and believe it possesses novelty sufficient to recommend it to the attention of our readers.

The arched portion of the body may be constructed of a sectional piece of wheel-rim, and carved as in the design, or left plain, the space between the body proper and this arch being finished with caned-work, rendering it light in reality as well as in appearance. The seat is secured to this arch by iron braces, scrolled and plated. A plated rail passes around the seat-rail. We are so well pleased with this ourself, that we have no hesitation in recommending it as "something nice."

PEDDLER'S WAGON.

Illustrated on Plates XX. and XXI.

We have frequently been requested to furnish a draft of a Peddler's Wagon, and through the kindness of Messrs. French, Spalding & Shepley, we are now enabled to do so. The design of it is by Mr. W. S. Hoyt, of Ithaca, N. Y., who, we are told, "is every inch a gentleman, and an ornament to the craft." The following details in relation to its construction will be found useful. They are by Mr. Samuel N. Spalding, one of the firm named above, who also executed the draft.

BINGHAMTON, N. Y., Sept. 11, 1859.

MR. STRATTON: *Dear Sir*—When you was at our place we promised to send you a draft of a Peddler's Wagon. I have drawn one  $\frac{1}{2}$  inch to the foot, which I inclose to

you for publication, should you think it looks well enough to exhibit before our craftsmen. The body is 9 feet 6 inches long; 2 feet 5 inches high, and 3 feet 3 inches wide, including the mouldings and panels; the panels and moulding being each  $\frac{1}{2}$  an inch thick, by 1 inch wide; toe board  $18\frac{1}{2}$  inches long; seat from the toe-board  $13\frac{1}{2}$  inches high (indicated by the dotted lines) and 19 inches wide. The body-sills are  $3 \times 1\frac{3}{4}$  inches; top-rail  $1\frac{1}{4} \times 1\frac{3}{4}$  inches; the centre-pillar and the centre-rail each 1 inch square. Wheels—Hubs 7 x 9 inches; spokes 2 inches; felloes 2 inches deep; tire  $1\frac{1}{2} \times \frac{5}{8}$  inches; front wheels 3 feet 6 inches; hind do. 4 feet 2 inches. Axles  $1\frac{5}{8}$  inches. We "crank" the axles very little. The side-springs E E are from 2 inches steel, with 7 leaves 44 inches long; cross-springs G 42 inches long. This wagon is capable of carrying 1,800 pounds. This is drawn with a gipsy-top, but we generally make them close.

I have also sent a diagram of the front running part, only; the hind-part being very simple and easily made. You will perceive that this is made different from the old way of omnibus-gearing, and is better and cheaper. In the first place, get out your futchells F F, in the shape seen in the cut on plate XXI. If your cross-spring G is 42 inches long, your splinter bar A, ought to be 47 inches; and if your side-springs E E, are 44 inches long, get out your futchells, F F, 4 feet 3 inches long, and from 2 inch hickory plank. The side-braces B B, should be made of good ash  $1\frac{3}{4}$  inches square; and the front splinter bar A, of the same,  $1\frac{7}{8}$  inches thick, leaving it  $1\frac{1}{2}$  inches at the middle, reducing it at the ends where the side-braces B B, are framed in, down to  $1\frac{3}{8}$  inches. The splinter bar rests on the top of the futchells; the braces B B running back with the futchells rest on a spring-bar. Under your futchells it will be necessary to put a bar of iron  $\frac{5}{8} \times 1\frac{1}{4}$  inches, so as to prevent their springing. Your futchells will be  $2\frac{5}{8}$  inches deep, including the iron bar, while your wood brace is only  $1\frac{3}{8}$  thick, consequently you will have to let the futchells into the spring-bar  $1\frac{1}{4}$  inches, where they rest upon it.

The centre-piece C, should be made of hickory also,  $2\frac{1}{2}$  inches wide and  $1\frac{1}{2}$  deep—let that rest on top of the futchells F F and braces B B. Notch out the cross-piece c so as to lay level, placing the centre of this cross-piece 4 inches back of the axle D (some say 6 inches), so as to make the wagon turn short. We think that about four inches "cramp" is the best. The fifth-wheel is of  $1\frac{1}{2} \times 1$  inch rim, 2 feet in diameter. The paint on body, Chinese vermilion, and the running gear straw color, striped black, and ornamented similar to that in the draft.

Yours truly, S. W. SPALDING.

### Sparks from the Anvil.

For the New York Coach-maker's Magazine.

#### A REMEDY FOR A GREAT EVIL.

MEDINA, O., August 5, 1859.

FRIEND STRATTON—I have noticed on all buggies partly worn, that the iron running from the fifth-wheel, where it connects with the reach to the bottom of the axletree on to the king-bolt, gets very loose and wears away the bolt very fast. In order to do away with that difficulty, I cut the screw on the bolt, close up to the axletree, and put on a thin nut there, the iron and another nut below making it solid, which prevents wearing and

rattling both. If you think this will be of any use to the craft, you can give it an insertion in your valuable Magazine. E. B.

For the New York Coach-maker's Magazine.

#### IRON WORK TO THE TRIPLE PHAETON ON PLATE XVIII.

FIG. 1 represents the ground plan of the back of the triple Phaeton on Plate XVIII., given with this number. A A exhibits the body-loops taking the back-cross-spring B,

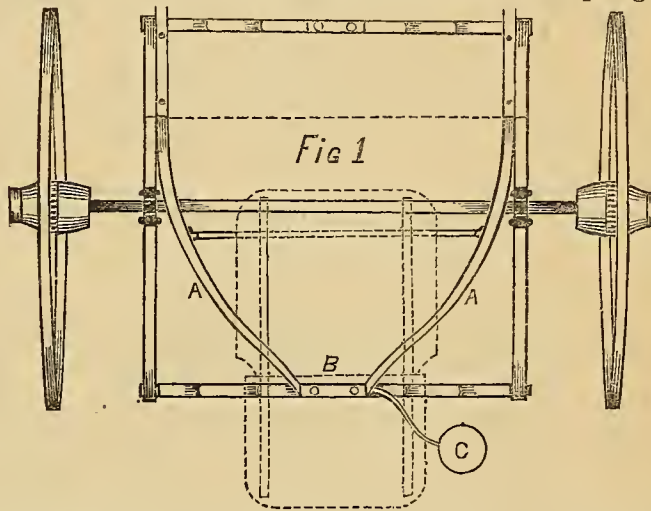

where also is attached an ascending step, C. The dotted lines are made to represent the footman's seat and foot-board.

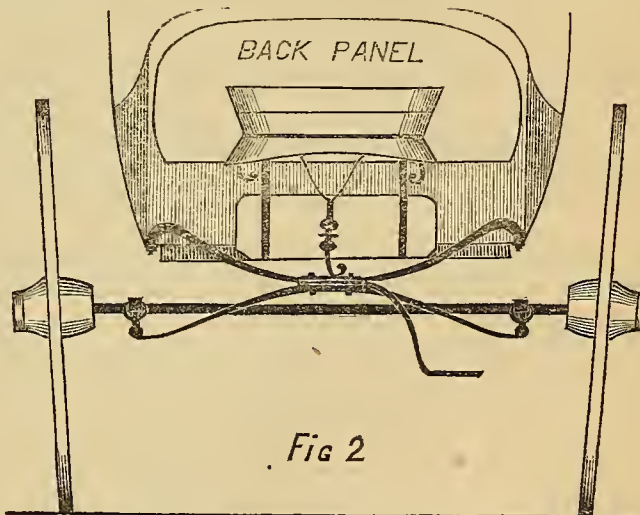

Fig. 2 gives a back view of the Phaeton, with the footman's seat supported by a back-stay, which is formed like unto a T, and bolted over the top of the spring, over the loop-iron. J. I.

#### TESTING THE QUALITY OF STEEL.

THE good quality of steel is shown by its being homogeneous, being easily worked at the forge, by its hardening and tempering well, by its resisting or overcoming forces, and by its elasticity. To ascertain the first point, the surface should be ground and polished on the wheel, when its lustre and texture will appear. The second test requires the giving it a heat suitable to its nature and state of conversion. The size and color of the grain are best shown by taking a bar forged into a razor form, hardening and

tempering it, and then breaking off the thin edge in successive bits with a hammer and anvil. If it had been fully ignited only at the end, then, after the hardening, it will display, on fracture, a dissimilarity in the aspect of its grains, from that extremity to the other, as they are whiter and larger at the former than the latter. The other qualities become manifest on filing the steel, using it as a chisel for cutting iron, or bending it under a heavy weight. Kinman long ago defined steel to be any kind of iron which, when heated to redness, and then plunged into cold water, becomes harder. But several kinds of cast iron are susceptible of such hardening. Every malleable and flexible iron, however, which may be hardened in that way, is steel. Moreover, steel may be distinguished from pure iron by its giving a dark gray spot when a drop of dilute nitric acid is let fall on its surface, while iron affords a green one. Exposed to the air, steel rusts less rapidly than iron.—*Scientific American*.

## Paint Room.

For the New York Coach-maker's Magazine.

### THE REASON WHY VARNISH CHANGES BY STANDING, &c.

FRIEND STRATTON—Agreeably to your request, I will now give you something of my experience in respect to varnish, in its turning white, gray, cloudy, &c. All the principal ingredients in varnish are vegetable—gum, oil, and spirits of turpentine. Now, it is well understood that most all kinds of gum, and that linseed-oil in particular, will turn white when it is exposed to water. Polished steel, or brass, will rust if long exposed to rain, or a damp atmosphere. In fact, there is no manufactured article that will not be injured more or less by exposure to the storm. No varnish, not even the English, or wearing-body varnish, but will spot or turn white when long exposed to rain, mud, or damp weather. Varnish, however, is expected to stand what no other manufactured article will. Is this reasonable?

Let us put into use a little common-sense, and do with our carriages as we do with our harnesses, wearing apparel, and other goods, and the difficulties as respects our varnishes turning white, will soon vanish. Should a man put his finger into the fire, it no doubt would be burnt, and should a man run his carriage into the water, or expose it to a long-continued storm, it *must* turn white, green, blue, or spot. Now, where are we to find a remedy? Use varnish as you would your coat, hat, or any thing else, *with care*. But if you must use your carriage in the rain or mud, wash it off, immediately after using, with clean, cold water, and wipe it dry with a chamois, and if practicable, run it into the sunshine, or a warm room, and nine cases in ten the varnish will regain its original gloss. But as in most cases, a carriage is left for days covered with mud! Nothing, not even polished steel, would stand such unfair usage. A carriage used in wet weather, or exposed to dampness before it is thoroughly dry, is sure to spot or turn white, and a large majority of the cases in which the varnish turns white, &c., is because the carriage is used before the varnish is thoroughly dry.

Now for the gray part of it. There are two causes. A man having purchased a fine carriage, he puts it in his carriage-house. This carriage-house is connected with his stables. The steam, gas, or miasma arising from the horse-

manure and urine there collected, will soon entirely destroy the whole life of not only the varnish, but the color of the paint, and turn it gray in a few months, so that you can brush it off in fine powdered dust; or secondly, if the carriage-house is not connected with the stable, if it is built of brick, it will be damp. I have seen carriages in positions where they have not been connected with any stable, where the varnish on the back-panel and one side, was all destroyed and gray, while the front, and the other side, was bright and good. The cause of this was dampness alone from the brick walls.

Another fact. An extensive livery-stable keeper in your city showed me some carriages, all varnished with the same varnish. Part were in a carriage-house as above, and another part were under an open board shed. The former were all gray, and the latter all bright and good. These had all been varnished within a month of each other.

It is not an unfrequent thing for a coach-maker to wash off his carriage with *hot water*. This will kill the life of the varnish, so that it will soon lose its gloss, and turn gray. Should the carriage be properly built, and dry before using, and used in mud and rain and immediately washed off and sunned, or put in a warm room, and kept from the horse-manure, and not washed off with hot water, but kept in a wooden carriage-house, or a brick one furred and plastered, so that there will be no dampness, you would seldom hear any complaint of having varnish turning white, gray, or spotted.

The reasons why varnish becomes smoky, cloudy, &c., are very easily explained. First, if the paint and varnish are not dry—I care not how dry your repository may be—it will sweat out, leaving the body dull, smoky, and cloudy. But suppose every thing generally is right, yet the carriage is put into a brick repository which is not plastered, but is damp; the dampness soon settles on it, destroying its gloss, partially, so that it becomes cloudy and smoky, the natural result of this moisture. The remedy is in having a dry repository; but if damp, wash off the carriage at least twice a week, with pure cold water. Every day would be better still. Washing will not injure it: depend upon it, it will remove all smoky appearances. My dear sir, do you believe that if you were to be confined in a damp repository for a month or two, and not washed off, that you would remain bright and lustrous? [Certainly not; we "go in," decidedly, for the *washing off*.—ED.]

In conclusion: Is it reasonable, right, or common-sense, to suppose that an article made of vegetable substances, as delicate as varnish is, and so liable to be abused, should remain unchanged under unfair treatment, and have more expected of it than of almost any other manufactured article? Would you not benefit those who use varnish, by publishing these three articles in one number of your Magazine, as a convenient reference?

OLD FOGY.

For the New York Coach-maker's Magazine.

### WEARING BODY VARNISH.

MR. EDITOR—Within a few years many complaints have been made respecting Wearing Body Varnish, and it occurred to me that something published in your valuable Magazine would be serviceable to your subscribers on that subject.

DIRECTIONS FOR THE USE OF WEARING BODY VARNISH.

As this varnish is essentially different from any other

coach varnish, the circumstances and mode of application will be different.

It is almost exclusively used for the last or flowing coat, and unless care is taken, and the following instructions strictly adhered to, it will not answer the purpose intended.

1st. It should not be laid on over work not thoroughly dry; if it is, it will flat and dry dead, with very little gloss, or crinkle, crawl, or pit. The varnish underneath not being dry, but damp, will cause one or all of these results.

2d. It should be laid on in a warm room, well sprinkled, and swept clean, and the temperature never allowed to go above 80 degrees, nor lower than 60; and this temperature should be kept up, and the work not removed until thoroughly set—in fact, not under 24 hours—48 is better. A temperature above or below those named, will impair or entirely destroy the gloss.

3d. It should not be laid on where there is a current of air blowing on it, nor put in that position until set—if this is done, it will dry dead, without a gloss.

4th. It should not be laid on heavier, on running parts, or a heavier coat put on, than is put on a body. If this is done, the varnish will run, and where it runs, it will crawl and shrivel up in places, while the rest of the job will be smooth. The running parts should be varnished in the same room as the body, or one equally warm, and the same rules observed as in varnishing a body.

OLD FOGY.

#### JAPAN VARNISH.

ACCORDING to Thunberg, the very best Japan varnish is prepared from *Rhus Vernifera*, which grows in great abundance in many parts of that country, and is likewise cultivated in many places on account of the great advantages derived from it. This varnish, which oozes out of the tree on being wounded, is procured from stems that are three years old, and is received in some proper vessel. At first it is of a lightish color, and of the consistence of cream, but grows thicker and black on being exposed to the air. It is so transparent, when laid pure and unmixed upon boxes or furniture, that every vein of the wood may be seen. For the most part a dark ground is spread underneath it, which causes it to reflect like a mirror, and for this purpose recourse is frequently had to the fine sludge, which is got in the trough under the grindstone, or to ground charcoal; occasionally a red substance is mixed with the varnish, and sometimes gold leaf, ground very fine. This varnish hardens very much, but will not endure any blows—cracking and flying almost like glass, though it can stand boiling water without any damage. With these the Japanese varnish the posts of their doors, and most articles of furniture which are made of wood. It far exceeds the Chinese and Siamese varnish, and the best is collected about the town of Jesino. It is cleared from impurities by wringing it through very fine paper; then about a hundredth part of an oil called *toi*, which is expressed from the fruit of *Bignonia tomentosa*, is added to it, and being put into wooden vessels, either alone or mixed with native cinnabar, it is sold all over Japan. The expressed oil of the seeds serves for candles. The tree is said to be equally poisonous with the *rhus vernix*, or American poison-tree, known as swamp-sumach.

GOSSIP FOR THE PAINT-SHOP.—Under this head we shall commence a series of articles in our next number, from an Eastern correspondent, of much interest.

## Trimming Room.

For the New York Coach-maker's Magazine.

### ARRANGEMENT OF FOLDING LIGHTS TO THE TRIPLE PHAETON.

Fig. 1. In this diagram is shown the manner in which a close carriage may be made of the triple phaeton, by applying folding-lights. These lights are so constructed as to fold with the size of the upper glasses, A A, and but-

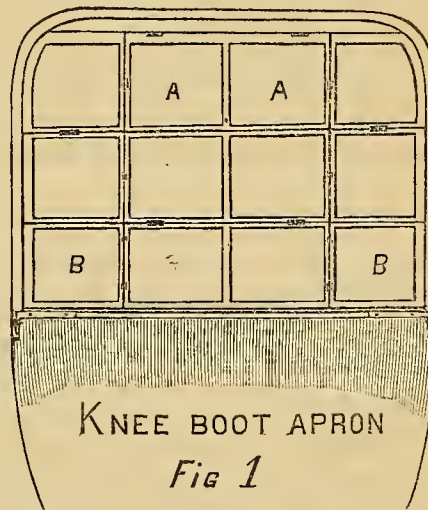

ton up to the second bow. In the first place, there is a wooden valance required for the front bow. On the top there should be a strip of ash  $\frac{5}{8}$  by  $1\frac{1}{2}$  inches wide, fastened inside of the valance. To this piece the frame is attached with slip-hinges, so as to allow the frame to be taken away at pleasure. In folding the frame, the three side lights turn in (or they may be left entirely open for ventilation, or the bottom lights may be opened for the same purpose), then the three centre ranges turn up, one against the other, finally fastening up to the front bow.

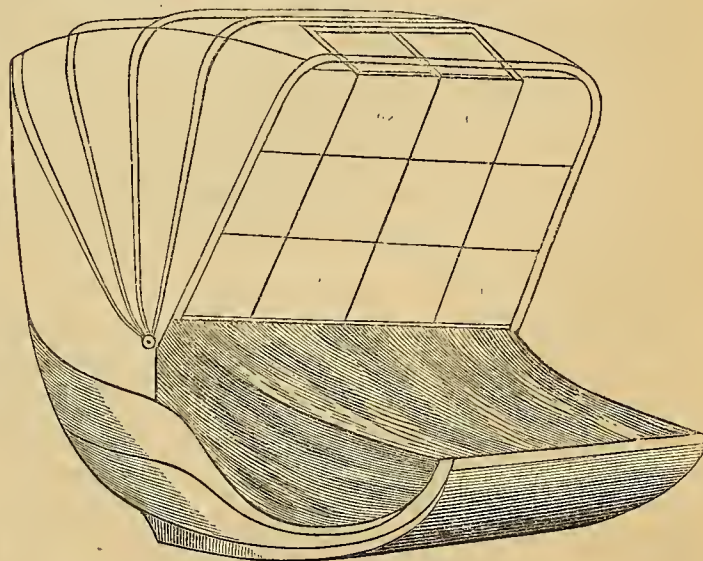

Fig. 2 presents a perspective view of the body, with the folding frame attached and fastened up, out of the way.

When not in use the knee-boot apron will require a small rail for the frame to shut against. This rail will require a hook at each end, to drop into an eye screwed on to the front bow, as shown in the diagram. J. I.

#### THE PATENT BASSELAIN LINING-NAIL.

SOME might suppose that so small an article as a lining-nail was too *small* a subject to write about, and so it would be in ordinary cases; but the patent lining-nail of the Ives & Pardee Manufacturing Company, at Mount Carmel, Conn., is something extraordinary, and is so entirely different from any thing before known, that we cannot well resist the temptation of going a little further into the subject than is required in an ordinary business notice, which will be found in our advertising department.

The common black-japanned headed nail answered a very good purpose in its day, but was rather too plain an article for a "fancy" customer, while, on the contrary, the silver-headed nail was a little too *dashy* for a plain gentleman, and the ivory-headed one was a little too brittle and "Miss-Nancyish" for anybody. The patent Basselain lining-nail above named seems to be the very thing accommodated to all tastes. It is just "silvered" enough to be pretty, and yet "black" enough to be *tasty*. We will endeavor to describe it. Imagine to yourself, kind reader, how a small silver-headed name-plate nail would look driven through the centre of the head of an ordinary black nail-head; and should your impressions be correct, you will receive the exact idea. Should you wish to prove the correctness of your ideas, send for the article, and we are satisfied you will admit this lining-nail to be the *ne plus ultra*.

THE INDIA RUBBER WHIP SOCKET.—Our friend Munson, whose advertisement may be found in another part of this Magazine, has added several new sizes to his catalogue, so that now purchasers will have an opportunity to select, so as to suit all fancies. The prices too, have been materially lessened, and the colors have been so improved as to present a glossy jet black, a desideratum never reached before in this kind of goods. A revised scale of prices will be given in our December number.

MACHINE FOR MAKING WHEELS.—A practical wagon-maker, in Warren, Pa., has recently invented and put in operation a new machine for making wheels, whereby much labor is saved. A piece of oak, or any other suitable timber, is placed in the machine, and turned out a hub in a few seconds. Another part of the machine bores and mortices the hub, and as it still remains in its position, the spokes are driven, and by a single change of tools a tenon is cut on the end of each spoke. This same machine bores the felloes, and after being placed in their proper places, the wheel is turned off smooth and complete. The *Warren Ledger* says, that this entire invention is wonderfully simple, considering the various work it is capable of doing.

## The New York Coach-Maker's Magazine.

NOVEMBER 1, 1859.

E. M. STRATTON, Editor.

#### TO READERS AND CORRESPONDENTS.

PUBLISHER'S NOTICE.—As the conductor of this Magazine is determined to make it as useful and interesting as possible, a general invitation is given to all in the different branches of the profession, to contribute to the different departments of the work, such improvements or new features as they may be cognizant of, anywhere in the United States, and when such matter is charged (if used) it will be liberally paid for. We hope that none will be deterred from writing or sending us sketches, under the impression that they cannot write well enough. We take it upon ourselves to properly see to that matter, under the conviction that the purest ore is often found imbedded in the most unsightly rubbish. The craft will much oblige us, if, when patentees call upon them, they would point out to them the superior advantages this work offers for placing their inventions before the craft. In this way much can be done in furthering the objects of this publication.

☞ All letters directed to this office on business, NOT relating to the Magazine, but solely for the writer's benefit, must inclose a stamp; if requiring an answer, two red stamps. Orders for a specimen number must be accompanied with nine three-cent stamps. When these terms are not complied with, no attention will be given them.

N. L. K. & CO., OF TEXAS.—We cannot enlighten you in regard to the hand-mortising and boring machine, about which you inquire.

J. D. M., OF GA.—We supply tube colors to order. The average cost for each tube is 19 cents, but some of the more costly are sold as high as 75 cents.

N. R., OF OREGON.—Balance of subscription has come to hand.

S. R., OF LA.—You have fallen into the too common error of many others—left us to *guess* your former post-office in directing the Magazine to a new one. In changing address, we want the name of the post-office where your magazine was previously received.

K. M. W., OF MASS.—The "seabby trick" served you by your "old friend," is not news to us; but the loss, when value is taken into the account, is comparatively little.

J. S., OF ILL.—The postage per quarter, on this Magazine, for a single subscription, if paid in advance, is 3 cents; when paid on each number, as received, it is 2 cents. Any postmaster charging more does not understand his business.

#### MECHANICAL LITERATURE.

AMONG the many new enterprises that distinguish the present century from all which have preceded it, there is no circumstance more significant than the one, that many of the mechanical occupations of the present day have an organ devoted to their special interest. It is true, mechanical literature has existed in some form for a long period, but rather in a general than with a special treatment of the subject. It has fallen to the lot of the present generation to take up a separate trade, and treat of its mechanical minutiae in detail, and when necessary, to defend its interests against unprincipled and designing enemies, who, like ravenous beasts, prey upon the community under the garb and color of law. Without going further into



this part of the subject, we shall here ask the reader if it has ever occurred to his mind, that in encouraging a publication similar to our own, he is simply placing in the very foreground of his business a Cerberus, which stands as a faithful sentinel to point out the dangers to which it is exposed, and if he be wise, to profit from the alarm and be ready for defense.

Viewed from a literary stand-point, this subject is one of the deepest interest. But a few years ago, and the most distinguished lexicographers defined the mechanic as "a low workman," with which term was accustomed to be associated every thing mean and vulgar. Although prejudice of this kind is not yet entirely obliterated in the minds of the public, yet it is fast dying out, and the period is not far distant, when the mechanic will be assigned his true position among his race, as a man whose usefulness and respectability are of the first order. The present is confessedly a reading age, particularly among the mechanical classes of our countrymen. The ten-hour system presents to every individual opportunities for study and improvement, which, if improved, will have a tendency to elevate us as a class in the scale of human existence. The long evenings with which we are now favored, we hope will be embraced for study, which, in view of the fact that "knowledge is power, is wealth, is honor," should be properly employed in storing the mind with literary treasures, for the mind to live upon in after-life. To the youthful portion of our readers especially, this subject is one of the greatest importance.

Perhaps there is no class of mechanics more favored with opportunities for improvement, literary and mechanical, than the coach-maker. With three regular monthly journals established among the three most enlightened and refined nations of modern times—the *Mercurè Universel*, in France; the *Carriage-Builders'* and *Harness-Makers' Art Journal*, in England; and THE NEW YORK COACH-MAKER'S MAGAZINE, here—the fraternity ought to make rapid progress. The art of coach-making, although of great antiquity, is yet in its infancy. How it has improved in the past fifteen years, is significant of still greater progress. The modern carriage is a wonderful piece of mechanism, challenging the admiration of man, when he reflects upon its gracefulness of form, an embodiment of strength. That it will still further be improved, we have no doubt.

But there are persons who would deny and ignore every benefit we claim for this class of journals, under the sweeping assertion, "Oh! we don't see that a Coach-maker's Magazine is of any use." No, and these same persons "don't see" that information of a literary nature, on any subject, "is of any use." Ask them to subscribe, and they "are nowhere;" ask them to drink that which poisons and degrades them, and they "jump at it." Such is the general

*intelligence* of this class of animals! It will be found that only the ignorant, the besotted, the degraded, are they who in vulgar English depreciate the value of mechanical as well as other publications of the day, and it is gratifying to know that these are fast becoming enlightened, although *their* light is but the reflection from others, or lunar, like that the moon receives from the brighter sun.

It is a received truth, that no one is too well educated to receive further knowledge, and it is presumed that there are but few so indifferent to passing events as not to be interested in them. It is in matters of this kind, that magazines on a special subject commend themselves to a thinking world. We claim, that one new idea obtained from a single volume, is worth, where a man's living is dependent upon his trade, more than the subscription price; and how many such, kind reader, have you gathered from these pages? A moment's reflection, perhaps, will enable you to discover, that a larger portion of the mechanical skill you exhibit to-day, is either directly or indirectly due to the general diffusion of mechanical knowledge, through its numerous serials.

#### THE EDITOR IN CONNECTICUT.

WE have again rambled abroad, this time into Connecticut. On this occasion, we left New York at 3 P. M., on the 14th of September, by the new and elegant steamer John Brooks, for Bridgeport, sixty miles distant from New York, to run which through the Sound occupied three hours and a quarter. The sail up the Sound is by many preferred to the dusty ride by railroad, since this fast steamer takes but a little more time to perform the same travel, and it is done at less than half the expense. Taking the cars of the Naugatuck railway at Bridgeport, we passed on to Birmingham, a place of some importance as a manufacturing town; but very little carriage-making is done there. From this to Seymour and to Naugatuck, where there is one very extensive manufactory of light carriages—that of Messrs. H. Stevens & Co. They were, at the time of our visit, turning out daily "Concord-buggies" for the Southern market. The Naugatuck Wheel Company also have their factory in this place, which is under the direction of Mr. Nelson Fuller. This establishment is furnished with conveniences for making about one hundred sets of wheels per week, of the very best kind. Situated in a section of country growing the finest timber—ash, hickory, and elm—we see no reason why the trade cannot obtain here a good article. They have here a fine wheel-form, of iron, that is the nicest we have ever seen, and which should be introduced everywhere, instead of the old-fashioned lumbering things which, from days immemorial, have crowded our shops.

Our next visiting place was Plymouth, where we found three large establishments, those of Messrs. L. F. Comstock & Co., J. Blakeslee & Sou, and Sheldon & Tuttle. Pre-

vious to this visit, we had no idea that carriage-making was so extensively carried on in this inland town. Here we had the pleasure of making the personal acquaintance of the proprietors, and a few of the journeymen. Among these was Mr. W. F. Boland, whose interest manifested previously in behalf of our enterprise, was on this occasion very advantageous to us. With his generous assistance we were enabled to get a large number of patrons to our work. Mr. Comstock was getting ready a buggy for the fair, that would be creditable to any manufactory in the land. The manufactures of the three extensive factories in this place are well worthy the inspection of such dealers as are purchasing to sell again, either in the New York or Southern markets.

Plymouth is a very pretty place, and was very early in the history of our country settled by the descendants of the Pilgrim Fathers of New England. We have elsewhere in this volume alluded to the "mania" among some of our countrymen, for *digging* to find the pirate Kidd's chest. As another instance of hallucination, we give the following story :

About thirty years ago there lived in the southern part of this town, near the Naugatuck river, one John Sutliff, whose profession was to grind his neighbors' corn, and like many other "millers" of his day, was a man of respectability, but with many singular *notions* in his head. The idea appears to have grown with his growth and strengthened with his strength, that in the bowels of a mountain near his residence he would find by digging, in a state of fusion, gold, silver, &c., which he expected to take up in a ladle. Under this impression he began to dig in the side of the mountain, interrupted only by the rocks and stones, to avoid which his course became circuitous, until he became confused, and instead of penetrating as he supposed into the bowels of the mountain, he was excavating in another direction, immediately under the turnpike road! Some travelers passing in that direction, and hearing the noise underfoot, and curious to learn what was going on, dug down to our enthusiast, who became very angry at his intermeddling visitors. But this interference did not put an end to his "prospectings;" he continued to "dig" a little every day for about forty years, and was only stopped by the infirmities of old age!

From Plymouth we went to Wolcottville, still farther north, to the large and beautiful establishment of the Alvord Carriage Co. Here we had the pleasure of making more acquaintances, that of Messrs. Alvord, sen. and jun. We found them to be gentlemen in the best sense of the word, and left them under such impressions as will doubtless fix their kindness firm in our heart. These gentlemen are in want of a good ornamental painter, and we have only to say that to some of our qualified subscribers, this is an opportunity seldom met with for a good situation.

From this point we returned to our office well pleased with our first visit over the Naugatuck road, and favorably impressed with the hospitalities of our Connecticut friends.

#### FASHIONS IN CARRIAGES.

WITHOUT much perceptible change in the style of our American carriages this season, we may state that the Park Phaeton, or Brett, is the most popular carriage at present in use. It is so well calculated for two or four persons, and, besides, is so light and airy, that pleasure-seekers must, in a climate so enjoyable as ours, always require something of the kind. The time has passed in which persons will submit to being shut up in a close coach, when the chief attractions in traveling are a delightful prospect and pure air. Among the lighter carriages, the buggy continues to be popular, although modified in form from that given in a late number of this work. Wooden boots carefully painted, and bodies very light, shaped very much, in the lower part, like that on plate xix., given this month, are fast taking the places of the bracket and open-front buggies heretofore in fashion. The tastes of this country are decidedly tending to the encouragement of the finest order of work possible, so much so that the common or cheap descriptions must soon vanish from our principal cities.

In England, according to our cotemporary *The Carriage-Builders' Art Journal*, "the sociable Landau is, at present, the favorite. Although one of the most expensive carriages, the number made during this year, and now in progress, greatly exceeds that of previous years. At one time the variety and number of carriages were limited, consequently there was less room for display of taste in their fabrication; but now the varieties are so numerous that it is most difficult even for a practised observer to become familiar with them all.

"Convenience is the first object of the carriage-builder; and his next study is elegance of form. We see unworthy specimens of workmanship occasionally, even in the present day; yet the improvement in taste and skill is manifest to the most casual observer, especially in the productions of the first-class builders, who are now desirous of taking advantage of every improvement. Although we claim for the English carriages superiority over all others, a long and arduous task lies before them. Much requires yet to be done. That this will be achieved we have no doubt, when we consider the many recent and great improvements, combined with the increasing energy, ability, and knowledge existing in the trade.

"Open carriages generally have been more patronized of late, and lightness of draft is more desirable and more suitable for the very light class of horses at present in use."

In France, the coupé and caleche appear to be the favor-

its articles at the present time, although the phaeton, as illustrated in our July number, continues popular.

Before we close this article we have something to say to the editor of the *Mercurè Universel*. We have a great respect for its worthy conductor, but we would remind him that such caricatures as he gives us as carriages *Americaine* are ridiculous in the extreme. They look as if they had been formed, and afterwards, with a heavy sledge hammer in the hands of brawny workmen, at each end, been knocked into a "cocked hat" imitative, for the purpose of seeing how curious they will look. We submit, if this be a fair representation of the productions of us Americans, who are, probably, notwithstanding our English friend's assertions, more chaste and correct in the form of our carriages than any other nation on this earth.

#### LITERARY NOTICES.

*Transactions of the New York State Agricultural Society, 1858, Vol. XVIII.*—Through the kindness of the Corresponding Secretary, B. P. Johnson, Esq., we have been favored with the volume of Transactions above named, the valuable contents of which recommend it to every individual engaged in agricultural pursuits throughout the State. Without attempting a lengthened review, which, did time permit, our circumscribed space would not allow, we shall briefly notice some of the more prominent articles found in the volume.

In the Report of the Executive Committee to the Legislature of New York, under the different heads of Statistics, Steam-Plowing, Agricultural Museums, Journal of the Society, Essays, &c., the reader will find much valuable and interesting matter. The address of Joseph Williams of the Michigan Agricultural College, relative to Agricultural Education, is a masterly performance, as well as that of Prof. North on American Trees and Tree Planters.

The Committee's report on Dairy Farms is of itself worth a fortune to any of our countrymen engaged in supplying the market with good butter and cheese. An article on Draining is so suitably given and illustrated, that it cannot fail to benefit any who are about to redeem their low and moist lands, for the purposes of cultivating.

Mr. Pell's Essay on Fishing (although we cannot see what connection it may have with agriculture, except as a fertilizer) will be found deeply interesting to every true disciple of old Izaak Walton. But that which most interests us is the lengthy Treatise on Fencing, from the pen of our friend and correspondent, S. E. Todd, Esq. How the retired carriage-maker has found out so much about fencing has puzzled us not a little. The illustrations to this article will aid the amateur farmer, for whose instruction our author modestly professes to write, in arriving at a knowledge of one of the most important matters connected with a farm, that must prove valuable to him. Upon the whole, this volume is valuable and useful, and how any farmer can do

without it is incomprehensible to us. Should any of our readers be connected with soil cultivation, we would recommend to them to purchase and study this publication. It cannot fail in repaying the trifling outlay more than ten-fold.

*Life Illustrated.*—We have before called attention to this charming weekly publication, issued from 308 Broadway, by the Messrs. Fowler & Wells, at \$2 per annum. Our friends who may desire a good family paper for these long winter evenings, would do well to subscribe to it. They will find it solid, interesting, and useful. The number for October 29th commences a new volume, presenting a good opportunity for subscribing to those who would preserve their numbers for binding. It is well illustrated with finely executed engravings.

*The American Agriculturist* is a monthly periodical of thirty-two pages, devoted to the subject of agriculture. Mr. Orange Judd, its publisher, is spoken of as a gentleman with whom it is safe to deal; and as he gives more matter, and that more interesting, and at a cheaper rate, than any other serial of its class, the public will find it to their interest to send \$1 to his address, 189 Water street, New York, and receive its monthly visits for a year. Its perusal takes us back to those youthful days when, on our father's farm, before the cares of business had come over the vision of our dreams, "we whistled as we went," in the full enjoyment of nature's beauties.

WE are in the receipt of the *Architects' and Mechanics' Journal*, the first number of which for October has just made its appearance, and is, as its name indicates, a mechanical publication, worthy of attention. It is published monthly at 128 Fulton street, New York, at \$3 a year. The number before us is promising of usefulness, and we shall be glad to see it successful. Such a publication supplies a place sometime vacant in this country.

In addition to the above, October has presented us with another mechanical publication, the *Practical Machinist*, "devoted to the encouragement of inventive genius and mechanical skill." No. 1, Vol. I. bears date October 12, and is designed to be a weekly publication, at the low price of \$1 a year. Published by T. H. Leavitt & Co. 37 Park Row, New York.

The editor requests "our brethren of the Press" to "criticise us kindly; commend and encourage us, if you can, honestly; but don't flatter us unduly, nor consider us beneath your notice." Well! Mr. Machinist, we must acknowledge that your modesty is commendable, and your appearance and dress "first rate;" but we think your pages too large for a work intended for binding and the library. These, however, are of minor importance to having your pages well filled, which, as the initial number indicates, will be done. We hope this new candidate for public favor will meet with success.

## EDITORIAL CHIPS AND SHAVINGS.

TO THE PUBLIC.—We are credibly informed, that in a few instances where the back numbers of this Magazine have been ordered from abroad, of dealers in New York, in order to serve their own selfish purposes and save a little trouble, some have written back that they cannot be furnished by us. This is not so. Any back numbers can be had from the commencement; and we would thank any who have been thus trifled with, to send their orders directly to this office, stating the name of such dealers, that we may apply the proper remedy. NOTE: We do not hold ourselves responsible for the actions of any persons calling themselves our agents who are not able to produce a *genuine* authority from us, over our signature, and can give a printed receipt from us to which our engraved signature is attached. \$25 reward will be paid to any one prosecuting to conviction, any unprincipled impostor that may attempt to impose themselves on the craft hereafter, as *our* Agent.

THE TURN-OUT OF A FAST YOUNG MAN UNDER THE HAMMER.—On the 4th of October the effects of W. J. Lane, Jr., were sold at auction under the direction of the President of the Fulton Bank, the property of which he had abstracted. The following articles were sold at "ruinous sacrifices" as the figures show:

1 Wooden side-bar wagon	sold for	\$80 00
1 Elliptic spring	"	117 00
1 Top wagon	"	217 50
1 Caleche	"	330 00
1 Single-horse sleigh	"	85 00
1 Double " "	"	162 50

The horses were next trotted out, and the excitement among the sporting gentlemen, who were present in large numbers, waxed great. First, the roan horse "Cobb" was brought forward into the centre of the stable in the midst of a great crowd. Persons outside called to the auctioneer to trot him out of doors, so that they could have a look at him, but that functionary declined, remarking that the horses had all been on exhibition at the stable for a week, and bidders would have only themselves to blame if they did not know what they were buying. "Now, gentlemen, understand once for all," said he, "this is an assignee's sale, and we warrant nothing; how much shall I hear to start him?" "Open his mouth, and let us see how old he is," said one. Some one said the horse cost \$650. "Yes, other people's money," was the rejoinder; "that's no criterion." The bidding commenced at \$100, and run up slowly from two to five dollars a bid, until it reached \$282.50, at which price the horse was "knocked down" to Mr. George Brown. "Cobb" was understood to be twelve years old, and formerly quite a celebrated roadster. He had been out at pasture two or three months, and was a little lame; nevertheless he was considered a fair bargain. The dark bay horse "Boston" was then produced—a

very handsome animal, about nine years old, said to go in 3:10, and to have cost \$1200. Somebody promptly started him at \$500, and after coaxing a long time for another bid Mr. Andrew Stevens offered \$550, and became the owner of the animal.

The sorrel horse "Selim" was next on the catalogue. He is a splendid specimen of the equine quadruped, having cost young Lane or somebody else \$1100, and going inside of 2:40. The starting point was \$400, and the bids came thick and fast till the maximum of \$500 was reached, at which figure Mr. Henry Elder became the happy owner.

The fourth and last on the list was the chestnut mare "Bess," alleged to be half-sister to "Selim," seven years old, and the fastest horse in the lot. To start the ball \$400 was bid. "Whew!" exclaimed a gentleman said to be connected with the Fulton Bank, "she cost a thousand dollars." "Well, no matter," replied the bidder, "the Fulton Bank can stand it." "That is so," rejoined the officer. The bidding went on in the most animating manner, and the sleek, well-kept little beast finally came into possession of Mr. Robert Macair, at \$535. We were afterwards informed that she cost young Lane \$700, and can go her mile in 2:37.

THAT PERCH-COUPLING NON-SUITED.—Among the cases lately brought before the United States Court, at Hartford, Ct., was that of Hansknecht against Messrs. Wood Brothers, of Bridgeport, for an alleged infringement of his perch-coupling, patented in 1852, and re-issued in 1857. These patents so claimed, consisted in placing the turning point of the front axle some distance back of it, so as to cause a vehicle to turn in a smaller compass.

The Messrs. Wood Brothers claimed that the assumed invention was not new, that the same thing has been in use since 1843.

The case was called on, but the plaintiff did not appear, and consequently was *non-suited*, leaving him to pay the costs. This looks *very much* as though the patentee has abandoned his claim to a prior invention. In connection with these facts it is complained of by other parties sued, that they can never get their cases to a trial. We believe such is the case in this city where the leading coach-makers have combined in their own defense. The *only* triumph gained for this patent, we understand, was a temporary injunction against a firm in New Orleans, which, though at the time highly boasted of, has for some time been removed.

QUEEN ELIZABETH'S PRESENT OF A COACH IN 1582.—Elizabeth's ambassador writes to her: "The French King hath commanded to be made for your Majesty an exceeding marvellous princely coach, and to be provided four of the fairest moiles which are to be had, for to carry your Highness's litter. The King hath been moved to shew himself in this sort, grateful to your Majesty on the receiving those dogs and other singularities you were lately pleased to send unto him for his falconer."—*Strype's Annals*, vol. 3, p. 78, 2d edition.

NOT FOUND OUT YET.—On the 30th of August, 1758, a remarkable carriage set out from Aldersgate street, Birmingham, England, without using coomb or any oily or liquid matter to the wheels or axles. The inventor had engraved on the boxes "Friction Annihilated," and it is assured that the carriage will go as long and as easily, if not longer and casier, without greasing, than any ordinary stage carriage will do with greasing. If this answers, it is perhaps the most useful invention in mechanics that this age has produced.—*Southey's Commonplace Book.*

THE HACKMEN.—This class of persons has in all countries been charged with every class of trickery to earn a fare; but the jarvies of San Francisco have resorted to a mode of "forcing the season" that is a little ahead of all others. Standing at the door of a concert-hall as the company emerges, one is seen with an out-spread umbrella, upon which a brother hackman is pouring water, to convey the idea that it is raining.

THE ST. LOUIS, MO., FAIR.—We learn from a reliable source, that Mr. Theodore Sloan of St. Louis, had on exhibition at this fair a fine collection of heavy pleasure carriages. Among the lighter carriages were some fine ones from the manufactory of Messrs. Fallon & Wright, the buggies particularly so. To the above we may add that Smith & Bro. exhibited some good specimens of light hubs, spokes and rims, the spokes produced from the Blanchard lathe.

HEARSE.—We have been kindly furnished with drawings of the Hearse built by Messrs. Kingsbury & Whitehead, of Albany, lately exhibited at the State Agricultural Fair in that city, which we intend to present to our readers in the number of this Magazine for December.

#### A NEW AERIAL CHARIOT.

A NEW candidate for public wonder has appeared in England in the person of Viscount Carlingford, who has constructed a machine for flying, "like an eagle in the air." The form of this machine, or chariot, as the inventor terms it, is something in the shape of a boat, extremely light, with one wheel in front and two behind, having two wings, slightly concave, fixed to its sides, and sustained by laths of half-hollow form, pressing against them, and communicating their pressure through the body of the chariot, from one wing to the other, and supported by cords, whose force acting on two hoops nearly of an oval shape, hold the wings firmly in their position, using a force that cannot be less than 10 tons, on the principle of a corded musical instrument. The chariot is provided with a tail that can be raised or lowered at pleasure, and which serves for giving an elevating or declining position, and worked by a cord that communicates into the interior of the chariot, which is drawn forward by an aerial screw of peculiar construction. The wings of the chariot are covered with a network of a lengthened square shape, which produces the effect of birds' feathers when the machine floats on the air, covered with silk, at which time may be seen its progression with the points forward and the same backwards, by which no pocket, as it were, can be formed by the pressure of the silk on the air.—*Philadelphia N. A. Gazette.*

#### INVENTIONS APPERTAINING TO COACH-MAKING AT HOME AND ABROAD.

##### AMERICAN PATENTED INVENTIONS.

SEPT. 6.—IMPROVED MACHINE FOR BENDING WAGON TIRES.—Wm. Mosher and Isaac H. Mosher, of Greene, N. Y.: We claim the clutch or clasp to hold the end of the bar, in combination with the former being made three fourths of the circle, and the arrangement of the lever for operating, as specified and for the purposes set forth.

IMPROVEMENT IN BITS FOR CUTTING WASHERS.—Henry Bennie, of Buffalo, N. Y.: I claim, first, the arrangement of the cutters, D and D, upon the ends of the sliding bars, C and C, and at right angles thereto; the said sliding bars passing through a mortise in the shank, A, and lying parallel with each other, and one above the other, so that the cutters will work upon the same side of the centre joint B, substantially as described.

Second, I claim the recess G, made in the lower end of the shank, A, so as to allow the inner cutter to slide close up to the point, B, and thereby adapt the instrument to cutting very small washers, as set forth.

[This instrument was illustrated on page 72 of the September number of this Magazine. The engraving having attracted the attention of our correspondent Mr. E. Briggs, of Medina, Ohio, he writes us, that, "Noticing in the Magazine a drawing of a machine for cutting washers, I send you a drawing of mine which I have got up for the same purpose, and meant to have sent to you before for the benefit of the craft, although I had no idea of applying for a patent on it; I send it, as I think it an improvement, as my knives slide one against the other and the thumb screw acts more directly on both at once. It may be original with him as it was with me. I know he never saw or heard of mine, nor I of his until I saw it in the Magazine. I made mine about two months ago." The drawing we omit, but a sketch may be seen at this office.—ED.]

SEPT. 27.—IMPROVEMENT IN HORSE HARNESSSES.—John Rouse, of Port Gibson, N. Y.: I claim the double-eyed hook, D, arranged and described in the yoke ring, C, so as not to be withdrawn therefrom, in combination with said ring, and with the divided hame straps, E E', which are respectively secured to the opposite eyes of the hook, for the purposes specified.

OCT. 11.—AN IMPROVED OMNIBUS REGISTER.—W. M. Keague, of Brooklyn, N. Y.: I claim, first, the arrangement and combination of the platform, D, vibrating-lever, C, and adjustable spring, G, substantially as and for the purpose specified.

Second, In combination with the platform, D, and spring, G, I claim the sliding-bar, H, spring-catch, N, and wheel, K, substantially as and for the purpose described.

Third, arranging the step, A, in combination with the registering apparatus, substantially as described, so that it registers half-fares as well as full fares.

##### RECENT EUROPEAN PATENTED INVENTIONS.

JUNE 21.—Improvements in India-Rubber Shackles, and in Springs for Carriages, and the Metal Fittings connected therewith—William C. Fuller, 2 Bucklesbury, Cheapside.

JULY 6.—Improvements in the Manufacture of Cast Steel Tires—Sampson Lloyd, Wednesbury, Staffordshire.

JULY 19.—A New System of Eccentric Socket adapted to Axle-Trees—Jose Luis, 1 B Welbeck street, Cavendish Square.

AUGUST 2.—Improvements in Wheels for Railway and other Carriages—James C. Ashwell, Dorchester street, New North Road.

AUGUST 6.—Improvements in Lubricating the Axles or Journals of Wheels; also applicable to Lubricating Apparatus for the Transmission of Motion in General—Albert F. Delannoy, Paris.

For the New York Coach-maker's Magazine.

**C. J. L. MEYER'S EXPANDING, SELF-CENTRING HOLLOW AUGER, OR TENONING MACHINE.**

PATENTED, MARCH 29, 1859.

FIG. 1 is a perspective view of the implement. A is a bit, stock, or brace, made expressly for this tool. B is the hollow cylinder of the cutting tool. E E and G G, are sections that slide in the grooved head of the cylinder or stock, B; these sections can be seen separately in the

hollow auger larger inside, and the auger smaller outside, so that they cease to correspond together with that accuracy so necessary to make a perfect wheel. It is also often desirable to make the tenon of a size that is not generally provided for by the present hollow augers, as for example the nine-sixteenth, eleven-sixteenth, thirteen-sixteenth, and fifteen-sixteenth of an inch. All these difficulties are entirely overcome by the Expanding, Self-Centring, Hollow Auger, which can be adjusted in a moment so as to make a perfect fit to any bit. It works smoother and easier than the common tool; for the tenon, being only held by four lines, instead of all around, the friction of the tool is reduced very much, while the tenon is held sufficiently firm for all purposes.

Every mechanic will see, at once, that this is an entirely indispensable instrument; that it is, without doubt, the most perfect contrivance ever designed for the purpose of cutting round tenons, &c.; and that it will be universally adopted, and, consequently, drive all other tools of this kind out of use. These tools are finished in a neat, workmanlike manner, and are warranted to be perfect in every particular. The present size of hollow augers will make tenons from one-half to one inch, and any size between them. Extra sizes will be made to order.

PRICES.—For Implement, without Brace, to be used in a common Brace, \$7; for Implement, with brace and an extra set of Knives, all put up in a neat black walnut case, with lock and key, \$8; for a larger Implement, without Brace, to be put on a Mandrel and used by power, \$15. These prices cover the right of use.

C. J. L. MEYER, Patentee and Manufacturer, No. 230 Market street, Newark, N. J.

This Auger is on exhibition at the "Inventors' Exchange" of S. A. HEATH & Co., 37 Park Row, N. Y.

All letters of inquiry should inclose a three-cent postage stamp.

RAILWAYS IN EGYPT.—Egypt now possesses the following lines: Alexandria to Cairo, 131 miles; to Marionth, 17; to Meks, 6; to Rassateen, 3; from Tanta to Lamanuel there is a railway for 21 miles; from Cairo to Suez, 91; to Barragel, 15; to Beni Lueff, 76—in all 360<sup>2</sup> miles. Besides these there are smaller branches, from Cairo to the Citadel and Kasrnn; from Lamanuel to Mansoura and Damietta, from Damanbrou to Afte, which last extends to Rosetta. The mileage of these minor lines is not accurately known. The bridge of Kasr Zayat across the Nile, which will not be completed before next June, promises to be a splendid work. When the railway system is properly developed, our government will save £20,000 per annum in the expense of forwarding the Indian mail.—*P. M. Mag.*

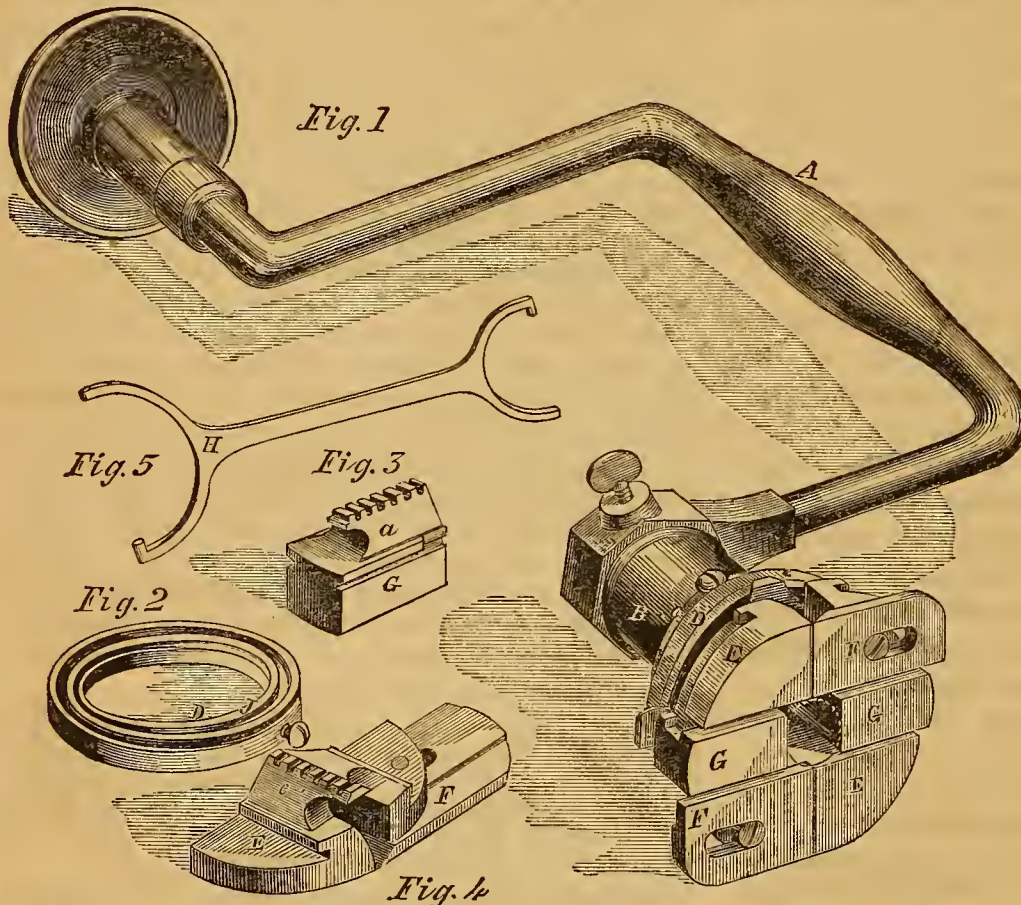

figures 3 and 4. D is a ring that has a thread or worm cut inside, so that it fits into notches on the lower end of the sections. This ring can be seen separately in fig. 2. C is a ring behind D, to secure the latter to its proper position on the cylinder, B. F F are the knives or cutters, fastened on the sections, E E. H. Fig. 5, is a key or wrench for turning the rings C and D; turning the ring D will cause the sections to expand or contract concentrically. The teeth of the sections and the thread of the ring, D, are made in such a way that the tool can be tightened by ring C, in case of wear, so as not to become loose. This view shows the Auger partly expanded. The tool is made of the best malleable iron and cast steel, and all the wearing parts are case-hardened.

In offering this implement to the mechanic, the inventor is confident of supplying a want that has been, for a long time, most seriously felt by all mechanics who are using such tools. Every wheelwright, for example, is aware of the trouble attending the use of the common hollow auger for tenoning spokes. It is not always that the hollow auger for boring the tenon, and the auger for boring the hole, fit together as perfectly as desirable; even if they do so at first, the wear in using them will soon make the

SPECIMEN cuts for charts in our next number.



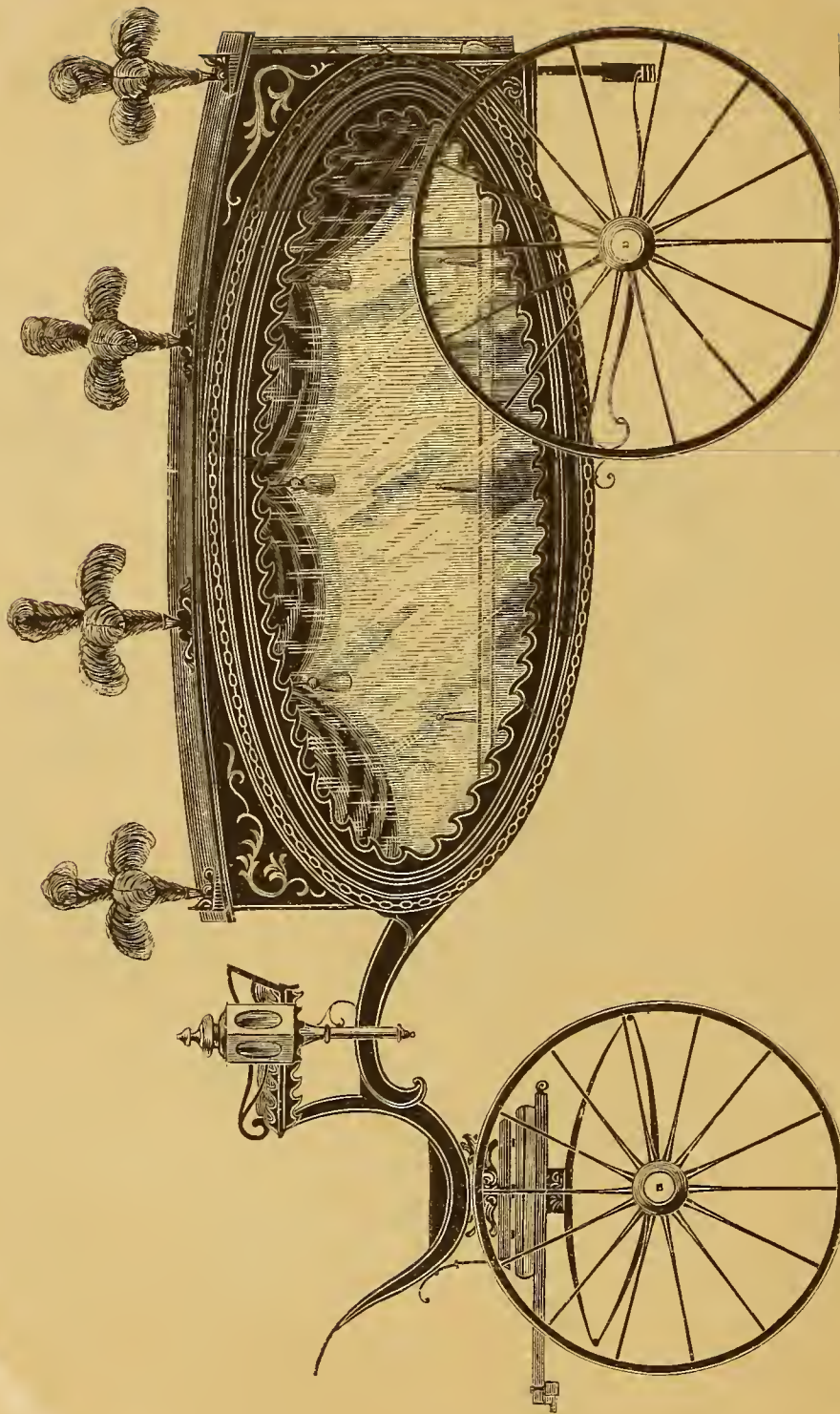

MESSRS. KINGSBURY & WHITEHEAD'S HEARSE.— $\frac{1}{2}$  IN. SCALE.  
*Engraved expressly for the New York Coach-Maker's Magazine.—Explained on page 132.*





BACK VIEW OF THE HEARSE ON  
PLATE 22.— $\frac{1}{2}$  IN. SCALE.

*Engraved expressly for the New York Coach-Maker's Magazine.  
Explained on page 132.*



17  
18

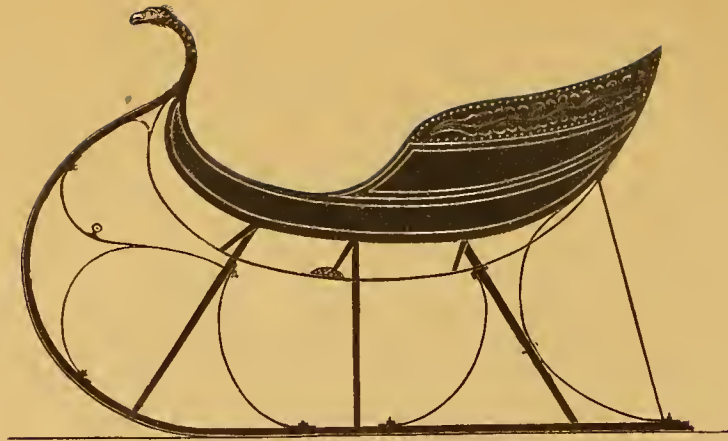

CUTTER SLEIGH.— $\frac{1}{2}$  IN. SCALE.

*Engraved expressly for the New York Coach-Maker's Magazine.—Explained on page 132.*

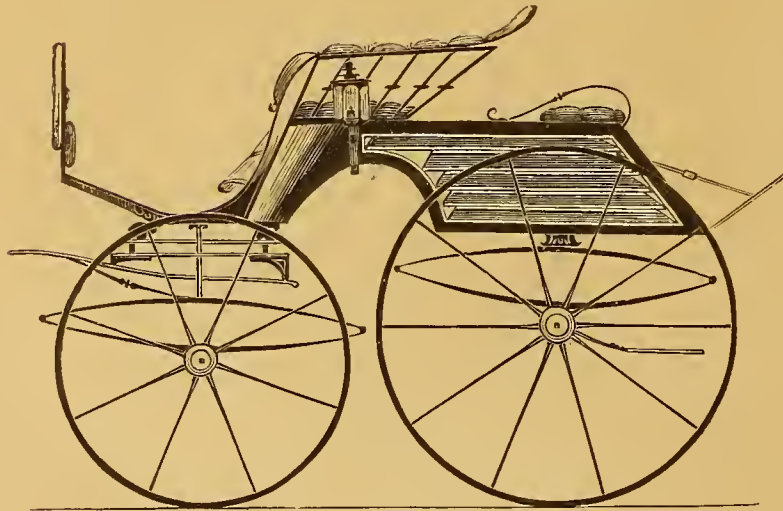

DOG-CART PHAETON.— $\frac{1}{2}$  IN. SCALE.

*Engraved expressly for the New York Coach-Maker's Magazine.—Explained on page 132.*



DEVOTED TO THE LITERARY, SOCIAL, AND MECHANICAL INTERESTS OF THE CRAFT.

Vol. II.

NEW YORK, DECEMBER, 1859.

No. 7.

## Miscellaneous Literature.

For the New York Conch-maker's Magazine.

### THE AUTOBIOGRAPHY OF CALEB SNUG, OF SNUGTOWN, CARRIAGE-MAKER.

#### CHAPTER V.

The new journeyman from New York—His eccentricities supply fun for the shop—Mrs. Flatt's hostility for the stuck-up jour., and his scheme for getting his name up—The soaked multiplication table—Mrs. Flatt's reputation as a nurse, and skill in darning stockings—Reflections—A childish letter from a brother at home.

MR. FLATT was accustomed almost weekly to visit New York, with the productions of the firm's establishment, for Mr. Stillwagon, one of the earliest personages to establish a repository in that celebrated "town." On his return home from one of these visits, he brought with him a new journeyman, who had been very highly recommended to our boss by "the repository man," as a finished workman. As Mr. Stillwagon had entered into an agreement to take all the wagons and carriages the Snugtown firm could manufacture, it was supposed that the interests of all parties would be promoted by hiring a man "from York," that was able to instruct the greenhorns of a country establishment. At any rate, our "old boss" felt that he had secured the right man for his shop, and "the boys" came to the conclusion that they would not be necessitated to go to France to perfect themselves in the art, mystery, trade, and occupation of carriage-making, when they had the *ne plus ultra* in their very midst. Matters went on very smoothly for a few days, but it was soon evident that Mr. Tires, the jour. from York, had so much eccentricity compounded in his character, as to render him more a subject of ridicule than of much respect. To all these traits was added a strong feeling of self-importance, which looked down on us with scorn. His demeanor, perhaps, might pass in a crowded city without attracting much attention, but in our little village, where simplicity was the predominant character, his important bearing soon made him the cynosure of all eyes. There was no disputing the fact that Mr. Tires was a fast workman, but that he was a *good* one, was not quite so apparent. He was very boastful of his having been born and nursed in the lap of luxury, in Jamaica, one of the West India Islands. In describing the home of his

youth, he, with a pomposity truly ridiculous, said: "You go up a broad street, then turn up a long lane lined with fine cocoa-nut trees on each side, there you will find a large and splendid house—there my mother lives: she has more than a hundred niggers riding on mules." This description was followed by such a scene of mock astonishment, and outbursts of laughter as convulsed the whole shop. Some wondered what could have induced him to leave such a state of comparative ease for a life of toil at carriage-making. Others advised him at once to go home to his mother; it would be the best thing he could do; but amid it all he preserved a countenance that would not have discredited a stoic. The combination of nonchalance, and airs of importance exhibited on this occasion, proved a godsend to us, and as in almost every shop there will be found some individual to take the lead in mischief and fun, so in ours, his expressions were so often repeated as to become "household words" in the shop for a long time.

Our new journeyman *was* a great personage in some respects. He could "dress-up" a set of sawed-by-hand short felloes in forty minutes, or saw out the "stuff" and build a paneled gig-body in three days, easily, and do many other jobs at carriage-work equally expeditiously; yet, however well he may have pleased Mr. Flatt, as for the mistress of Flatt's Hall, she entertained and nursed a serious hatred toward him, although not a boarder of hers, and told me I "must not heat his glue-kettle, nor wait upon him at all." To this injunction, however, very little regard was paid, as I never would acknowledge "petticoat government," and had besides, under all circumstances, endeavored to so manage matters as to always have *my* bread fall, buttered side up. I would here just remark, *en passant*, that if any young apprentice wishes to get along "smoothly and pleasantly," he will always find it the wisest policy to be accommodating, and *never refuse to turn the grindstone!* The reason she gave for her conduct, she said, was, "she could not bear to see such stuck-up fellows as Mr. Tires, and she would not wait on them, she knew." I promised myself, in a *sotto voce*, to carry out her instructions at—a proper time.

Our new shopmate seems to have relied entirely on his *otium cum dignitate*, and cared very little for Mistress Flatt, or her master "Old Sam." He was bent on "cutting a swell," and whether his object was to "appear somebody" to the male portion of the inhabitants of Sawgetup, or

that he expected to impress the "calico"—silk-worms were scarce in those days—with the idea that he was some "high-born," and thereby "catch an heiress," the fact was evident, that he was "bound to blaze." With this notion matured in his brain, he ordered from the only livery-stable in the village, a light wagon—there were no *light* buggies then—before which he ordered two horses harnessed "à la tandem." These he drove across and re-cross the long bridge which spanned the Sawgetup river, on both sides of which the village was situated. Was his intention to get his name up, it proved a signal failure in this instance, for his procedure disgusted the sensible inhabitants of that unostentatious community, both male and female, and brought down upon his shallow head the decided scorn of all. The result was, our "West Indian" found Sawgetup an "unhealthy" place for him. With the utmost possible dispatch he decamped the second day thereafter, and with him all our dreams of fun!

Mr. Flatt had always held the opinion that in order to do business, it was necessary to commit to memory the multiplication table. This was about the first question put to a "new comer:" "Do you know your multiplication table?" This, the reader will have learned, was answered by implication, for me, by Mrs. Snug, so that I was saved this infliction; but "boss Flatt" had just about this time taken an illiterate young man to learn the blacksmithing department of the craft, whose ignorance was a little too much for even him, who declared that he "did not think any one would become the better workman for understanding Latiu." Well, Ananias (that was his name), who was more inclined to practising mischief than to studying any multiplication table, was set to learn how much five times seven were, &c., but the "thing" was so hard to commit to memory, that in order to soften his labor, he put it over night into Mrs. Flatt's porridge-pot of pork-grease, standing in the chimney corner, as he said, "to make it go down easy." This greatly enraged the "old mistress," but, *nobody knew how it came there!* By some misfortune, under such circumstances, every apprentice was wonderfully "obfuscated" when *she* instituted inquiries of this nature. By this means, the boy finished *his* schooling in the multiplication table, Mr. Flatt giving him over as being "a hard case."

With her many failings—and who has not some?—yet Mrs. Flatt had two redeeming points, at least, in her character. She was very attentive to any member of her household were they unfortunately visited with sickness, and I am charitably disposed to believe that her conduct on such occasions was prompted by none other than pure motives, although some did attribute it to self-interest. Another commendable trait in her was—so my mother, who was well qualified to judge, used to say—*she always kept my stockings well darned.* I very much fear I could not with truth say as much in favor of some more modern coach-makers' wives of my acquaintance!

The first year of my apprenticeship had now passed away, the earlier part of which—incredible as it may appear when the reader is told that my parents lived within the distance of two miles from Sawgetup—I had suffered much from home-sickness, when the remembrance of the scenes of my youth came up in my mind, for

"Be it ever so humble, there is no place like home."

Now I found a degree of consolation in the circumstance that I had *only* four years more to *enjoy the privilege of*

having "hard work" to perform and "hard fare" to subsist upon, before I should become my own master, and then, should I think proper, the Snugtown folks might read over the door of a large "three-story" at the corner of Windup and ——— streets,

CALEB SNUG, CARRIAGE MAKER.

The fact was, I had so far become weaned from home, that by the intervention of a stormy Sunday I *was enabled* to stay away from Snugtown *almost* two weeks, when, from the hands of an old friend of our family, I received the following characteristic letter:

"SNUGTOWN, May 13, 18—.

"DEAR BROTHER CALEB:

"It is now about one year since you left us to learn your trade. This seems a long period to me. But during all that time, mother says, she has always had you with us on Sundays; but now you have been away almost two weeks. She feels very bad on this account, and says she is almost sorry she let you go away from home to learn a trade, she is so afraid you will be led away by bad company. Fanny says she don't know but mother will go crazy if you don't come home pretty soon. I think, and so does Patience, that you had better come right away, not only to satisfy mother, but to look after Jane Collins; for Sam Willis says he means to cut you out. I told Jane what he said, but she declares she would not have Sam with his 'red brick top,' even should 'uncle Eph' throw in a wagon-load of gold dust with him. She says she has owed him a grudge ever since he pushed her into the water at Muddybrook, when he went home with her last winter from Aunt Molly's quilting party. Father, too, says he was very thoughtless, or else he would never have consented to let you have gone to Sawgetup when he needed you so much on the farm. Pat O'Donohoe, the green Irishman he hired this spring to work on the farm, is so dumb, father (you know how easy he is) says he wishes the bog-trotter was back in Ireland; he is so stupid. Father sent him into the cellar the other day to draw some cider, and he says he thinks Pat must have left the tap out of a newly-tapped barrel full, for it is nearly all gone! Between you and me, I believe Pat has put it down his throat, for he has looked for more than two weeks as though he was more drunk than stupid. Fan says she intends to make you one of the neatest and prettiest bosomed shirts ever seen in Sawgetup, for your next New Year's present. She wishes it kept a secret from you; so keep dark and be sure and come home as soon as possible. Love from the whole family, especially from

"Your affectionate brother,

"CORNELIUS SNUG."

I have said that I was enabled to stay away from home *almost* two weeks; yet they were the longest weeks I had ever seen. The reader who has never been obliged to separate himself from the endearments of a good home, to obtain a trade, may be inclined to smile at the simplicity of the above letter and its attendant circumstances, but are there not many hearts that have tasted of this worst of sicknesses, home sickness? I know from experience that the pleasures of childhood are so deeply fixed in the heart, that though other associations may bring their enjoyments, these can never be eradicated therefrom. Such was my condition, and my brother's letter was well calculated to draw me homeward at the first opportunity.

For the New York Coach-maker's Magazine.  
**GEOMETRY OF CARRIAGE ARCHITECTURE.**

BY A PRACTICAL COACH-MAKER.

**PART NINTH—BODY CONSTRUCTION.**

ON plate 14, vol. I., will be found the body, which is here represented in frame, all ready for paneling. We have substituted the heel-bracket A instead of the stay irons for the front seats, which would suit some parties best. The principal feature in this job is the round corner B, which we make out of a nice tender piece of ash, well seasoned. It will require to be in size about three by nine inches, with a double tenon on the bottom. On the top, the front and side-rails are framed in, as seen in the diagram. After the corners are rounded, you have to fit in a piece of white wood, C, with which to form the rounding at the base. The back quarter-light is represented stationary, which is generally done now. The frame can be made of cherry or white wood, about an inch thick, halved together, and rabbeted on the inside for the glass. This frame must be rabbeted into the standing pillar and top-rail, and serewed into the arm. The seroll work on the top of the shutters can be sawed out of a piece of cherry, the full width of the top, and serewed on. The most proper place for splicing the bottom-side and rocker, is at the doorway. The splice in the bottom-side should be so as to take one of the step bolts through the centre. The foot board bracket may be secured by tenons and screws. The body-rocker is intended to run out at the coneave D, inside of which the front should be well serewed on. The front quarter panel should extend to the front of the heel bracket A. This body could be built with a swelled back very easily above the rail, or with a swelled front if desirable.

For the New York Coach-maker's Magazine.  
**BILL HAWKINS AND THE DANDY.**

BY JAMES SCOTT.

To hear old Bill Hawkins tell one of his droll stories, was a rich treat to those who could appreciate the inexhaustible vein of quaint, dry humor that pervaded all he said. The following reminiscence of his courting days, although lacking much of the force that Billy's manner of recital lent it, may serve to raise a smile on some careworn cheek.

'Squire Collier's three daughters were the politest girls in the village of Bruntwood, a fact which the young ladies themselves knew but too well, as was evinced by the high-

falutin airs they assumed. But then, to do them justice, they couldn't well be ignorant as to their personal attractiveness, when they were constantly besieged by a score or so of sighing, ogling, whimpering, and finger-squeezing "lovers." How I, who knew the sisters so well, was ever drawn into the unmitigated madness of loving Kate Collier, has always exceeded my comprehension. I knew her for the heartless flirt that she really was, and yet, a kind

THE GALASH COACH ON PLATE 14, VOL. I, IN FRAME READY FOR PANELING—THE DIFFICULT POINTS OF CONSTRUCTION EXPLAINED.

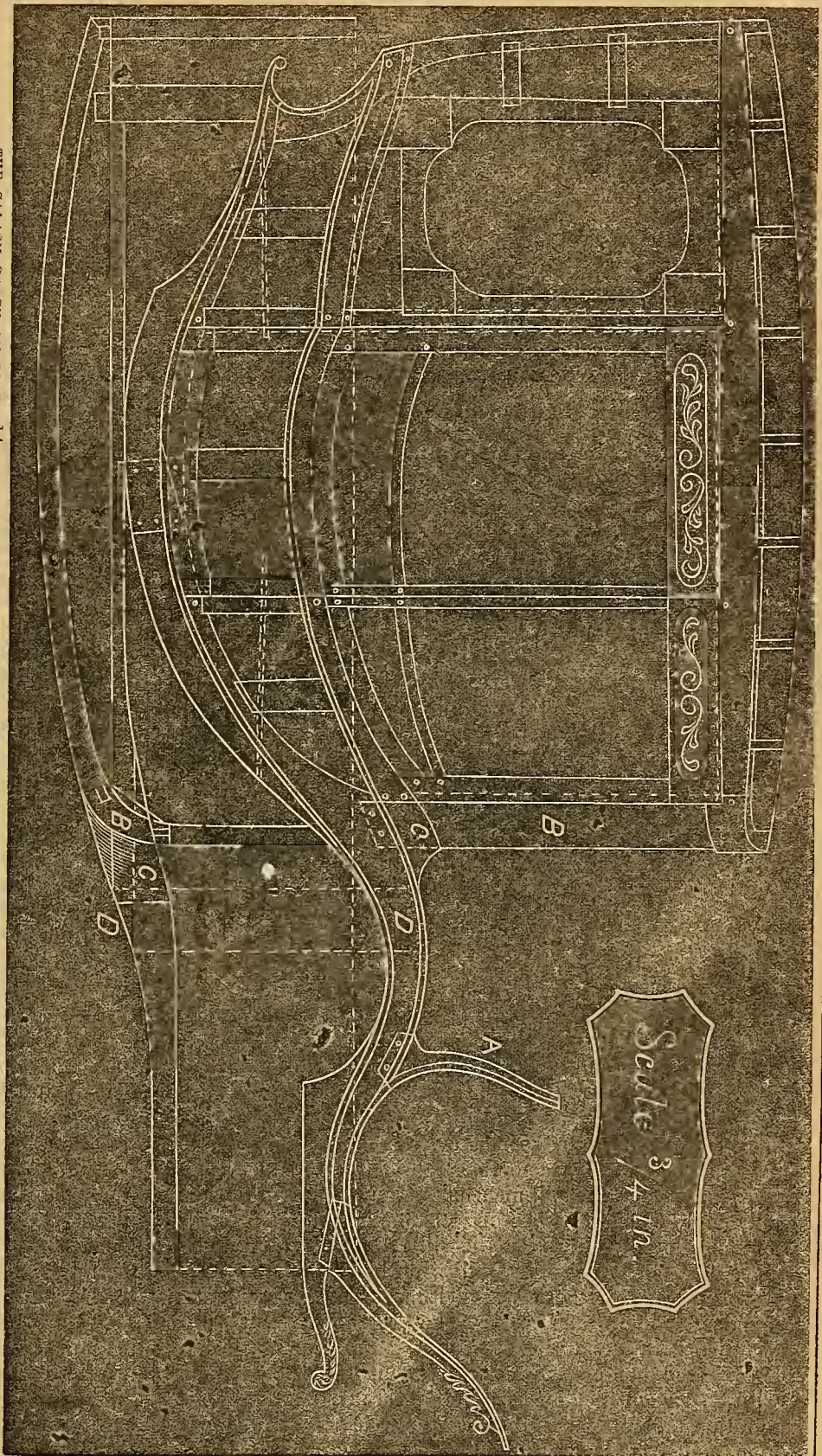

word or two, and one of those killing smiles she used as bait, did my business. I took to star-gazing, moonlight walks, and starving my rather corpulent frame into sentimental proportions on a homœopathic diet of corn-dodgers and sour-kROUT. Hair and poetry became my passions, and I cultivated moustaches, and spouted Byron with such frantic energy, as to endanger my windpipe, and fill the minds of my landlady and fellow-boarders with horror and disgust.

Kate, who was the youngest, and perhaps the prettiest of the three, possessed, in a marvelous degree, the power of fascinating all on whom she tried her bewitching faculties; it was not strange, then, that the feeble attempts I at first made to extricate myself from her toils, were abortive; reason fled before her smile, and the soft music of her voice set folly to dancing jigs in my poor deluded brain. In my blindness I believed that the deceitful little jade loved me; so I was the happiest fellow on earth, and as proud of my conquest as a yellow dog with four tails. The style I put on among my chop-fallen rivals when we met at the 'Squire's was far from conciliating, and the consequence was they hated me cordially. Strenuous efforts were put forth to supplant me; lies were told to my disparagement, and threats the most dire were showered on my devoted head. Violent hands were even laid on me by one infuriated individual, who declared that nothing short of the demolition of my countenance would satisfy his wrath; but in the midst of the operation he became so exhausted, that it was found necessary to carry him home on a board. His fate acted as a cooler on the others, and for the time, I was left to bask in the smiles of the divine Kate, in peace—peace! alas it was of short duration.

It was a cool, pleasant evening in September, and from every window in the Collier Mansion lights flashed out into the darkness, throwing fantastic patches of gold across the dusty road, and up into the tall poplars, that, like a phalanx of dusky giants, guarded the building from the vagrant whims of sun, wind, and rain.

Crowds of the village belles and beaux, gaily attired in their Sunday dry-goods, were passing in panoramic succession through the wide front door, flashing along the hall, and adding new effulgence to the glory of the newly papered and white-washed parlors. It was Kate's—my Kate's—birth-night, and the élite and fashion of Bruntwood were congregating, by special invitation, to honor the festive occasion. The assemblage was large—the rooms were ample in their dimensions—the old 'Squire had a jolly smile or hearty word of welcome for all, and to the male portion of the visitors he slyly revealed the hiding-place of a portly jug of old, oily Bourbon—this was twenty years ago, and there was neither a Maine-law nor a popular antipathy against whiskey, as now. The three beauties were radiant in silks, smiles, and curls. Everybody jested, laughed, flirted, and “went in” for enjoyment with an *abandon* seldom seen in the stiff-necked mutual-admiration affairs called parties nowadays. Kate was kind, and I was luxuriating in a perfect paradise of love-kindled joy. As for my rivals, they were endeavoring to hide their chagrin in indiscriminate and rather noisy flirtations with the unmarried femininity present. In short, every thing seemed to indicate that the party would be a complete success; and it doubtless would have been so, but that his Satanic majesty, or some of his most enterprising agents, with diabolical malice introduced an element of discord in the shape of a tall, lean, tallow-faced stranger,

who being on a visit to the Gilpin family, accompanied said Gilpins to the festivity, and was presented as: “Our particular friend from the city, Mr. Curltop.” I have seen dandies in great variety, as to shape, style, and the material employed in getting the thing up, but Curltop eclipsed any specimen that had ever come under my optical observation. He was, to use a modern phrase, “decidedly loud.” Broadcloth, linen, watch-chain, patent leather, and perfumed hair, were piled on with costly profusion, and the smirking, brassy countenance said, as plainly as if labeled: “Look at me, O verdant villagers! an't I pumpkins on a gate-post?” At the first glance, I conceived for this hybrid conglomeration of nature and art, a deadly antipathy, and an inward conviction that there would be war between us, tingled with electric force to my very finger-ends. The supercilious elevation of nose, and dainty nicety of step, that marked his advance to the centre of the room, and special introduction to Kate and her sisters, added fuel to the flame of hatred that already burned within me, and when he was received by them with the warmest expressions of regard—Kate's the warmest of all—I longed in my jealous rage to clutch him by the throat and shake him out of his ten-dollar boots. I have intimated that my feelings towards the animal were of a hostile nature, but how shall I describe the raging conflagration of vindictiveness that consumed me, when the object of my heart's adoration—my Kate—took his arm, and without saying, “By your leave,” left me to my “pheelincks,” while she sailed off to parade the animated superstructure of cloth, leather, and fancy goods on an introductory tour around the apartments. I have already piled up the agony so high in describing the awful nature of my sensations, that I must leave you to imagine the additional pressure they received, when I discovered the eyes of my rivals fixed upon me, and fairly blazing with malignant satisfaction. The very first hiss of a laugh, or the first syllable of a mocking word from one of them, would have produced an explosion; but they forbore, and by a superhuman effort, I assumed the outward semblance of composure, and mingled in the throng of guests.

Half an hour passed, and during that brief period my feelings underwent a radical change. The strange phenomenon of love suddenly turned to hate, was being worked out within me; revenge now sat perched on the deserted pedestal of affection, ruminating with tiger-like cunning and ferocity on the best means of annihilating its victims; who, as if to hurry the consummation of their impending doom, were billing and cooing most lovingly in a retired corner. Avalanches of fire surged through my veins at the sight, and, fearful of some premature exhibition of feeling on my part that would mar my plans for retaliation, I slipped out of the room and into the garden unperceived. For a while I trod the graveled walk in a state of mind bordering on distraction, but the cool, bracing night air calmed my excited nerves, and I was about to re-enter the house, when a male and female voice, singing a duet, with piano accompaniment, arrested my steps. The female voice was Kate's, and by a peculiar lisp, I recognized in the other that of Curltop. Prompted by motives of pure mischief, I left the path, and entering a tomato patch, stealthily approached an open window that brought me within ten feet of the singers. The grotesque contortions of the dandy's face, as he sang, nearly betrayed me into laughing outright, but hate drove back the impulse, and I clutched my hands together in fury; as I did so, I found a round, soft substance



in my grasp, which, on examination, I found to be a large, ripe *tomato*, but as I was even then crouching in a patch of those useful vegetables, there was nothing surprising in the incident; that I retained it in my hand instead of throwing it away, was, under the circumstances, rather strange; it was, in fact, the work of the same demon that introduced the obnoxious Curltop, to blight my first dream of love, and drive me mad. The singing went on, and each succeeding verse drew marks of applause from the audience. I knew the song well, and they were about to finish—the last notes of the interlude were thumped out—Curltop's mouth opened to the dimensions of a fair-sized cellar-door, and sent forth the first note, when, poising myself firmly, I suddenly threw my right arm back, and with the force of a cannon-shot hurled the pulpy tomato through the open window. Never did bullet sped from rifle fly with truer aim—whiz! chuck! and Curltop's face was a variegated blotch of red and white—the voice struck a higher key, and changed into an unearthly yell of terror, then died off in a gasping whine; the eyes snapped in a vain attempt to close over a mass of sticky seeds, and, 'mid the prolonged screams of the females, the tall form toppled and fell—he had fainted—nor did the catastrophe end there; as a blasted tree carries its neighbors to earth when it falls, so did the stricken dandy carry to the carpet the terrified Kate, one music stool, two folios of music, one old gent in a bald head and specks, and at least two yards from the skirt of a silk dress. Had a shell exploded in their midst the consternation could not have been greater. It was not my purpose to be discovered, so with a bound I was in the house, and among the first to rush to the assistance of the fallen.

Their appearance, especially that of my foppish foe, was ludicrous in the extreme. Ill-concealed grins succeeded looks of fright and astonishment on the surrounding faces, and when at last he so far recovered as to sit up and glare around in stupefied amazement, a roar of laughter greeted him that shook the building. It was in vain that our hostesses looked grave, and Curltop hideously stern; fresh bursts of merriment were pealed forth, and many ran out and rolled over on the hall carpet in convulsive attempts to choke themselves off. A party who had gone in search of the miscreant who threw the vegetable, returned and reported want of success—no one was visible in the garden. Assisted by the deeply mortified Collier sisters, I raised the prostrate gent to a chair, where he soon recovered sufficiently to beg for a glass of wine, which was given him, and had the effect of reviving his suspended faculties. An offer from Kate to remove the crushed tomato from his dilapidated countenance was rudely rejected, and springing to his feet, he called for his hat, which he slammed savagely on his head, and assuming a ferocious look, and in language that savored more of the "Five Points" than "Broadway," consigned the house, its inmates, the town, and all it contained, to a certain sulphureous region not mentioned in geography; having done which, he marched disdainfully forth into the darkness, followed by renewed peals of laughter. Close behind him went the indignant "Gilpins," refusing to be comforted, and breathing vengeance on all concerned in the foul assault on the person of their particular friend from the city. It is needless to say that I cut the acquaintance of the charming Miss Kate, who, by the way, was dreadfully annoyed for months after by certain rival beauties, who lost no opportunity of making impertinent allusions to tomatoes

and city gents. It was long before it was known who threw that tomato, and, mean as the act really was, but few blamed me. To this day, the people about Bruntwood tell with great gusto, how Billy Hawkins "busted" a big tomato on the head of a dandy chap from York.

For the New York Coach-maker's Magazine.

### THE HORSE.

MR. DICKENS says: "I object to the personal appearance of the Horse. I protest against the conventional idea of beauty as attached to that animal. I think his nose too long, his forehead too low, and his legs (except in the case of the cart horse) ridiculously thin, by comparison with the size of his body."

If Providence didn't know how to make the horse what he ought to be, Mr. Dickens is right.

Mr. Dickens also informs his readers: "Again, considering how big an animal he is, I object to the contemptible delicacy of his constitution. Is he not the sickliest creature in creation? Does any child catch cold as easily as a horse?"

May not the delicacy of this useful animal be the result of man's treatment rather than that of his natural constitution? Mr. Prime, who knows much about Arabian horses, gives us new information. It appears from his observations that horses in Arabia are little cared for—although we read many interesting stories of the Arabs' love for their horses. He says: "Seldom covered and never housed, it is often a subject of the utmost astonishment that the Arab horses do not perish from exposure. But for their incredible powers of endurance, they would undoubtedly do so. After a long day's journey, or a sharp ride of hours over precipitous paths, without food or water on the way, or halt, the horse is left standing in the air, the saddle is not removed, being a substitute for clothing, as well as a preservative against sharp stones, if she\* rolls, and while the rider lies under the shelter of his black tent, or on the ground, wrapped in his *boornose*, the steed shivers in the desert star-light; but she is not the less ready for the road in the morning."

But without going to Arabia, let us look at the treatment of horses in our own country. How often is a fine horse driven fast as the wind, until he is sweltering in foaming sweat, then let shiver in the cold, and then blamed because he takes cold!

Again, Mr. Dickens says: "Does he not sprain his fetlock, for all his appearance of strength, as easily as I sprain my ankle?"

When an awkward person drives a horse as he should not be driven, he sprains his fetlock as easy as Mr. D. sprains his ankle.

Again he says: "Furthermore, to take him from another point of view, what a helpless wretch he is! No fine lady requires more constant waiting on than a horse. Other animals can make their own toilette; he must have a groom. You will tell me that this is because we want to make his coat artificially glossy. Glossy! Come home with me, and see my cat—my clever cat who can groom herself! Look at your own dog! See how the intelligent creature curry-combs himself with his own honest teeth!"

Now, if a horse could only live without eating, and would not die, as some horses do when they are trained to do this thing, and if he could be abused in every other way

\* The Arabs prefer the mare to the horse.

without injury to his constitution, and like a cat could lick himself clean (that is, if he was eat and horse too), and like Mr. Dickens' intelligent dog could curry-comb himself with his own honest teeth and nobody else's, Nature would have made the horse well, and Mr. Dickens would have been pleased. But now all is wrong, because she did not do her work right.

He says: "I accuse him boldly, in his capacity of servant to man, of slyness and treachery. I brand him publicly, no matter how mild he may look about the eyes, or how sleek he may be about the coat, as a systematic betrayer, whenever he can get the chance of confidence reposed in him."

If the horse is laden beyond his strength, goaded unmercifully, or has steel spurs driven into his ribs, he must on no account kick or even feel dissatisfied, but draw his load with all his might, even to the dislocation of his joints. Now Mr. Dickens is no horse or ass either, and how would he like to be spurred in the ribs? But authors have sweet tempers, and they can bear any thing.

Mr. Dickens has yet another charge to make: "Then again, what a fool the horse is—what a poor nervous fool! He will start at a piece of white paper in the road as if it were a lion. His one idea, when he hears a noise he is not accustomed to, is to run away from it. What do you say of these two common instances of the sense and courage of this absurdly over-praised animal? I might multiply them by two hundred, if I choose to exert my mind and waste my breath, which I can never do."

This distinguished author does well not to waste his breath, lest he might exhaust himself. If Edward Young had known what Mr. Dickens says about the horse's fear, nervousness, and foolishness, do you think he would have written the following lines? I think he would:

"Survey the warlike horse! didst thou invest  
With thunder his robust distended chest?  
No sense of fear his dauntless soul allays;  
'Tis dreadful to behold his nostrils blaze;  
To paw the vale he proudly takes delight,  
And triumphs in the fullness of his might;  
High raised, he snuffs the battle from afar,  
And burns to plunge amid the raging war;  
And mocks at death, and throws his foam around,  
And in a storm of fury shakes the ground.  
How doth his firm, his rising heart advance,  
Full on the brandished sword and shaken lance;  
While his fixed eyeballs meet the dazzling shield,  
Gaze, and return the lightning of the field.  
He sinks the sense of pain in generous pride,  
Nor feels the shaft that trembles in his side;  
But neighs to the shrill trumpet's dreadful blast  
Till death; and when he groans, he groans his last."

Or why did Dryden write,

"The fiery courser, when he hears from far  
The sprightly trumpets and the shouts of war,  
Pricks up his ears, and trembling with delight,  
Shifts place, and paws, and hopes the promised fight;  
On his right shoulder his thick mane reclined,  
Ruffles at speed, and dances in the wind.  
Eager he stands, then, starting with a bound,  
He turns the turf, and shakes the solid ground;  
Fire from his eyes, clouds from his nostrils flow,  
He bears his rider headlong on the foe?"

Or why should Byron sing,

"With flowing tail and flying mane,  
With nostrils never stretched by pain,  
Mouths bloodless to the bit or rein;  
And feet that iron never shod,

And flanks unscarred by spur or rod,  
A thousand horse—the wild—the free—  
Like waves that follow o'er the sea,  
Came thickly thundering on?"

The horse is one of man's chief helpers, for he is the right arm of a nation's power on hard-contested fields; and he labors in the cultivation of the soil—on the unstained fields of peace, where he helps to make them smile beneath the hand of cultivation. There are Arabian proverbs of great beauty. Thus: "Horses of pure race have no vice." "Horses are birds without wings." "He who forgets the beauty of horses for the beauty of women, will never prosper." "Barley will make the horse run," etc.

The horse is one of the most beautiful and useful animals in nature. Who can behold his fine skin, large veins, delicate limbs, expanded nostrils, full beaming eyes, and not feel within his soul a glow of affection for the horse?

Listen to the language of the inspired Job:

"Hast thou given the horse strength? Hast thou clothed his neck with thunder? Canst thou make him afraid as a grasshopper? The glory of his nostrils is terrible. He paweth in the valley, and rejoiceth in his strength: he goeth on to meet the armed men. He moeth at fear, and is not affrighted; neither turneth he back from the sword. The quiver rattleth against him, the glittering spear and the shield. He swalloweth the ground with fierceness and rage; neither believeth he that it is the sound of the trumpet. He saith among the trumpets, ha, ha; and he smelleth the battle afar off, the thunder of the captains, and the shouting."

The horse has in all ages been an interesting theme in the history of nations, whether we refer to the age of chivalry, the Olympic games, or the blood-stained battlefield, where he stood dauntless amid the booming of cannon, and the glittering spears of warriors. Burke once said, "For in all things whatever, the mind is the most valuable and most important, and in this scale the whole of agriculture is in a natural and just order; the beast is an informing principle to the plow and cart; the laborer is as reason to the beast, and the farmer is a thinking and presiding principle to the laborer."

How frequently is the dividing line between the reason of the one and the instinct of the other, scarcely perceptible! Until the light of civilization dawns on the mind of the savage, he feels no desire for the domestication of any living thing; but as he becomes refined by a progressive social intercourse, less of cruelty and more of humanity reigns in his heart. But to return from this digression. The horse has not the ability to express in language the sufferings of disease, or those of inhuman treatment; he is not endowed with language as a vehicle of thought, to speak the pangs of excruciating pain, whether from unmerciful whipping, lameness from bad shoeing, or any other cause whatever. How often has a passionate driver struck a horse with the handle of his whip behind the ears, thus laying a basis for the disease known as poll evil?

The next injury to this worthy animal, is to subject him to the quackery of some village farrier, or perhaps to that of the tyrant who inflicted the wound, because the latter may not desire to make known to his employer the mischief he has himself done. The barbarous practice of nicking and doeking, which constitutes a fruitful source of mortification and lock-jaw, is a species of cruelty which is becoming unfashionable, and the *modus operandi* of which ought

to excite disgust in the beholder. Jockeys used to say that "Nicking and docking give increased strength," but

"God never made his work for man to mend."

The cruelty inflicted by those who drive public conveyances, is to be seen every day in our streets. The race horse, beautiful as he is, has often been run beyond the powers of his endurance; the orders of the owners frequently are to *win the race or kill the horse*, and sometimes they do both, and not unfrequently the latter. Some veterinary students are in the habit of going to the knackers to purchase condemned animals for the purpose of performing on them the various operations of firing on the leg, fetlock, coronet, and hock; they trephine, nick, and dock, and insert setons in almost every direction, as if to ascertain how long before life would become extinct under such treatment. This system of practice is not necessary; deceased animals alone should be operated on in the presence of the students' professor, who could explain wherein their errors of practice lay. The establishment of humanity in the heart of man would do more to ameliorate the condition of the horse than the combined efforts of the veterinary faculty are able to accomplish.

The Arab loves his horse; he gives him barley to make him run; his family often lie in the same tent with him; the wife feeds him, the children caress and play with him, and it is wonderful how this companionship with man increases his affection. A tribe of Arabs once attacked a caravan on its way to Damascus, but before their escape the horsemen of the Pasha of Acre made them prisoners. On their way to Acre the whole party encamped on the mountain of *Saf-hadt*. Abou el Masseh was one of this tribe; his legs were tied together by a belt, and he lay beside the Turks as a prisoner. During the night the pain of his wounds awoke him; his horse was at a short distance, picketed at the tent, according to the Eastern custom. Abou el Masseh heard the neighing voice of his own horse, the courser of the desert and companion of his life, and he crawled on his hands and knees, manacled as he was, and said to him: "My poor friend, what canst thou do amongst those Turks? Thou wilt be imprisoned under the roof of a khan with the horses of an Aga or Pasha. The women and the children will no longer bring thee the camel's milk, or barley or doura in their palms. Thou wilt no more course the desert like the wind from Egypt. No more wilt thou divide with thy chest the refreshing waves of Jordan. Oh! that if I remain a slave, I could render thee at least free! Let me try! There, go! return to our tents, tell my wife that Abou el Masseh returns to it no more, and lick the hands of my children." Abou el Masseh gnawed the fastening of goat's hair, and gave the animal his freedom.

On seeing his master unable to walk, for he was manacled and bound at the feet, he seized him by the leathern girdle around his waist, and galloped away with him to his tent. He laid him on the sand, and from fatigue the faithful horse fell to the ground and expired. The whole Arab tribe mourned his loss, and the poets sang his merits.

The affection of the horse when kindly treated, and his usefulness to man, should plant a desire in the human breast to

"Put a whip in every honest hand,  
To lash the rascal naked through the world,"

who would be guilty of cruelty to the noble horse. L.

For the New York Coach-maker's Magazine.

## ARE YOU AN HONEST MAN?

BY S. E. TODD, ESQ.

(Second Article.)

"LET me record his praise—the honest man!  
The law of love was in his heart, alive:  
What he possessed, he counted not his own.  
He needed not the law of State to force  
Grudging submission to the law of God."—POLLOCK.

PERHAPS there never was a time, since the commencement of the Christian era, when there were such great temptations in the way of all classes of citizens, both old and young, wealthy and poverty-stricken, as at the present, to yield to the wicked and debasing vice of dishonesty. There is such a universal thirst and hasty rage to gain wealth, and the style of living, and every description of wearing apparel are so very expensive, that there exists incomparably greater danger of being ensnared in some dishonest scheme, than the world has ever before experienced. Pleasure-seeking young people have so many things to see, and so many places of amusement, gayety, and festivity to resort to, and they read and hear of so many beauties to be seen and enjoyed, that, in their eagerness to appear in as good style, and in as costly dress as those who possess abundant means for all the pleasures and luxuries of life, they lose sight of the *means* by which they obtain what they desire, and soon glide into the dishonest and dishonorable practice of fluttering in brocade at the expense of some one else. There are, doubtless, many circumstances in which almost every young man is placed, when he cannot honestly look into his own heart, and candidly say, *I am an honest man*. When young men—and women too—arrive at an age when they are acting for themselves, if they have not received a pretty thorough course of discipline in business affairs, and have not good habits, well established on principles of strictest equity in all their intercourse with their fellow-men, little manifestations of dishonesty will occasionally appear, and, before they are aware of it, the reproach will be hurled at them, *You are not an honest man*. Our first impressions of a person are, too often, as that person really is; and although we cannot draw aside the veil, and look into the heart of another, and be able to tell whether or not he is actuated by the principles of a truly honest man, still something seems to whisper to us, when we are forming conclusions in reference to the characters of certain others, and to influence us in such a manner, that we almost unconsciously pronounce such an one a man in whom we are not afraid to confide. Such an one *will*, almost always, prove to be an honest man. On the contrary, we meet with individuals, associate with them, have dealt with them, and are not able to point to a single act of dishonesty in all their lives, in whom we dare not repose implicit confidence until we have divested ourselves of our very first convictions.

When a man is truly honest, the fact will be fairly disclosed to the conviction of every one who is particularly concerned or interested in the case. When a man who is, and always has been truly honest, is arraigned for any supposed or suspected offense, the incidental facts and circumstances will always appear in such a light, that the universal voice will be, *He is an honest man!* Individuals have been arraigned, many times, and received the merited deserts of

malefactors, when the positive evidence necessary for convicting them was entirely wanting; but there is no reason for believing that there was ever a man arraigned, convicted and punished, according to the laws of a civilized and nominally Christian nation, who could declare, in the honesty and sincerity of his heart, *I am an honest man.*

*What constitutes an honest man?* A man who always does right, and is actuated by correct principles. A man who defrauds another, either openly or in secret, or oversteps the bounds of propriety, cannot expect to receive the name of an honest man. The man who has forgotten more than I ever expect to know, and wilyly "robs me of my good name," or by his unmitigated falsehoods obtains any of my possessions, is by no means an honest man; but he who never takes advantage of my ignorance, and is not unwilling to have all his motives and actions disclosed as they truly are, to the scrutiny of the world, and who can stand up before all who know him, and declare that he has coveted no man's silver, or other possessions, he is an honest man. A man who is truly honest in every thing he does or says, will be actuated by *principles of honesty*, and not merely by a desire to have others *think* he is an honest man, when he is restrained from knavery only by the consideration that should certain actions be brought to light, his reputation for honesty would not be respected.

There can be no plausible excuse at the present age, for not being actuated in all we do and say by disinterested honesty. We need but little of the wealth of the world, to supply every real necessity and comfort.\* Those who possess wealth beyond a limited computation, cannot appropriate but about so much of it—a very limited amount—towards making them happy and comfortable. There are but few in the world, who may not, by proper industry and prudence, obtain enough to render them comfortable and happy, if they have not an insatiable desire to satisfy. Here is the secret of so much dishonesty as we meet with at the present day. Multitudes of people are prompted by a *morbid desire* to possess this, or that, merely to gratify *that* desire. They need no more to render them comfortable or happy; for they have an abundance of means to procure all the luxuries and necessaries which they can make use of; and on the score of benevolence and beneficence, they have no object in view.

When a young man commences his career in life, he should aim and strive to be an honest man. If he expects to prosper in business, and to share the respect which a worthy and estimable citizen receives, he should determine to maintain a character and reputation for genuine honesty. It may cost him many an inward struggle to do right, and he may be under the necessity of resolving often and re-resolving, that for the future he will be guilty of no act of dishonesty towards any one in the most trivial affair. If such resolutions are formed with an honest purpose to do right in little things, dishonest thoughts and dishonest intentions will soon be looked upon as something most abominable, and a man will be respected by

\*A classical writer says, *Ille non est dives, cujus pecuni argatur; sed ille, cujus animus est tranquillus.* We have been taught from our school-days, the exploded doctrine,

"Man wants but little here below,  
Nor wants that little long;"

yet we believe with the Latin author, "He is not rich whose money is increased, but he whose mind is tranquil;" consequently man *needs* but little here below to make him happy. The poet's "want" must have been differently understood in his age, or else the times have sadly changed since. Our *imaginary* wants are truly alarming; and these are what give us so much trouble. Our *wants* are threefold more than our needs.—Ed.

every one, and be raised much higher in his own estimation of himself, when he can meet friend or foe without dodging behind the door, or turning his back, or sneaking around some corner, when about to meet some one whom he has wronged, and think, without being self-rebuked, *I am an honest man.*

"Be an honest man of brightest model,  
Of that high and perfect beauty,  
When the mind, and soul, and body,  
Blend to work out life's great duty."

## The Home Circle.

For the New York Coach-maker's Magazine.

### THE OUTLAW'S BRIDE.

A SKETCH FROM THE UNWRITTEN REMINISCENCES OF AN  
IRISH REBEL.

(Concluded from page 109.)

By five o'clock we were in the Mersey, and precisely at eight I found myself the guest of Mrs. Ferguson, to whom, with all due deference to my connubial identification with the British army, as the *wife* of a commissioned officer upon actual service, I was most respectfully introduced by her husband. With Mrs. Ferguson, my position, as defined by my worthy fellow-traveler, was a guarantee that, although an *Irishwoman*, I was strictly "within the pale" of "civilization!" Mrs. Ferguson was a well-fed, bright-eyed, ignorant, dapper little English girl, daughter of an old Liverpool tide-waiter, from whom she inherited a rather cordial aversion to her fellow-subjects of the "sister island," and it was therefore that her liberal exception in my favor at once entitled her to my warm congratulation upon the good fortune of not having had the lot of so accomplished and amiable a lady as herself cast among so *disloyal* and *uncultivated* a people—and above all, so *ungrateful* to their *English benefactors (!) as the Irish.*

Here was duplicity with a vengeance! Ungrateful! English benefactors! I thought the latter words would have choked me.

Without participating in our conversation, Mr. Ferguson marked with pleased attention the progress of our mutual explanations, touching those principles of a common *loyalty*, and those charitable aversions to Ireland and the Irish, which were rapidly forming the basis of a friendship—as cordial as it was sudden—between Mrs. Ferguson and myself. And thus we had formed a comfortable tea-party, and the meal had just been concluded, when a foot was heard upon the stairs, and presently a hurried knocking at the door, accompanied by an inquiry as to whether Mr. Ferguson was at home.

The subject of the inquiry literally jumped to the door. "Ot 'ome, hand hot ye'er service," says Mr. Ferguson, to a square, burly individual, half buttoned up in a large great-coat, under which the uniform of the Liverpool police was partially discernible. The stranger, without a word, hastily produced a written paper, which both repeatedly ran over together, but in suppressed tones, so that no person at a yard's distance could possibly catch a word of the contents. With a strong effort to suppress some evident anxiety, Mr. Ferguson at length stepped back into the room, seized his hat, armed himself with a dagger which had been lying on the mantle-shelf, whispered a few words to his wife, and then tore down stairs and into the street,

accompanied, or rather preceded, by the party whose mysterious mission will, by and by, be fully explained.

I remained silent—possibly flattered myself that I had preserved an air of thorough indifference to the whole affair; but I thought I felt the blood retreating from my cheeks, and curdling around my heart in chill and immovable stagnation. Nor did I, I must confess, experience much relief from the sort of significant soliloquy in which Mrs. Ferguson proceeded to give utterance to her rather extensive knowledge of the objects and *incentives* of the recent movement.

"Woll, hi zed zo! Knowed hit wud gum to this! No ketchin a skin of 'em hover hin that there Hoirland; hon 'onest man can't make ha lawful penny by 'anging them—too 'ard to grab 'em for that! Three weeks hin Hoirland—honly think of hid—han two 'undred pounds' worth hov ha young roble here hunder hour very noses—one hov the hidetical cut-throats—but 'e'l get pounced hupon by and by: moi 'usband 'ill fatch 'em—'ee's not in Hoirland to-night, where the queen's henemys would hactually be-grudge a decent 'angman to make a guinea out of one of their neighbors, heven if he wuz hafter setting fire to the castle of Dublin."

"Setting fire to the castle," said I, interrupting this only too *intelligible* rigmarole, in which the speaker had so plainly indicated the degraded avocation of her husband, and the coarseness of her own nature. "Setting fire to the castle, even though the audacity of the act was completed by kicking her majesty's lord lieutenant into the sea, would, *I fear*, be at present attended by any thing but universal condemnation in Ireland."

"Ho, the ungrateful 'Ottentots! Han't ye happy, moi dear Mrs. Maxwell, to get from hamung them."

"*The luckiest event of my life!* And I have been just thinking, Mrs. Ferguson, of how foolish it was for you to intrust your excellent husband among such a set of savages."

"To tell you the truth, Mrs. Maxwell, moi 'usband is han hinterested party—he is hafter one or two of these eere Hoirish robes—one hin particular: two undred pounds is his government price—ee'l ketch id, a young villain, from—m—m—m."

"Sweet Tipperary, I suppose," says I.

"Tipperary," says she, "that's the place; and eere's his full description. Ee was traced to Liverpool, where ee arrived this hevning, hand hi ope poor Ferguson will nab the rogue, hand that we sha'n't get cheated hout of the proice of em."

Suiting the action to the word, she placed a copy of the Dublin Hue-and-Cry in my hand, pointing out, at the same time, my own exact personal description, as already quoted for the benefit of the reader, among the earlier passages of the present fragment.

"There he is," says Mrs. Ferguson, "hond moi 'usband will never lay a side by me until ee fetches em to the fore, dead hor halive."

I understood the position of matters, at once! To explain them, however, I must here return to the ever faithful Caroline O'Grady. On the night of our departure from the Galtees, Caroline, as a part of her programme, had assumed, like myself, a fictitious sex and character; and for that purpose—in short, to personate her lover—had so attired herself as to render the detection of the *role*—at least from casual observation—a highly improbable event. The object of this device was, of course, to concentrate upon her own movements, which were in a direction en-

tirely different from mine, such observations and suspicions as would be sure to generate erroneous rumors, and so divert "the authorities" from the pursuit of the *real*, to that of an imaginary *criminal*. While I, attired as a lady, had taken the route by Athlone, and thence to Liverpool by the Galway night mail and steamer, direct, Caroline, in the garb of a gentleman, had chosen the Southern and Western Railway, from Ballybrophy, the Holyhead packet, and the balance of her journey to our common destination, by way of Chester and Birkhead.

Owing to the assumption of a masculine disguise, and an almost incredible resemblance, not heretofore noticed, between her and myself, she had excited the suspicion of every spy—and they were more than a few—encountered throughout her journey. From Dublin she had been actually *dogged* to Liverpool; and it was in consequence of an accidental escape from the surveillance of her pursuer, and a desire upon the part of that assiduous agent of "the Crown" to effect the discovery and arrest of "*rebel*" No. 2, described in the Government Gazcttte, and so to clutch *two hundred pounds sterling*, lawful circulation of the realm, that the excellent Mr. Ferguson—an adept in the detective art—had been so suddenly called away from the presence of his wife and the society of Mrs. Maxwell.

The supposititious escapade of the Hue-and-Cry in the person of Miss O'Grady, had not, like myself, been over an hour in Liverpool, when Ferguson, with a *posse committatis* at his heels, armed for the adventure, and duly provided with a *letter-press* portrait, was sturdily upon the trail of his expected prey. Human success, however, is not always proportioned to the efforts for its achievement, and accordingly, Mr. Ferguson was doomed to disappointment: his perseverance was worthy of a better reward. This will be apparent from the tenor of the following brief communication, to Mrs. Ferguson, after a three hours' absence, unattended by any result:

"No chance yet; am busy among the cribs—must keep a sharp look-out all night—will board no vessels until morning—make no extra bed, Mrs. Maxwell can sleep with you—good night.

JOHN FERGUSON.

"Waterloo Road,  $\frac{1}{2}$  past 11."

Here was a predicament for an *Irish rebel!* That short missive, which its recipient confidentially read off for my edification, contained the materials for a volume of romance. All but a prisoner under the roof of the very man actually grasping for a reward for my apprehension, and that man positively giving instructions to his wife to adopt me as a bed-fellow!

"Horrible!" said I to myself, endeavoring at a picce of inward merriment, over the absurdity of the situation, although at the same time I thought I should have dropped dead off the chair.

Pale and crimson alternately usurped the dominion of my countenance. My appearance must have represented a cross between the modesty of a nun and the stolidity of a fool! Luckily, however, for the latter too evident feature in the combination, Mrs. Ferguson, in order to carry into effect the arrangement suggested by her husband, had betaken herself to an adjoining room, and there busied herself for a few moments in the adjustment of her dormitory for the reception of the favored guest with whom she was about to share its accommodations. But my embarrassment, upon her return, was doomed to a fresh aggrava-

tion. Presenting me with a heavy-bordered night-cap and ruffled *robe de chambre*—my hostess, in the excess of her assiduity—now requested me to undress, adding at the same time a suggestion as to the necessity of bathing my feet after the fatigue of my journey!

I thanked her for these courtesies, politely declined the proffered foot-pan, and fumbled the habiliments of the bed-chamber awkwardly in my fingers, just retaining sufficient breath to beg permission to retire. This granted, and reflecting on my escape from an operation—the necessary preparation for which would have inevitably revealed the presence of a pair of cassimere pantaloons which I had worn by way of an under-dress—I strode into the room, undid my toilet as best I could, hastily slipped on my night-gear, and while Mrs. Ferguson was occupied with a similar process, in the next apartment, over a smoking libation of mulled porter, I had taken up my quarters for the night, fully resigned to whatever fate might succeed to the interesting vicissitudes of which I was now the subject.

Mrs. Ferguson turned in by and by; she slept soundly; a couple of quarts of porter, mulled and gingered to the English palate, was a potation by no means unlikely to produce such a result. At four o'clock in the morning the narcotic properties of the dose still continued to manifest their power over the faculties of my bed-fellow; at that hour she did not seem as if she intended to waken for a week. In my case, the sense of my situation was too acute for an acquaintance with the "drowsy god," and my waking reveries merged themselves into a sublime resignation with but little hope for the contingency of a possible deliverance.

Miss O'Grady and I were to meet—if at all—at the house of one Donovan, a sterling trump of a Milesian tailor, who had been reared under our maternal grandfather, and who had, in advance, been confidentially advised of every thing connected with our movements. This, our intended rendezvous, was situated in a narrow dirty lane, somewhere in the vicinity of the quays, and, luckily for myself, the name was then pat upon my lips—I entirely forget it now. Taking an unceremonious leave of Mrs. Ferguson, still in a sleep too profound to be broken by the movement, making a hasty toilet, slipping noiselessly down stairs and effecting an exit to the street, I succeeded in making my way, by the light of the half-extinguished street-lamps, and a single inquiry of a drowsy watchman, to the premises of my goodly friend, Mr. Donovan.

I was so fortunate as to find Mr. Donovan astir. He kept a sailors' slop-shop, and was vigorously plying the "goose" upon the last seam of a monkey-jacket. The garment—as it turned out—was for myself. In less time than I can write it, I was transformed, by the aid of this nimble artisan, from the demure *Mrs. Maxwell* into a veritable Jack-tar, and so far as appearances were concerned, might have applied, with impunity, for a berth before the mast. Miss Caroline, in the less eccentric costume of a male civilian, had made good her destination on the previous evening; and interpreting a sly wink of the faithful tailor into a revelation of her whereabouts, I squeezed myself up a narrow stairway, and soon found the heroine of the Galtees rejoicing in the genuine Munster hospitality of Mrs. Donovan. We looked at each other for a moment or two in silence, and then both broke out—as by a common impulse—into a wild uproarious laugh, which certainly was not to be accounted for either by the situation or the prospects of the moment.

Each was in utter ignorance of the adventures of the

other; and time—that mighty element in the problem of our escape, now on the verge of final solution—was too precious to be squandered upon mutual explanations—there was not an instant to be lost. The first ship for America—the *New World*, for New York—had been floated into the stream upon the last tide; she had eight hundred passengers on board, and Mr. Donovan was already off to make arrangements for adding two more individuals to the number. Quarter of an hour sufficed for the accomplishment of his mission: he had secured a suitable accommodation for Miss O'Grady, with a family of his acquaintance, which included three young girls, amply provided for the voyage, with enough to spare (and hearts to share it) for the necessities of their adopted companion. These excellent ladies—the Miss Colemans by name—had been hastily apprised of the position and *disguises* of their fellow-travelers, and were prepared to act in the case as circumstances required.

With these assurances, and as the anchor was already heaving, we boldly sallied into the street; and, with Donovan and myself in advance, and Miss O'Grady, with green frock coat, striped cassimere pants, speckled vest, white hat, and high-heeled boots, following in our wake, at a not too familiar distance, we got safely on board the steamer taking the officers and some passengers to the ship, and also chartered to tow the latter down the bay. But scarcely had our craft moved ten yards from the shore, when my friend, John Ferguson, with half the police of Liverpool at his back, made his appearance. The man was in a frenzy of excitement; the gestures, signals, and mandates by which he essayed to enforce the return of the boat were absolutely too violent either for the thirst of lucre or the zeal of duty: they were prompted by a more terrible impulse; but they exhausted themselves without a result.

With John's indications of insanity, as I looked him full in the face from the wheel-house of the steamer, now persistently widening the distance between us, a startling oversight flashed across my memory: I had forgotten my valise in the bed-room of Mrs. Ferguson! Its contents would have betrayed me a dozen times over! *Clothes*, manuscripts, letters—I saw it all! Mr. Ferguson had been at home; the discovery that the subject of his attentions, as an actual fellow-traveler from the Shannon to the Mersey, and, what was worse, the recipient of his domestic hospitality, was no other than the very outlaw for whose apprehension he had been laboring; the culpability of his wife in permitting the escape of the Irish impostor; and—ten thousand times more galling than all—the evidence of downright guilt into which his frenzy had interpreted her silent amazement: all this—so safe with the imagination of the reader—was too much for the man; and it was not without a persevering struggle that he was finally to be cheated out of the offender.

Mr. Ferguson, in the pursuit of his imaginary prey, had caught sight of my living *duplicate*, as she stepped on board the steamer; the description of *myself*, as contained in the government gazette, applied in every visible particular: and he at once jumped to the conclusion that my cousin Caroline—the personage who had thus attracted his attention, and who, as he supposed, had just effected an exchange of attire—was the identical Tipperary "rebel" who, in the garb of a lady, had played him such a combination of deceptions, under the incognito of *Mrs. Maxwell!*

Hitherto, Mr. Ferguson had been influenced in his efforts for my capture by the mere sentiment of *loyalty*—which simply meant the prospect of pecuniary reward; the thirst of vengeance was now superadded, as a still more powerful incentive.

The New World, already under way, is boarded by an armed long-boat; Ferguson, with his brain on fire, and followed by a host of invaders, wildly jumps upon the deck; berth-decks and cabins, hold, store-rooms, caboose and fore-castle—even to the very chests and meal-tubs of the passengers—every nook and crevice of the vessel is inquisitorially overhauled and examined—of course, “in the name and on the behalf of our sovereign lady” Victoria the First, by the grace of God, and so forth.

It was all to no purpose. The Miss Colemans had not been idle with their fair *protégée*: the green frock, the white hat, and their corresponding *etceteras*, had been exchanged for a more congenial garb, and Caroline O'Grady was among the first to brave the scrutiny of Mr. Ferguson, in the simple attire of a female emigrant.

As for me, the real offender—if offender there was any—I looked, unheeded, and with conscious impunity, from under the brim of my sou'-wester; my enjoyment of the scene being only modified by the regret that an awkward combination of circumstances should have cast upon the really innocent Mrs. Ferguson, a stigma as unmerited as any that had ever rested upon the honor of woman.

Browbeaten, disappointed, and followed by the jeers and groans of eight hundred voices, Ferguson and his myrmidons took their departure. In thirty days the noble ship dropped her anchors abreast of the Quarantine at Staten Island, and in six hours afterwards, the *union* whose conditions had been adjusted upon the banks of the Suir, was formally consummated upon those of the Hudson.

Twelve years have nearly elapsed since then. The pledges of our mutual devotion are rising up around us; our fortunes have justified the resolution with which we faced them; a rude world, it is true, has not left us wholly unfamiliar with its trials; but, through every change, we have been able to recall, without a regret, except for those we left behind, the circumstances under which the heroine of the Galtees became that which harmonized so well with the aspirations of her youth—an Outlaw's Bride.

For the New York Coach-maker's Magazine.

MEMORY.

BY LIA DELINN.

WHERE are the hard-earned stores of truth?  
They come not back with lighter things,  
From out our long-departed youth,  
That Memory at our bidding brings.  
O Memory!  
That thou shouldst be  
So faithless! All we prize the most,  
The dearest bought, is soonest lost.

Forgive! thou art a faithful friend;  
Who trusts to thee, securely builds—  
The Mortal and Immortal blend,  
No more than light with dust it gilds.  
Eternal power  
Is thine; and our  
Nature immortal will in thy trust,  
Find all that seemed lost in Mortality's dust.

For the New York Coach-maker's Magazine.

HOUSEHOLD HYMN AT RETIRING.

BY MRS. L. H. SIGOURNEY.

DEFEND us, Lord: the night hath come,  
Set angel-guards around our home;  
For sinful men in crime grow bold,  
And lynx-eyed robbers prowl for gold.  
Keep us from violence and wrong,  
For we are weak, and Thou art strong.

Defend us, Lord, from fear and care,  
Whose wrinkling livery we wear;  
And bid us, from suspicion free,  
Have faith in others and in Thee;  
And sweetly light the darkest shade  
With love for all Thine hand hath made.

Defend us, Lord: our boasted power  
Avails not at the midnight hour;  
From dreams may burst devouring flame,  
The assassin strike with deadly aim,  
The dark-winged pestilence invade,  
And all our treasures fleet or fade.

Defend us, Lord: we are but dust;  
No arm, save Thine, have we to trust.  
And when the morning's radiant eye  
Looks through the windows of the sky,  
Oh! bid us rise from healthful rest  
In Thy divine protection blest.

Defend us, Lord: to Thee we cling;  
Thou art our Father and our King;  
From the first feeble cry of birth  
Thy hand hath led us o'er the earth;  
So guide us till our latest sigh,  
And take us to a home on high.

HARTFORD, Conn., Nov. 3d, 1859.

[With the above lines, we have received from the hand of the gifted authoress, whose whole life has been devotedly spent in promoting the happiness of mankind, the following characteristic note, which, on account of its spirit, we are sure will interest our readers, and in publishing which, we trust our fair correspondent will pardon us.—ED.]

HARTFORD, Conn., Nov. 3d, 1859.

To the Editor of the N. Y. Coach-maker's Magazine:

MY DEAR SIR—I send a poem to your periodical, as a mark of respect for the mechanical science it so well illustrates. It would give me pleasure to think that this simple hymn should be sometimes sung at retiring, in those families where useful industry, the true strength of our country, is practically honored. Very respectfully,

L. H. S.

GODEY'S LADY'S BOOK.—The December number of this monthly, just received, closes the fifty-ninth volume. Our lady readers—and they are many—will do well to subscribe with the January number, which commences a volume, and thereby secure a fund of amusement and instruction nowhere else to be found for the same low price—\$3.

## Pen Illustrations of the Drafts.

For the New York Coach-maker's Magazine.

MESSRS. KINGSBURY AND WHITEHEAD'S OVAL HEARSE.

*Illustrated on Plates XXII. and XXIII.*

THROUGH the kindness of Messrs. Kingsbury & Whitehead, of Albany, New York, the designers and builders, we are this month enabled to present our readers with a draft of a Hearse which is said by those who have seen it, to surpass in beauty of proportions and elegance of finish any thing of the kind yet made in this country. It formed a prominent object of curiosity in the late State Agricultural Fair, at the State capital. Being constructed on a principle very original, it is relieved of those disagreeable appearances which are peculiar to most vehicles of the kind, while at the same time the coffin is fully exposed to the view, resting on a beautifully arranged table, standing on a green ground, in the centre. Under the coffin and on the table are arranged silver rollers, which raise the coffin clear of the table.

As will be seen in the draft, the outside of the body is artistically carved, with scroll-work extending around the glass, forming a chaste and beautiful frame-work for the same. The inside is trimmed with black velvet cloth, with heavy bullion fringe and tassels. The oval glass to the sides is about 38 by 80 inches. The back is round, with doors, finished to correspond with the sides, as the drawing shows. The roof is ornamented with eight drooping plumes, set in silver sockets. The inverted torches at the back are also silver. With the correct drawing which we give, we think our readers will fully understand the remaining details.

For the New York Coach-maker's Magazine.

CUTTER SLEIGH.

*Illustrated on Plate XXIV.*

BINGHAMTON, N. Y., Nov. 1, 1859.

MR. STRATTON: *Dear Sir*—Inclosed you will find a draft of a cutter after the Albany style. It is drawn one-half inch to the foot. This style of a cutter makes a fine sleigh when neatly finished, and sells from \$60 to \$100, according to the costs of finishing. In this design a carved eagle-head is shown, with patent leather arm-pieces, neatly stitched or stamped; the former looks the neatest. The wings are covered sometimes with patent leather, very often with russet leather unfinished; when covered with unfinished leather the front side of the wings should be painted of the same color as the running part, a light orange (some paint the running part vermilion), and the back part of the wings the same as the body, either lake or a blue color. Some paint the arm-piece a Chinese white, which gives the job, when done, a light appearance, finishing it with a gold stripe, three sixteenths of an inch wide, with a hair stripe added to each side. I think that plain striping looks the neatest. The back is finished with a sweep-back, to which a moulding is applied, giving it the appearance of the back of a coach.

We make the runners track from three feet to three feet two inches wide. The body-raves for a swelled side should be placed two feet six inches apart on the beams, measured from the outside. Splice the top-rave to the arm-piece,

and afterwards lap and fasten the ends to the body rave, and let it project four or five inches from it, so as to give it a side-swell.

Trim the arm-pieces and back with red plush, using seaming lace; and from the patent-leather arm-pieces to the necks use three-eighths angle moulding. This makes a nice finish. If you think this cutter looks well enough to publish, please introduce it to the craft.

Yours in haste,

S. W. SPALDING.

DOG-CART PHAETON.

*Illustrated on Plate XXIV.*

THIS carriage we copy from our cotemporary, *The Carriage-Builders' and Harness-Makers' Art Journal*. It presents some features different from any thing we have heretofore given in our Magazine. These will serve to augment our readers' stock of ideas. We think, however, we could improve our cotemporary's stick-seat, but that is a matter of taste with which we have nothing to do in this instance. A carriage constructed as this is, is very convenient for short turning, which is very desirable in a sporting wagon. This vehicle will conveniently carry four persons, by dropping the back-board, which then serves as a foot-board, and allows the sportsman's dogs to enter the box easily.

DESCRIPTION OF THE CUTS OF CARRIAGES, ETC.

*Illustrated on Plate XXV.*

No. 1 is a close-quartered coach, with a hammer-cloth seat.

No. 2. Barouche with oval boot, hung on loops, and designed for a light summer-carriage.

No. 3. Coupé, hung low, and without steps.

No. 4. A six-seated square phaeton, for one or two horses.

No. 5. Cabriolet or park phaeton.

No. 6. Messrs. G. & D. Cook & Co.'s jump-seat Rockaway, which to build will require a purchase of the right from the patentees.

No. 7. Six-seat barouche, very stylish.

No. 8. Calash top buggy, square body.

No. 9. Calash top buggy, with Jenny Lind front.

No. 10. A buggy without a top.

These are but a few of the cuts we can bring into use in illustrating and filling orders for business catalogues and charts from carriage-makers. We have about one hundred and twenty different specimens, or less, according to the size of the charts that may be ordered at the prices mentioned below, when the money is sent with the orders. When to be collected on delivery, the additional charges made by the Express Co. will be added to all such bills, as we are obliged to pay for such service in all cases. As these cuts are finer and more correct than any we have heretofore supplied, and in consequence more expensive, we have been obliged to advance our prices:



SCALE OF PRICES, &C.

Catalogues, 48 pp. 12mo.

100 copies, -	\$38.76
200 " -	47.02
300 " -	61.28
400 " -	69.04
500 " -	75.13
750 " -	98.73
1000 " -	122.76
1500 " -	170.94
2000 " -	219.12

Charts, 22 x 28 inches.

100 copies, -	\$20.00
200 " -	25.00
300 " -	32.50
500 " -	42.90
750 " -	59.95
1000 " -	77.00
1500 " -	111.10

Special orders on cheap paper will be done by special agreement. Any special cut will be added to those we may have on hand, at the rate of \$2.50 each—the cut to belong to those for whom they are specially engraved, and to be delivered with the charts ordered.

Please forward your orders to us; we are confident you will be pleased with our work.

Sparks from the Anvil.

NEW MODE OF CONSTRUCTING SPRINGS.

THIS new mode of constructing springs has recently been patented by Thomas Spencer, of Newcastle, England, which, if not an improvement, yet is of such a novel character as to claim a place in our pages. It consists in form-



ing projections upon the surface of the plates, as may be seen in the engraving, instead of the nib and slaught, as heretofore used. It is claimed for these improvements, that in this new mode the rubbing of the surface of the under side of the spring is prevented, when in use. These laminated plates have the ends stamped in such a way that the convex or projecting portion of one rib, fits into the concave or recessed portion formed by the hollow on the next leaf or plate, thus securing the whole together in an effective and novel manner.

In connection with the above we may mention, that Reuben Brady, of 625 Houston street, New York, exhibited at the Fair of the American Institute, recently held in this city, a spring for which a patent has been applied for, very similar to the one above referred to. The differences are, that the "projections" are more angular than curvilinear in Mr. Brady's springs. He likewise couples the two halves of his elliptical spring in such a manner as to do away with the bolts usually employed to hold the two ends

together. We think the "flutings" of both claimants' springs are so nearly alike, as to render Mr. Brady's patent, should he obtain one, comparatively worthless.

For the New York Coach-maker's Magazine.

STAY-IRON FOR A COACH.

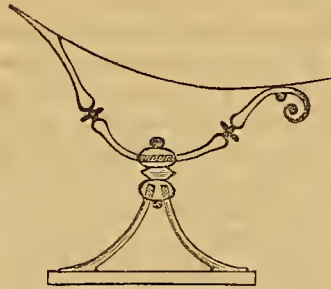

ON plate 14, Vol. I. will be found a Calash-Coach, the stay-iron under the front seat of which is not correctly shown, it being the fault of the engraver in shading. It is here represented on a larger scale of 3-4 inches. The centre-collar represents a malleable iron one, into which the stay-irons are screwed, as the section will show, and afterwards shaped and twisted as fancy dictates. J. I.

NICKEL AND IRON.

FROM the observation of the fact that meteoric iron is possessed of greater hardness and tenacity than the ordinary iron, it was thought by W. Fairbairn, F.R.S., that this property was due to the presence of nickel, which is found in all meteorolites. He has, therefore, recently been trying some experiments to test the fact. The nickel was combined with the iron in the same proportion as analysis had demonstrated that it had existed in a stone which had dropped from the clouds, and it was found that instead of increasing, it *decreased* the strength of the cast iron 17 per cent. He concludes his account of the experiments by remarking that he had conceived the idea that such an alloy would be most excellently adapted for large cannon and mortars, but that to resist the action of gunpowder there is nothing so good as the best and purest cast iron, and the more free from sulphur, phosphorus, or alloys, the better will it resist the violence of the explosion. The effect of nickel with malleable iron would, however, be as Mr. Fairbairn expected, namely, an increase of toughness, for carbon, phosphorus, and sulphur, which so much deteriorate the quality of cast iron, in small quantities, improve that of malleable, and it is not at all improbable that nickel would have the same effect. Some of our American-iron men should try the experiment and publish the result, as it would be an interesting addition to our knowledge of iron.

THE COAL OF WESTERN VIRGINIA.

FROM a long article on this subject in the *Lynchburgh Weekly Virginian*, we glean the following valuable information, which tends more and more to show that the mineral wealth of our country is greater than any other in the world: From what has already been discovered, it has been calculated that there is enough coal in this section of the country to supply the whole Mississippi valley with fuel for a thousand years, and fresh discoveries are being made in the Kanawha valley every day. All the coal yet discovered there is of a superior quality, both bituminous and cannel, and when the navigation is made more easy, and capital has turned its attention to that quarter, we have no doubt that coal from this region will find its way to every city in the Union, for it has already made its appearance in the Cincinnati market.

## Paint Room.

For the New York Coach-maker's Magazine.

### GOSSIP FOR THE PAINT SHOP.

BY E. E., BOSTON, MASS.

MR. EDITOR—When your agent visited Boston, and I bought your first volume, bound, and subscribed for the second, I hinted that I might, at some future time, throw out a few hints for the benefit of the Paint Shop; but in glancing over your articles on painting, I was half-afraid to do so, for I knew I could scarce make a beginning in the brief space in which some of your correspondents had instructed us how to paint a body, carriage, and all the fixings. Neither will I be so presumptuous as to dictate to any man the way this or that should be done, for I always give a man, that calls himself a painter, the credit of knowing as much and more than myself; for after thirteen years spent at the business, I find I have not learned every thing. There are things happening almost daily, which nothing but practice and experience can remedy; neither have I fully convinced myself of the utility of writing these papers, for it would be the highest kind of presumption to attempt to instruct a tradesman who has served his regular apprenticeship to his business, in the way he should do his work, and those men that have worked six months in a paint shop at rubbing, and perhaps have varnished a few old carriages, and think they know all, and pass off into other shops as journeymen. Men that have learnt their trade, and are guilty of cribbing loaf-sugar from their boarding-houses (a fact) to grind in paint, they don't know what for, but have seen (as they thought) other men use it; I say, for such men I have no sympathy. Let them go and sacrifice a few years, as all thorough workmen have to do, and go through the proper course of training, and they will get the benefit of it in after-years, should they continue to follow their business. Every employer knows how he is more or less imposed upon by inferior help; not only the employer, but the experienced workman that is placed in a shop with such help, to assist him, frequently has to do two thirds of the work himself, while his shop-mate's pay is within one, or at most two dollars a week of his own. So it is not the employer alone, but the workmen, who have to make up for the short-comings of others. Therefore, I think it is more on this account that this writing upon Painting is useful, as it gives the employer hints which are always profitable, and gives him a general understanding how his work should be done, so that he may say, as my employers said unto me on introducing your Magazine to me, "If we only get one little hint out of each number, it may be worth the price of a volume to us." Then, as I don't intend to say unto any man "You should do your work in this way, and not in that way," but as I wish every man that has a way of doing his work, and it gives both himself and employers satisfaction to continue to do it just so, and if there should be any thing in my remarks which he may think an improvement on his own way of doing his work, he is quite welcome to it. So what I have to say we will call "gossip," a social chat, how I was taught to paint how I do paint, and how I have seen other men paint carriages. Should I disagree with what other contributors have advanced in your Magazine, I do so in the most respectful manner, merely recording my own opinions, which all readers will take for what they are worth.

I know you cannot give me the space to go through and examine all the different colors which are used by coach-painters, and to remark upon their manufacture, and the adulterations which they undergo before reaching the paint-shop; but as good, pure white lead is the foundation of all carriage painting, I will direct a little more attention to that than any other. Most of your correspondents have been very scrupulous to assert how priming should be mixed, the exact quantity of this or that ingredient, as if the quality of the lead were nothing. But how seldom do you get good white lead, to say nothing of the pure article itself—lead that is next to impossible to put on even, no matter how or with what it is made—lead that, after it has been drying a few days, you can take your knife and scrape off like so much whiting or chalk. It is very little better, especially when prepared with inferior oil, in which a majority of ground lead is, which not only helps to give the lead, while in the keg, a darker shade than what it really is, but is injurious to its drying qualities. Of course, the whiter your lead appears, the more pure you take it to be, though at times you get very good lead which looks much darker than what you might expect it to be. Then after you get good lead, a great deal depends upon the oil you mix with it. It is, perhaps, more difficult to procure good oil than good lead.

I was told by a man of experience a sure way to test the qualities of linseed oil. I have never tried it, but common sense guarantees its correctness. It is to take a dipper of oil and put a piece of ice in it: all the impurities will thicken up similar to lard, while the pure oil will remain in its liquid state. I do not attach so much importance as most painters do, to using a little turpentine in your priming. Under certain circumstances it is very requisite that a little should be used. For instance, in making up a pot of priming, the painter takes keg lead, which, perhaps, has got hard and dry by standing, and mixes with nothing but boiled oil and Japan, perhaps both like so much molasses. Is it best to apply that, fat and greasy as it is, which is just like spreading so much varnish; or is it not better to thin with a little turpentine, and put on a nice even coat, which will not require a knife to scrape off the fat edges? I think it far preferable to use a little turpentine in your priming, than to run the risk of having to apply your second coat before your first is thoroughly dry.

I do not remember any great difference ever being made in "Hold Hingland" between the first, second, or third coats of lead. Patent-dryers and turpentine were used in every shop I worked in, for lead colors. Japan is not a good dryer for priming, and should be used as sparingly as possible; it helps to give lead that thick, heavy, sticky feel, which all painters, who like to use a free brush, detest. The English patent-dryer (which I have never seen in this country) is the best dryer for all solid colors I have ever used. It is a material similar to ground white lead, a shade darker, with very little body in it, and can always be depended upon. It gives lead a nice crisp surface, makes it sand-paper well, and is excellent for foundation colors.

Different men have different ways of preparing their priming; some will use all raw oil, just tinted with white lead, but not enough to hide the grain of the wood; others object to the least particle of lampblack being used in their lead, while others overdo it with black, and all are "down" upon using turpentine. To take the medium of these extremes is preferable, always suiting the circum-

stances to the case. If you prime a body over one day, and you know you will have no occasion to touch it for one week, why, prepare your paint accordingly. But if you know you have to give it the second coat on the following day, take every available means to have your paint to dry by that time. I would rather prime a body with quick drying lead color, and have it perfectly dry for the second painting, than use oil paint, which would not get quite hard before putting on the next coat—the job would wear better. As regards lampblack, it is not injurious to priming, as it possesses an oily substance of itself, and therefore can do no harm, but should be used very moderately. All that is required is to give your priming a nice, cleanly, light appearance. Making priming too dark gives work a heavy dull look, which it is as well to avoid. I think it much better for workmen, and very desirable to manufacturers who have a regard for the kind of stock they use, to always buy and use dry lead. There is not that chance to adulterate it as with ground keg lead. You purchase your own oil, and you have a chance of knowing better what you are using. There is no waste to it. A great deal of the ground lead stands in the market a considerable time before it is sold, and which gets dry and skinny, and proves unprofitable, even at a cent or two lower per pound than dry lead. Besides, you have the advantage of grinding dry lead to suit your own taste or as the job requires it, and it is always fresh and works much better.

I shall presume that all painters know how to give a body a coat of priming, although I attach as much importance to having a body well and properly primed as I do to having it properly varnished. If there be any difference, the priming should have the greatest attention; for if not particularly done, it may be the cause of all other misfortunes the job may undergo. The least paint used in priming the better, taking great care not to leave it thick upon the edges or to collect upon the moulding, but give it a clean, even, handsome coat all over. All iron work about a body, no matter whether in or out of sight, should have at least one coat of lead as a preventive against the atmosphere. All nail holes should be strictly attended to, making sure to have sufficient paint in them, for by putting a hole up with no paint in it, the wood will draw all the oil out of the putty, and at some future time your putty will drop out.

After you have let your body stand as long as you can do so, and have given the canvas inside a coat of paint, you can put on your second coat. Some putty up on the priming; it makes but very little difference, so long as your nail holes have had a good coat of paint. All putty used upon bodies should be what we call "hard stopper." Take dry white lead and mix with one-third turpentine and two-thirds English varnish, and pound it well up, until stiff to your liking. This should be allowed to get dry and hard before applying the next coat of paint. In this it is generally admitted that you can use more dryers and turpentine, especially if you have to put your job "through."

Your second coat you can put on more smoothly than your first, bearing in mind to put on as little paint as possible. If you wish to do your work right, you ought to sand-paper between every coat of lead. This, however, is optional, but there is no question but that it will make the work look more smooth and clean. It is the custom with some to give their work two, and with others, three coats

of oil lead. I was always instructed to give three. I think it much better than two. After giving your work, we will say three coats of oil lead, and putting it up, it will be ready for the filling or "rough stuff," and the question is asked, What kind of filling is needed, and how do you prepare it? Opinions upon filling are more conflicting than upon priming, but they can be narrowed down to a very small point. The old standard English filling is simply one part keg-lead and three parts yellow ochre, with equal parts of gold size and turpentine and a little varnish bottoms. There was never known to be any of those complications which your contributor in volume I, page 171, mentions, as putting so much raw oil and red lead in. It seems to me something bordering upon the ridiculous to prepare filling with red lead to dry it and raw oil to prevent it from drying, each in direct contradiction to the other. Depend upon it, the simpler you keep your preparations the more easily you can detect a fault. I have assisted at repainting old family chariots filled up with the above filling, which had run over twenty and near twenty-five years, and to all appearances the ground-work was as perfect as the year they were painted.

(To be continued.)

## Trimming Room.

### VEGETABLE LEATHER.

"NOTHING like leather" is an old expression, but in this age of discovery it would seem that there has been found a substitute, which, though it may seem paradoxical, yet is not only *like* it in some respects, but is said to be far superior, and even stronger, for some purposes, than the tanned animal hide. This is called vegetable leather, and it is said to be a capital substitute for leather in the tops and aprons of carriages. The basis of the fabric is a thick, close, twilled, textile material, coated on the outside with caoutchouc and other matters. These are chemically treated in such a manner as to defy the destructive action of the atmosphere and weather. In manufacturing this article, any color can be imparted to it, vivid and good. The composition coating has a grain imparted to its surface in imitation of leather, by employing rollers engraved for the purpose. The manufacturers produce very good imitations of enameled Russia, morocco, and other leathers. It can be manipulated in the ordinary manner, and gilt, embossed, or varnished, while it is supple and glossy, and is unaffected by alkalis or oils. It has been made five feet wide and three hundred feet long, and is pronounced stronger than leather, and can be furnished at one-third of its cost. Would it not be a good plan to have the top for a buggy formed so as to fit over the bows, and do away entirely with seaming, as must be done when leather is employed? We throw out the suggestion for the consideration of Yankee enterprise, believing there is nothing in this age like caoutchouc, which enters into articles almost innumerable for the convenience and comfort of mankind, in this age of invention.

## HARNES BUCKLES.

THE manufacture of buckles in this country now greatly exceeds the amount imported from Europe, both in number and quality. The cheaper kinds, now very little used in manufacturing carriages, mostly continue to be imported from Great Britain. Brass, which formerly was extensively used in making the larger kinds, has been superseded by steel and malleable iron, not so liable to bend or get out of order. The smaller ones are manufactured from iron wire, formed by the aid of machinery, and japanned with a vitreous substance, which prevents them from rusting. The finest qualities are of brass, either washed or plated with gilt or silver. The reputation of some manufactures has added much to the sale of some wares of this kind.

S. H. Hartson, whose mechanical ingenuity has greatly improved the buckle, and for which he has secured a patent, has given a new impulse to the trade of small buckles in America. This beautiful mechanical device is in two parts, as usual, but the part called the tongue is extended through the other part of the frame, instead of merely resting its end thereon. It is estimated that one hundred tons of iron are annually consumed in the manufacture of these useful articles. The principal manufactories in this country are in Newark, N. J., Waterbury, Conn., and in the State prisons at Sing Sing and Auburn, N. Y.

---

*The New York Coach-Maker's Magazine.*

---

DECEMBER 1, 1859.

E. M. STRATTON, Editor.

---

## TO READERS AND CORRESPONDENTS.

**PUBLISHER'S NOTICE.**—*As the conductor of this Magazine is determined to make it as useful and interesting as possible, a general invitation is given to all in the different branches of the profession, to contribute to the different departments of the work, such improvements or new features as they may be cognizant of, anywhere in the United States, and when such matter is charged (if used) it will be liberally paid for. We hope that none will be deterred from writing or sending us sketches, under the impression that they cannot write well enough. We take it upon ourselves to properly see to that matter, under the conviction that the purest ore is often found imbedded in the most unsightly rubbish. The craft will much oblige us, if, when patentees call upon them, they would point out to them the superior advantages this work offers for placing their inventions before the craft.*

G. G. B. (WARRENTON).—Having neglected in your letter to mention your State, and the poverty of the post-office being so great as not to afford a stamp, the time and expense expended on your letter is thrown away. Try again.

L. K. L., of Columbus, O., writes us, that "It is said all around here that you have given up publishing the Magazine." Really that is news to us, which "our old friend" must have aided in circulating, because the report is so authentic, as usual with him.

C. H. C., of N. Y.—We wish you to understand distinctly that *ours* is a Magazine altogether independent of the one you refer to; consequently there has been no "changing hands" about the business. We are not willing to bear the imputation of ever being in any way connected in the proprietorship of a work that so ignobly discharged its duties.

## THEORY AND PRACTICE HARMONIZE.

VOLUMES have been written upon the subject of theory and practice, as though the one was entirely opposed to the other. In the commonly received acceptance of the word, the theoretical or speculative man is one whose mind is always soaring above the clouds, and building airy castles, with foundations as insecure as the baseless fabrics of visions generally are. On the contrary, the practical man takes matters as he finds them, studies their capabilities, and appropriates them to his use in the most practical form. He is very certain to be successful, because he never attempts any thing known to be impossible, and breathes only the air of reality; while his theoretical neighbor is so frequently soaring in the regions of dream, that he never realizes any thing but disappointment. But who shall say that both individuals are not acting out their appointed missions? Where the individual is possessed of the proper amount of theory and practice in combination, the benefit to himself and the world will be correspondingly great, as may be seen in many of the new inventions with which this age is daily startled. But let us consider the subject in a more extended sense.

The practical man, then, is one who, schooled in experience, undertakes only what is possible to be done. That which he has once accomplished, he contends, can be done a second time, and so he goes at it in great confidence, and consequently with corresponding success. He does not expect to leap from a parapet without being injured in the fall, nor does he expect any advantageous results to such an insane attempt. He expects, in every undertaking of his, to find, in the end, something of a beneficial nature, and hence acts with discretion, and exercises his judgment with a view to such results. He knows that should he wander into the regions of theory, he would be likely to receive disappointments, merely, as his reward. Consequently, he studies to make himself acquainted with cases, where they will, if pursued, be successful, and not trust to blind chance for his guide. His practical nature leads him to sure conclusions and beneficial results. His experience thereafter but serves to strengthen them the more strongly. Not that he treats every theory with contempt, for his practical nature enables him to reduce the theorems of others to practice—to distinguish between the possible and the impossible—that which is probable and the improbable.

The theoretical man, unlike the practical, is constantly breathing an air of speculation. His highest flights of mind very seldom bring any thing into his store-house. He is, in certain cases, the pioneer in pointing out the road for the matter-of-fact, the practical man, to follow; the sower of seed from which the practical husbandman reaps a plentiful harvest; the genius, for any one to profit from who wills.

Having thus spoken of theoretical and practical men, let us examine the subject connectively, and we shall discover that theory is at the very foundation of all practice: that it is erroneous to set practice in opposition to theory, as is done generally by mankind. It would be a very easy task to prove that every man, in most of his actions, is solving the problem of some theory, either good or bad. These being the facts, it is very important to find out which is the right and which the wrong—to be able to distinguish between them is an important point gained. There are many theories which, although they may be good, yet can have but little relation to the concerns of life; while there are others which have a close connection with the happiness of the race of mankind. It is this latter class of theories that most concerns us, and their importance will be in proportion to the sequences which follow, and influence the operations of our lives. There are some theories which, though correct as far as they go, express but a limited sequence of events; while there are others which extend much further, and comprise a much greater number of facts. Of course, this latter class of theories is the most valuable. Let us illustrate this from certain theories in nature—that of gravitation. It has been observed from time immemorial that bodies, left free to move, descend or fall to the earth, and this continued observation has served to change the mere theory into certain well-understood laws—that the tendencies of bodies to fall are as the squares of their distances. In this example we see that theory, followed out with practical observations, has demonstrated practical results. This shows that sound theories have laid the foundation for sound practice, and is sufficient to show that it is folly to place theory and practice in antagonism to each other. It has become a very common practice with some to sneer at the theoretical man, solely because they are differently constituted from him. This class of scorners are generally very wise in their own estimation, and think themselves very fortunate that they have opened their eyes with a very practical turn of mind. For the benefit of such, we will give a quotation from a distinguished writer. He says: "While it may be readily admitted that abstract science is useless if not combined with good sense and experience, yet the converse of this proposition is at least as correct, if not more so; it may, in fact, be affirmed, that no good public work can be safely intrusted to practical men, however great their ability, if they are deficient in a sound knowledge of mechanical principles and their application." A philosopher of earlier times declares: "That is not an art, but mere skill, which cannot give any account of the nature of the things it employs, nor explain the causes of the effects it produces. I do not give the name of art to that which cannot render a reason for what it enjoins." This subject is worthy of a more lengthened article, did

our space allow; but we think we have said enough to show that theory and practice are both necessary to produce good results, and that they should go hand in hand in all great undertakings.

#### FAIR OF THE AMERICAN INSTITUTE.

THE Thirty-first Annual Fair of the American Institute was appropriately opened to the public at Palace Garden, in Fourteenth street, in the city of New York, on the evening of the 16th of October, and closed rather suddenly on the 29th of the same month, hastened by the fall of snow on the previous Wednesday evening, which by its superincumbent weight caused the tent stretched across the open space to give way, thereby exposing the articles there arranged to the damaging effects of the elements. This misfortune has no doubt been realized in summing up the profits of this Fair.

Although there was a fair variety of goods on exhibition this year, still, in some kinds there was a discouraging deficiency when compared with some former displays. This was the case in the show of carriages, particularly. Of fine buggies, some half-a-dozen in all, and two or three business wagons, comprised the whole number. Probably the serious losses sustained by some parties at the Fair last year, had the effect of keeping the fraternity away this year.

The parts relating to carriages, designated as improvements, were also very limited. Brady's elliptical carriage spring, described on page 133, and which a cotemporary says, promises to be a valuable improvement, was among the most novel. We also saw there, for the first time, Thomas Bell's patent spring-brace, for which he claims great usefulness. He tells us that "the object of this brace is to prevent the bodies of wagons from lurching forward when the wheels meet with obstructions, thereby preserving the springs for a much longer period than usual, and permitting them in all cases, when the vehicle is passing over obstructions, either loaded or unloaded, to descend vertically." We are not going to dispute the efficiency of this contrivance, but a glance at the model is not calculated to impress the mind of a mechanic with the inventor's views.

Among the exhibitors of bent stuffs for coach-makers' use, we found our enterprising friend, Mr. Isaac B. Kilburn, of Newark, N. J. We saw among his collection of felloes, shafts, poles, &c., some of the best timber ever supplied by any one in his line of business. [See his advertisement in another department of this work.]

The Ives and Pardee Manufacturing Company, of Mount Carmel, Conn., had on exhibition a fine collection of their productions, among which were seventy different kinds of carriage bands, from one and a half inches to five in diameter, open and close, full plated and galvanized; eight

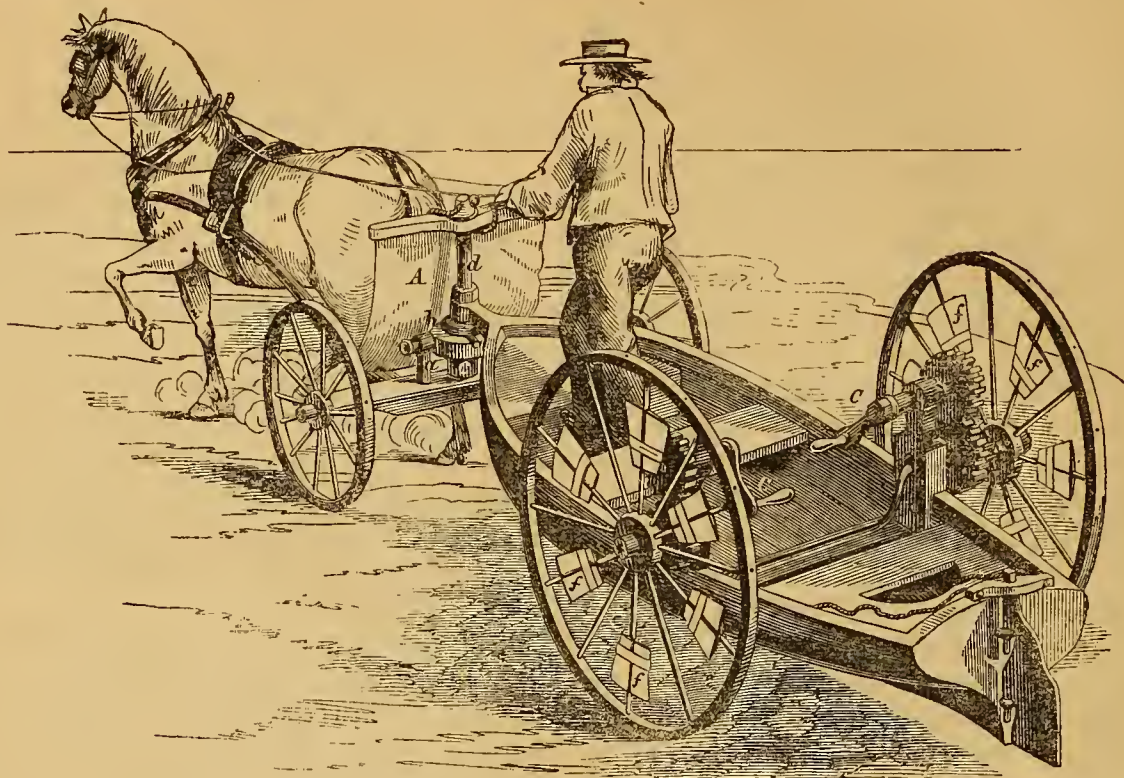

PERRY DAVIS' BUGGY-BOAT.

sizes of shaft-tips, from three fourths to one and a half inches, with an interesting variety of pole sockets, top-props, slat-irons, door-handles, plated nuts, and harness-fixtures, &c. Some of these were extra heavy in plate, and all apparently well got up.

In addition to the before-mentioned articles, not the least novel and curious was the recently patented invention of Mr. Perry Davis, of Providence, R. I.—the buggy-boat, an illustration of which, we are happy to be able to give above.

The inventor seems to have had in view the convenience of emigrants to the outskirts of civilization, where bridges are not yet known, and the benefits of those who delight in piscatorial enjoyments, who, in an extensive country, are not a few. How would the heart of old Izaak Walton have rejoiced in the addition of this buggy-boat to his other "fixins" upon the banks of the Thames! As may be seen in the engraving, this boat is suspended upon four wheels, more directly beneath the back axle-tree, the bow being attached to the front one by a sort of king-bolt, of a unique description. At *a* is shown one of two standards above the axle-tree, through which the trunnions of the hoops, *b*, pass, so as to maintain it in its place, in a level position, when the shafts are dropped. A short cylinder at *c* is dropped into the hoop, *b*, the cylinder being strengthened by two pins, one on each side, which fall into notches on the upper side of the hoop, supporting the cylinders. At *d* is shown the upper portion of the "king-bolt" or upright pin, which, passing through the front pad of the boat, and down through the cylinder, *c*, connects the

buggy-boat with the front axle. Between the top of the cylinder and the shoulder of the pin is inserted a piece of India rubber, which serves as a spring. The back springs are likewise of the same material. *A* is a screen hung in front of the buggy, to serve the purposes of a dash-board.

To the alternate spokes of the hind wheels are fastened the paddles, *f*, made from two pieces of wood fitted each side of a spoke, and secured in their places by iron bands. These paddles are turned in the plane of the wheel for land movements, and across the wheels, where they serve as oars in crossing rivers, on turning the wheels of the cranks, *C C*. The pinions to the wheels are so arranged as to be readily thrown out of gear when used as a traveling carriage, so as not to incommode the passenger—which would be the ease were they still permitted to revolve with the wheels—and to allow the boat to rest upon the India-rubber springs, above the axle, which it would not do without such an arrangement. Where the axles of these pinions pass through the standards in which they turn, grooves are cut around the axles, into which are fastened two thumb-screws, to hold the pinions in their places. When used on land these thumb-screws are taken out and shipped in the body, or boat, so as to be out of the way.

These, with an article professing to revive patent leather, and useful to carriage-makers, should it perform half that which is promised, will complete the sum total of all that we could see of interest in the carriage-making line, and justifies us in saying that this Fair was very poorly patronized by the craft—not at all to be compared with former exhibitions.



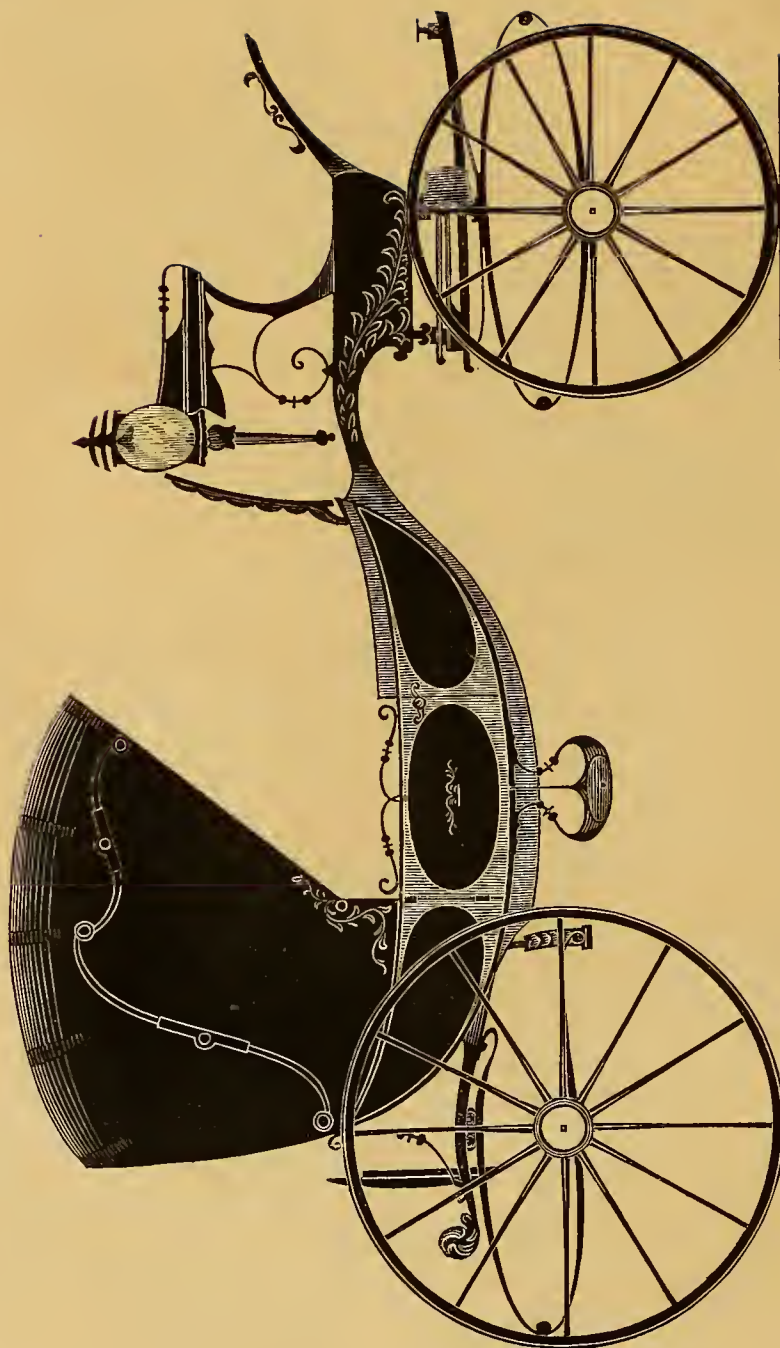

REPUBLICAN BRETT.— $\frac{1}{2}$  IN. SCALE.

Engraved expressly for the *New York Coach-Maker's Magazine*.—Explained on page 150.



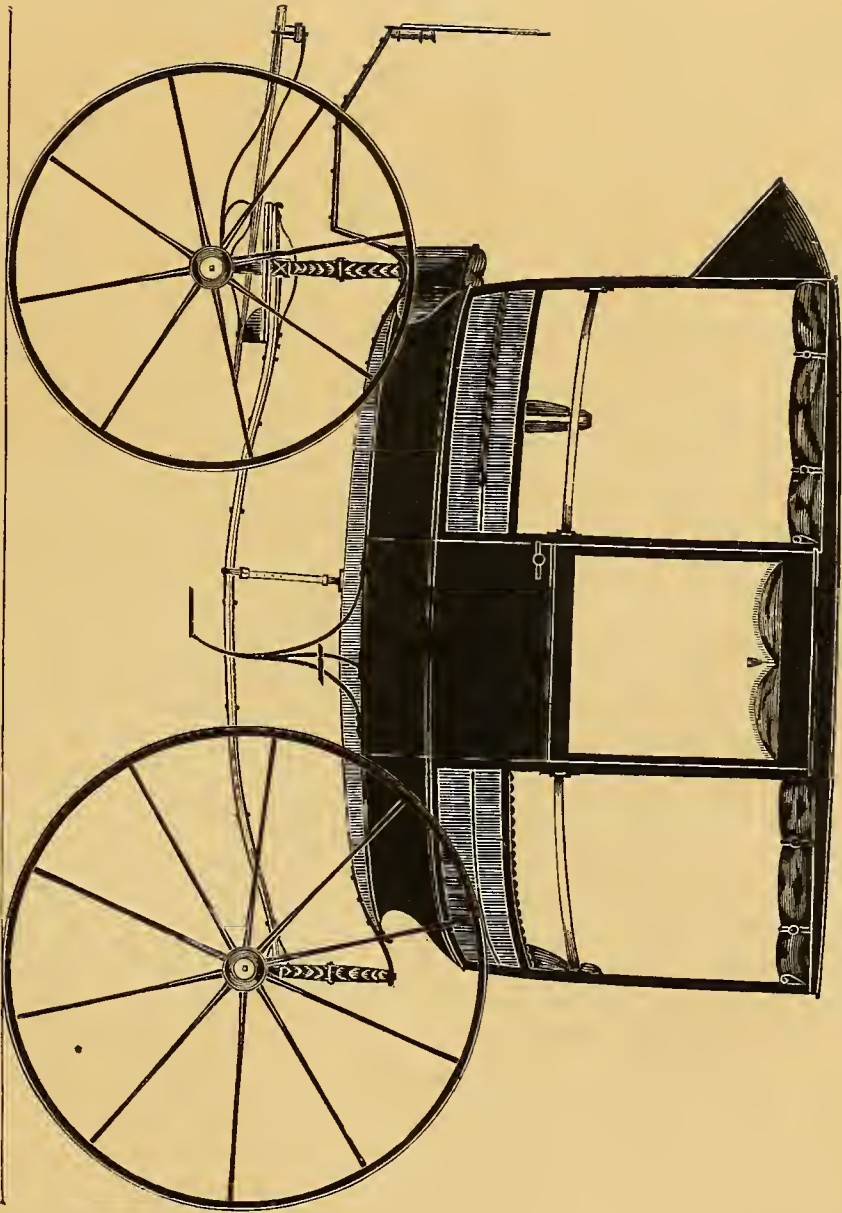

SIX-SEATED GERMANTOWN ROCKAWAY. —  $\frac{1}{2}$  IN. SCALE.  
*Engraved expressly for the New York Coach-Maker's Magazine — Explained on page 150.*



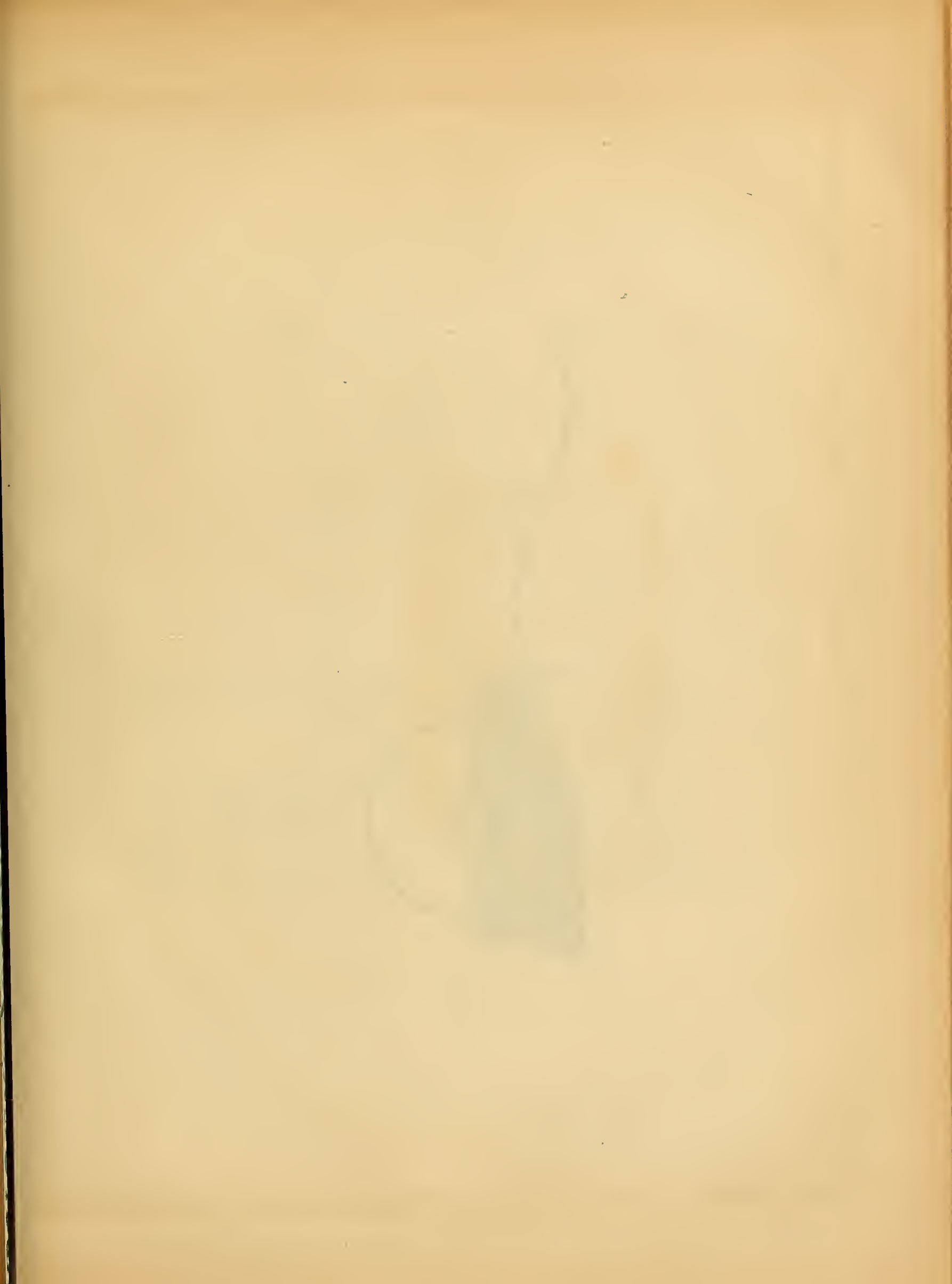

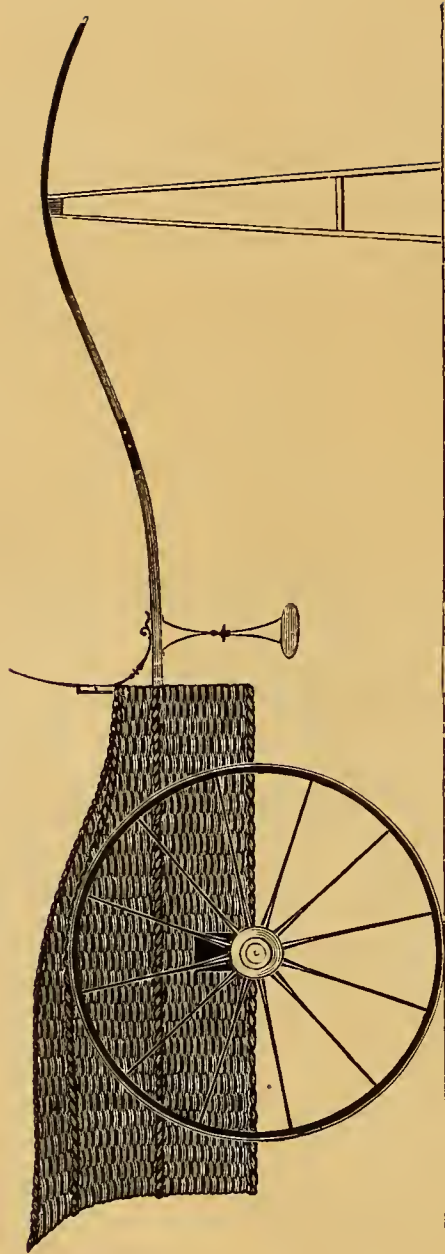

THE OSIER CAB.— $\frac{1}{2}$  IN. SCALE.

*Engraved expressly for the New York Coach-Maker's Magazine.—Explained on page 150.*

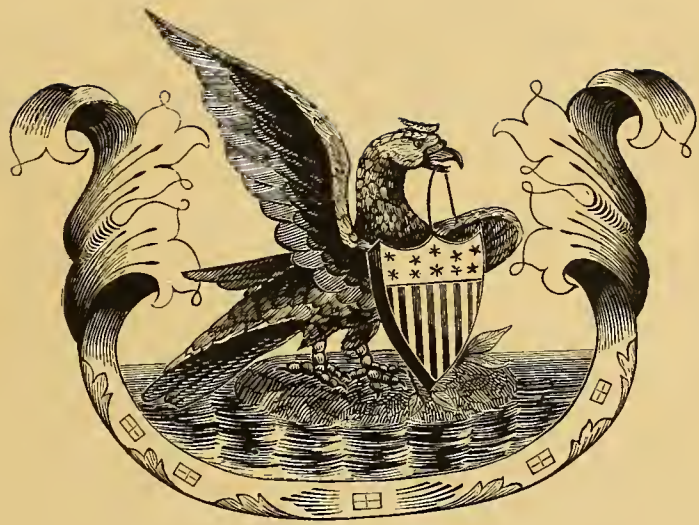

No. 1.

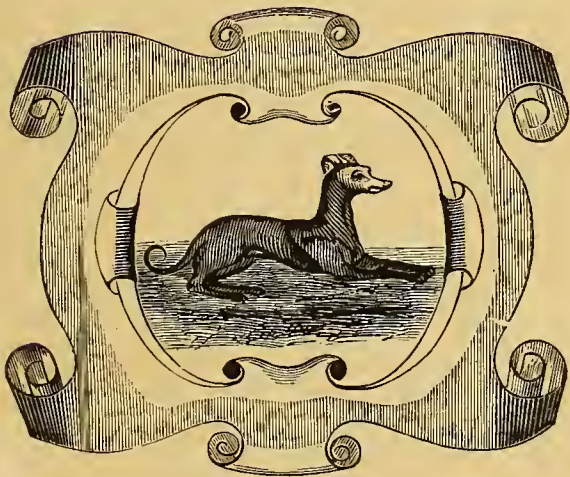

No. 2.



No. 3.

ORIGINAL ORNAMENTAL DESIGNS.

*Engraved expressly for the New York Coach-Maker's Magazine.—Explained on page 153.*





DEVOTED TO THE LITERARY, SOCIAL, AND MECHANICAL INTERESTS OF THE CRAFT.

Vol. II.

NEW YORK, JANUARY, 1860.

No. 8.

## Miscellaneous Literature.

For the New York Coach-maker's Magazine.

### THE AUTOBIOGRAPHY OF CALEB SNUG, OF SNUGTOWN, CARRIAGE-MAKER.

#### CHAPTER VI.

Caleb sees a ghost—The party at Cross-highway, and what followed it—Gig-shafts *sawed out* with a hatchet—Mr. "Considerable," a trimmer from Gotham—He goes to sleep a white man, and awakes of another color—Rolling food displeases him—An episode in Mr. Flatt's history personally related.

AFTER reading the letter given in the last chapter, I could not do otherwise than resolve on visiting home that same evening, after the day's work was over. Once more among my cherished kindred, with reminiscences of the past running through my mind, and engaged in agreeable conversation, the hours had fled away imperceptibly, when suddenly my attention was aroused by the loud striking of the old familiar clock, standing in the corner of the room; it was ten o'clock in the evening. I should not have thought of returning to Sawgetup on that evening, except it had been a beautiful moonlight night. Contrary to the urgent entreaties of the old folks, I felt obliged to go back, so as to be ready for labor the next morning early, although the early belief in, and recital of witch-stories by my credulous but inconsiderate mother, had fitted my prepared mind for almost any fears, especially should I be from necessity compelled to pass along uninhabited districts of road at late hours of the night. I had scarcely gone half the distance of my journey before fear began heavily to crowd into my mind, when all of a sudden, notwithstanding my firm determination to entertain no fears of any thing, on setting out, I was startled by a rustling among some leaves in the shadow of the stone wall which skirted the road, collected there by the autumnal winds. I felt every hair in my head bristling up, when, on casting my eyes in the direction, I saw some object, apparently of a dark color, slightly spotted with white, moving about. My first thoughts were to run, but then, how could I escape by that means? A moment's reflection settled in my mind a determination to face "the ghost" at all hazards. Deliberately approaching the spot, I startled a—what do you suppose, reader?—a big spotted hog, who in turn had now become frightened,

and ran away with a tremendous grunt, as fast as his four legs could carry him. Do you doubt it—*I have never believed in witches* (except biped ones) *since that night*. Could one always muster courage enough to investigate matters as I did on this occasion, all the belief in witches, now entertained by the uneducated classes, would soon die out.

The "carriage-making boys" at Sawgetup, taken all together, were about as likely a set of fellows as can generally be "scared up," in any "one-horse town" in Yankee-land. This being the fact, we were frequently invited to "kissing parties," and on some occasions the scene of operations was distant from Sawgetup some three miles. I very seldom honored these "invites," and six months in the year close confinement to the work-bench precluded the very thought of any such "indulgence," in us all. Still, early in the fall and spring, such "amusements" were not altogether neglected, and on one occasion our whole crew turned out, and, as Burns has it, we staid

"Some wee short hours ayont the twal."

"This gathering" of country "lads and lasses," had in its composition some originals, and the fun was prolonged until midnight, when a thunder-shower having burst over that locality, those who had come from a distance were compelled to remain at Cross-highway until the rain should be over, or else run the risk of getting *sponged*. Day having dawned after a sleepless night, after all, as the rain had not wholly ceased, we were compelled by necessity to run the gauntlet of the storm, and besides getting wet to the skin, subjected ourselves to the severest censure of the "old boss," who declared that "kissing and watching all night was not calculated to prepare us for an extra day's labor on the following day." I have never questioned his judgment in this matter. Flatt's Hall the next day presented very much the appearance of the Jews' quarter in Chatham street, on a Sunday morning—old clothes hanging out to dry! Mrs. Flatt in her tantrums!

There will, generally, among boys—sometimes of the larger growth—be found some of an impulsive and rash nature. Of this disposition was William P., a fellow apprentice. At the time to which I refer, gigs were the most fashionable vehicles then in use, and he was set to sawing out and making a gig-carriage-part; but finding his saw not exactly in as good condition as it might be, and not just

then being in a mood for filing it, seizing a hatchet, he struck it furiously into the saw-calf, already extending fully one-half the length of the shaft. The consequences were that he spoiled two shafts already marked out on a plank. Just at the moment, the "old boss" came in. The storm of censure he poured out upon that "careless fellow's" head was truly "a caution." It sent him out of the shop *instantly*.

I did not know how this matter would end, but after a day or two this storm blew over; but "Who split out gig-shafts for Mr. Flatt?" was a question he did not hear the last of for many weeks.

Soon after this, the senior boss again visited New York City—which, as was his custom, he did tri-monthly—with his manufactures for Mr. Wagonseller, and on his return he brought with him a "New York trimmer," who was in person the most singular genius I ever met with. On account of his habit in conversation, of frequently using the word "considerable" he very soon became known about the village as Mr. Considerable. Under this soubriquet, then, I here introduce him to the reader.

Our Mr. Considerable was very fond of telling stories, which he was qualified to do successfully to a country audience, by a long residence in the city of New York, and besides he was an adept at cutting what he took pleasure in calling "a pigeon-wing." This practice of relating stories and dancing for the amusement of the villagers and hangers-on about "the stores," and for which he was generally paid *in a horn*, kept him "fuddled" full one half of the time. As is very often the case, he was a first-rate trimmer for that day when he could be caught sober, but with much trouble and difficulty the Sawgetup firm could barely get three days' work done in a week. No respectable shop at the present day would tolerate such conduct in an individual even for two days, but at the time of which I am writing, it was very difficult to get trimmers at all. In consequence of the *weakness* of our new shopmate, after forbidding the shopkeepers from furnishing "the spirit," the junior partner resorted to the expedient of doling out his rations, stately, from a stone-jug that he kept locked up in a chest in the shop. For this indulgence in the "critter," Mr. Considerable had to foot the bill, but it was charged by the boys that the dealer-out took the larger portion as toll for his trouble.

Notwithstanding these precautions, Mr. Considerable still found "the ardent," and would "*get excited*," and frequently lay down and slept in the shop; the consequences were, that on awakening he would either find himself fastened down to his work-bench by having a side of leather nailed over him, or fastened by a cord, hand and foot, or else with his face painted black, or in some other fix. With his *low* habits, he had some *high* notions of his respectability. These two combinations placed him on one occasion in a ludicrous predicament, in which his shopmates had

no hand. He had gone to the only hotel in the village, across the bridge, and with another "hail-fellow-well-met" imbibed too freely; the two afterwards retiring to an adjoining hay-mow in a barn, to sleep it off. Some mischievous fellow, ripe for fun—of which enough can at any time be found in a country village—having discovered the brace and procured a brush and some black paint, proceeded successfully to give an ebony cast to the countenances of both. No individual of "a darky band" ever presented a more faithful resemblance of a descendant of Ham, than did these unfortunates. Mr. Considerable returning to consciousness first, and observing by his side what he took to be a "gemman ob color," gave vent to his indignation by planting his mallet on his companion's proboscis, which awoke him instantly, *if not sooner*. "Gaw hang," he vociferated, "you black rascal, what are you doing here? Get out; you must have *considerable* impudence, you black, dirty, low-bred ape, to intrude yourself into a gentleman's company!" By this time the stranger's optics were open far enough to discover that Mr. Considerable's face was as black as his own was declared to be. "Why," said he "*you are as black as I*



am!" Here was a pretty picture indeed. Two white *gentlemen* having lain down just to take a nap, on awakening found that, chameleon-like, both had turned Africans!

Finally the patience of the bosses became exhausted with the New Yorker, and what to do was a difficult matter to decide. Some suggested one thing and some another. Mr. Towner, as a final effort, decided to try and cure Mr. Considerable of his bad habit. Having heard that by putting a live eel into the liquor it would cause sickness in the consumer, so as to effectually cure him of his habit of drinking, I was sent at low tide to hunt for the remedy among the rocks under the Sawgetup bridge. Being successful the experiment was tried. The poor fellow *was* sick after taking "his horn." He did not taste the "critter" for three days thereafter, saying, *he believed the pork he ate for dinner had made him very sick*. But, as to curing him effectually, that in his case was a hopeless task, for the fellow got "gloriously" drunk in less than a week afterwards.



Mr. Flatt never let any opportunity slip, without improving it to his own advantage. At the table he would frequently say, "The boy that eats fast will naturally work fast. It is a sign I never knew to fail." This sentiment was so frequently presented to us, and so well understood to be an incentive to quick eating on our part, that we very soon could dispute with the most greedy animal, in dispatching our food. If Mr. Flatt's argument is true, as a consequence his boys *ought to be* the fastest workmen in America. This dispatch in "punishing food," was very annoying to our Mr. Considerable, and he declared, he believed that if he were to stub his toes and fall, on his way to dinner, that he might as well go back to the shop, for, said he, "*There would be nothing left for me to eat.*"

If there was any subject on which Mr. Flatt loved to declaim in our presence more than another, it was the necessity of employers treating their employes with as good an article of food as themselves partook of. The following incident in his history, he used to relate to us, at the table, with evident satisfaction to himself. We used to hear the story so often, that I got it fixed in my memory. "Mr. A. once called upon me," said Mr. Flatt, "saying that he had a very fine and fat steer he wanted to dispose of, and knowing that I had a very large family of apprentices to feed, he thought it very probable that I would purchase. I told him I wished to buy, but that I would have no other than the first quality. He replied, he had just what I wanted, and immediately invited me to jump into his wagon, and go and look at the animal for myself. I did so; but, when I came in sight of the field where *the steer* was pastured, I found a poor and miserable *old ox*, tough enough to break the teeth of the eater. Said I, 'Is that the animal?' 'Yes,' said he. 'Oh!' said I, 'that is not the animal I want.' 'Oh!' said he, 'that is good enough for apprentices.'" Said Mr. F., "That hurt my feelings, and I left him immediately, because I am determined that my hands shall fare as well as their boss." That story always made us laugh—in *the sleeve*.

For the New York Coach-maker's Magazine.

### HOW WE PASS AWAY!

BY S. EDWARDS TODD, ESQ.

"WHEN I remember all  
The friends so linked together,  
I've seen around me fall,  
Like leaves in wintry weather,  
I feel like one who treads alone,  
Some banquet-hall deserted,  
Whose lights are fled, whose garlands dead,  
And all but he departed."

WHAT a vast throng would encircle me, were the children, and youth, and those in the prime of manhood, who commenced their career in life with me, to come forth from the mansions of the departed, and be endowed with life, as they once were! How many have passed away! How rapidly they continue to do so! When my mind runs back for thirty years, and I call to remembrance the names of those who were my friends, and companions, and associates in more matured years, and I find that such a large proportion of them have passed away, I seem like one who has escaped as the only survivor of a large army, which has been cut down and slaughtered by a relentless foe. Their names are almost effaced from the tablet of memory!

How soon I shall pass away likewise! How soon will the day dawn, when I shall pass, for the last time, my own

domestic threshold, and be laid down in silence, and alone, in the darkness of the gloomy grave! How soon will others sit in my place, and look out on the fields and scenery which I now behold! How soon my fruit-trees and shrubs, and other things around me, on which I have bestowed so much toil and care, and which have been such a source of comfort and pleasure to me, will receive the attention of those, who may be so destitute of a suitable appreciation of my labors, that in one day the fatal ax may sweep away what has cost me the incessant toil of half a lifetime to produce.

But, what matter is it, whether I be followed by a wise man or a fool; since, when I pass away, I hope to enjoy new scenes, infinitely more comfortable, pleasant, and delightful, and to companionize with those who never *think* ill of each other, and who never feel any resentment, calumny, or spite rising up in their guileless souls? Amid all the beauty, and grandeur, and magnificence which we meet in the natural world, and notwithstanding the tenacity with which we cling to the life which now is, and the gloom, and cold, silent night of the grave, who does not feel willing to *pass away* in the train of the countless throng, and mingle in the society of the pure and the good?

For the New York Coach-maker's Magazine.

### LINES TO MY JACK-PLANE.

BY C. THOMAS.

WELL, Jack, my lad, you're growing old,  
You bear the marks of age;  
Your story soon will all be told.  
But courage Jack! You long shall hold,  
A place on memory's page.

You've many a sad mark on your face,  
And bruise upon your front;  
But in life's crowding, struggling race—  
And ours has been no ambling pace—  
You've always borne the brunt.

We've had to "rough it," you and I:  
The work that we have done,  
Has worn us down a little, Jack;  
But those who follow in our track,  
May glide more smoothly on.

What though by contact with the world,  
In pushing on, my lad,  
You are so scarred and bruised and worn,  
And of your pristine beauty shorn:  
Should these thoughts make you sad?

'Tis only on the surface, Jack;  
You're sound and clean at heart:  
'Tis but the meaner sort of clay  
That time doth from us wear away,  
But leaves the better part.

Wouldst have thy shining youth again?  
Nay, nay! no more would I—  
We ask not time to lead us back,  
But stoutly marching forward, Jack,  
We'll grant to age no sigh.

Then push along, my worthy friend,  
While life spins out its thread:  
We ask not leave to rest and rust,  
Until is written, "Dust to dust,"  
Above our grass-grown bed!

WEST NEWBURY, Mass., Nov. 13th, 1859.

HE who labors for mankind, without a care for himself, has already begun his immortality.

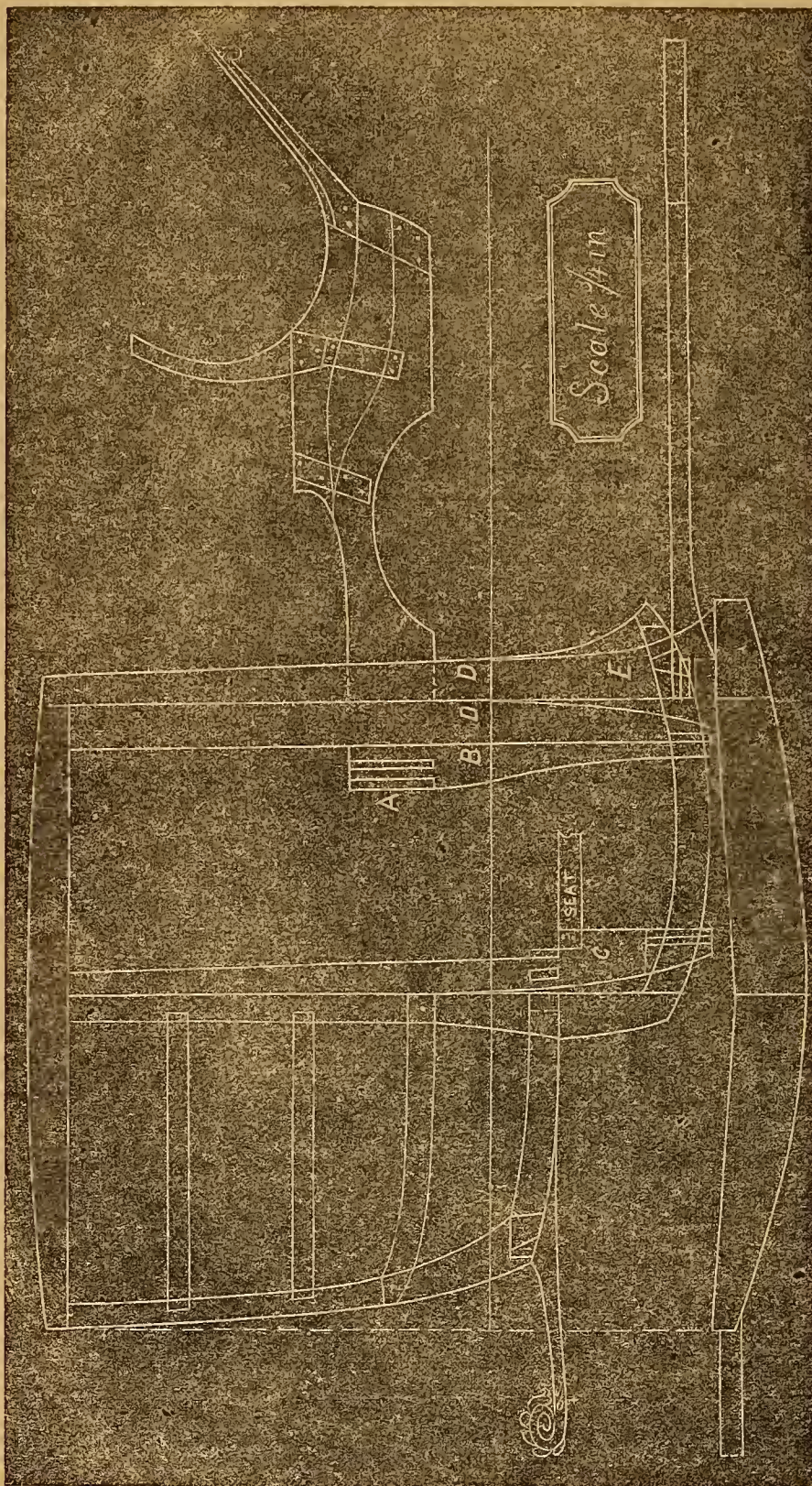

For the New York Coach maker's Magazine.

### GEOMETRY OF CARRIAGE ARCHITECTURE.

BY A PRACTICAL COACH-MAKER.

#### PART TENTH—BODY CONSTRUCTION.

ON Plate 30, vol. 1, this coupé will be found finished with a slight variation in the front boot; but the construction amounts to about the same thing. A, gives the section of the front boot-rocker, which is tenoned

and lapped into the filling piece, B. This piece is screwed on to the inside of the front-pillar, D. Its thickness must be regulated by the amount of concave required in the front. The object of filling-pieces is to level for the edge-plates, so as to avoid cranks on the flat of the iron; for wherever a body is made that the edge-plates have to be cranked to fit the corners, such a job is sure to be springy. As there is no rocker used in this kind of a body, the standing pillar, C, must be wide enough to fill out to the inside of the bottom-sides. It would be well to get the brake and bottom-side out in one piece, as there is a good deal of framing in the back corner with the back-pillar and bottom-bar. The curved line, E, represents the front bottom-bar, which must be concave, to make room for the front wheel in turning. There should not be an inch of room thrown away in hanging up a job of this kind. Concealed hinges should be used on a body of this description, and the doors hung on the front-pillar.

For the New York Coach-maker's Magazine.  
AN APPEAL TO WINTER.

BY JAMES SCOTT.

DREAD Winter! king of ice and snow,  
And all the elements of cold,  
A mortal claims a boon of thee—  
A mortal seeking aid—but, hold!

Into thine ear, O King! I'll pour  
The story of my sore distress;  
'Twill move thy heart, I trust, to grant  
My humble prayer: it can't do less.

Whene'er on earth thou deign'st to reign,  
I meekly own thy sovereign sway,  
Nor murmur at the dreary snows,  
E'en though they come in flowery May.

The cutting winds, the biting frost,  
May chill me through, or freeze my toes,  
Ay! even turn my breath to ice;  
But oh! in mercy, spare my nose.

Nor sling, nor punch, nor "whisky straight,"  
E'er fires my blood or turns my head;  
And yet folks say 'tis drinking hard  
That makes my nose so awful red.

Thou knowest 'tis a slanderous tale;  
'Tis cold, not grog, that tints my nose:  
Then spare it, King of ice and snow,  
Oh! spare it when the north wind blows.

THE DISGUSTED COOPER.—The customers of a country cooper caused him a vast deal of vexation by their saving habits, and persistence in getting all their old tubs and casks repaired, and ordering but little new work. "I stood it, however," said he, "until one day old Sam Crabtree brought in an old bung-hole, to which he said he wanted a new barrel made. Then I quitted the business in disgust."

### PURITY OF TASTE AS APPLIED TO CARRIAGE-BUILDING.

"TASTE" has been defined as "the perception or power of perceiving and relishing excellence; the faculty of discovering beauty, order, congruity, proportion, and symmetry." It is, however, more than this, and of far too aerial and mystical a character to be thus limited; in fact, it cannot be chained down to a definition, or bound too rigidly by a rule. It is, nevertheless, governed, in common with our other faculties, by certain fixed principles and unerring laws; otherwise it would degenerate into caprice, or sink into the affectation, the whim, or the fancy of the individual. It is very commonly presumed that what is generally called "good taste" is an intuition—inherent with some, denied to others. This is evidently a mistake. It is neither the gift of nature nor the result of art. No doubt it is a fact, that the naturally perceptive mind, keenly alive to all the beautiful and true that surrounds it, intuitively imbibes much that forms the judgment and refines the feelings. The imagination comes into play with all its various associations, the emotions become excited, and all the finer qualities of our nature are pleased. This, however, is but part of the process; the education and cultivation of these faculties are as essential as their original possession; things of different degrees of excellence require to be compared and balanced, the coarse and the impure to be eradicated, the gold refined from the dross. With some, it is a long and tedious matter; with others, more quickly attained; but in no case is there a royal road, or maturity reached by a bound. It follows then, that it is a predisposed tendency of the mind united to a patient cultivation of those faculties that bear upon excellence in art, form, fabric, or color—that makes the quality usually recognized as good taste.

"Good taste" must, however, be invariably distinguished from mere "fashion," although they frequently go hand-in-hand. Fashion is said to be the greatest tyrant that ever ruled mankind. Its influence in producing so frequent revolutions in the sentiments of men with regard to the beauty of those objects to which it extends, and in disposing us to neglect or to despise at one time the object we considered as beautiful before, may, perhaps, be explained only on the principle of novelty. Fashion may be considered in general as the custom of the great. It is the dress, the furniture, the manners of the great world which constitute what is called fashion in each of these articles, and which the rest of mankind are in such haste to adopt after their example.

Whatever the real beauty or propriety of these may be, it is not in this light that we consider them. They are the signs of that elegance, ease, and splendor, which are so liberally attributed to elevated rank; they are associated with the consequence which such situations bestow; and they establish a kind of external distinction between this envied station and those humbler and more ordinary conditions to which no man willingly belongs. It is in the light of this connection only that we are disposed to consider them, and they accordingly affect us with the same emotions of delight which we receive from the consideration of taste and elegance in more permanent instances. As soon, however, as this association is weakened; as soon as the caprice or the inconstancy of the acknowledged leaders has introduced other forms, colors, or usages in their place; our opinion of their beauty is immediately destroyed. The quality which was formerly so pleasing or

so interesting in them, is now transferred to other objects, and our admiration is as readily enchained by those newer forms which have risen into distinction from the same cause. The forsaken fashion, whatever may be its real or intrinsic beauty, falls, for the present at least, into neglect or contempt; because either our admiration of it was founded only upon that quality which it has lost, or because it has descended to the inferior ranks, and is then associated with meanness and vulgarity. A few years bring round the same fashion. Novelty again asserts its sway, the same associations attend it, and our admiration is excited as before.

It will readily be seen, from the above considerations, that the quality known as good taste rests on other foundations than its neighbor, fashion; and that only those who can perceive and appreciate the "pure," the "beautiful," and the "true," in the common, every-day experiences of life, can lay claim to it.

The design, construction, and decoration of CARRIAGES OF LUXURY differ in various countries, according to their individual national characters. For instance: while our neighbors, the French, admire display and elaborate ornamentation, our cousins across the Atlantic pay chief attention to mechanical construction. The happy "mean" appears to be with the English builders, who, while devoting much attention to effective construction and simple elegance of outline, make all ornament subservient to general utility. Avoiding details, it would appear that in the design, construction, colors, and appointments of carriages, certain fundamental rules may be laid down.

In every case, *fitness*, or adaptability of the carriage to the purpose for which it is required, should be the first consideration; without this, whatever may be its beauties of form or harmony of colors, it must result in a failure.

*Simplicity of construction*, with thorough effectiveness and quiet elegance of outline, is the next great point.

*Individuity of character* is most important, not only in the *tout ensemble*, but in all matters of detail: "*quisquid in suo genere satis effectum est valet.*"—*Quinct. xii. 9.*

*Due proportions*, free from exaggeration, and independent of any passing style and mannerism, are most essential. The employment of material, however plain and simple, *the best of its kind*, carefully selected, and adapted by its peculiar quality to the particular requirements of the case; this, as a matter of course, must be united to excellence of workmanship.

Except in carriages built expressly for display, a *subdued style of painting* is most permanently pleasing, and the avoidance of any thing *outré* in all decorations and appointments should be studied; thus forming a certain harmonious combination which, without attracting attention to any one part, pleases and gives satisfaction as a whole.

These remarks will appear as "truisms" to many; nevertheless, carriages thus built, whatever may be their defects or degrees of excellence, will always be admired for the "purity of taste" displayed in their construction.—*The Carriage-Builders' Art Journal.*

EARLY USE OF CARRIAGE SPRINGS.—In 1744 light-bodied chariots were advertised in London, "fit either for town or country," carriages on springs beginning then to supersede the wagon-like coaches of former days.—*Note to Lady Hervey's Letters, p. 57.*

COACH-MAKING HISTORICALLY CONSIDERED  
AND INCIDENTALLY ILLUSTRATED.

BY THE EDITOR.

CHAPTER XVIII.

The condition of wheelwrights and coach-makers in a former day contrasted—Railways: how they have affected post-travelling in England—Very few of the first-class manufactures in London and Paris contributed to the Exhibition of 1855—The comparative excellence, from an English stand-point, between the English and French carriages—Napoleon III. a great patron of coach-making—The French exports to foreign countries.

In our last chapter we find that the *caste* of such as rode inside of post-coaches, and of those which rode outside, were vastly different. The same difference of respect was also entertained in regard to wheelwrights and coach-makers, as we find in a work entitled "The world runs on wheels," which, as it is curious, we give here. "A wheelwright, or a maker of carts, is an ancient, a profitable, and a trade which by no means can be wanted [dispensed with]; yet so poor it is, that scarce the best amongst them can hardly ever attain to better than a calves'-skin suit, or a piece of neck-beef and carrot-roots to dinner on a Sunday; nor scarcely any of them is ever mounted to any office above the degree of a scavenger, or a tything-man at the most. On the contrary, your coach-maker's trade is the most gainfullest about the town. They are apparelled in satins and velvets—are masters of their parish—vestrymen who fare like the Emperors Heliogabalus or Sardanapalus, seldom without their mackroones, parmisanis, jellies, and kickshaws, with baked swans, pastries hot, or cold red-deer pies, which they have from their debtors' worships in the country." Such a picture of the "easy times" of our fraternity at the time of which our history treats, is sufficient to cause regret on the part of those in the business at the present day, that they did not live a hundred years earlier.

We have thus far treated of carriage-making in the old world without entering into contrast. We are happily provided with this already to our hand, as regards England and France, in the report of Mr. George N. Hooper, on the carriage department of the Paris Exhibition of 1855, read before the London Society of Arts, in December of the same year, from which we make the following extracts:

It may be remarked, in examining the carriage department of the Paris Exhibition, as of the Exhibitions of London and Dublin, that none of them contained a single specimen of a posting traveling-carriage, such as before the construction of railways was as necessary a part of the establishment of a nobleman or rich landed proprietor, as was his service of plate or his valet. Traveling is so altered with the almost universal system of railways, that such carriages are now only retained by royal personages, and others of high rank. Railways have, however, in other ways affected the manufacture of carriages. Formerly it was of the utmost importance that a carriage should be very capacious, as journeys frequently occupied several days, and a frequent change of position, and room to sit comfortably, were essential to a snug journey. On account of their great size and the quantity of luggage they had to carry, it was also necessary to make them strong, not only to sustain the weight put on them, but to resist the shocks and concussions on bad roads. All classes being now conveyed by railway, renders such carriages

almost obsolete; in fact, they are only required for traveling in remote parts, where railways do not exist.

An omission in each of the Exhibitions has been the almost entire absence of public carriages for common roads; such carriages are still required where no railroads are made. It is true there are very few four-horse coaches, "the pride of the road," now running in England, but considering the high degree of perfection such conveyances had attained before the introduction of railroads in England, an example of one of them would have been worth sending to the Paris Exhibition, as not only in France, but in other countries of Europe, are the public conveyances, traveling distances fifty or more miles apart, still of the most cumbrous and clumsy construction. It may be said that for every two passengers conveyed by an English stage or mail coach, taking weight for weight, a French "diligence" or German "eilwagen" only carried one passenger, and that at little more than half the speed of our English coaches. Many continental roads are now as good as English roads, and foreigners may much increase the speed of traveling where railways are not yet made.

The public carriages for towns and cities are only represented by one omnibus. No Hansom's cab appears, nor does Paris show any of the little four-wheel phaetons now so numerous in the French capital. A London four-wheel cab would certainly not shine in such an assemblage, but a comparison of the public carriages of the great European capitals might have led to improvements in all.

Very few of the builders of the first class of carriages in London or Paris contribute to the present Exhibition. Were the system of prizes abolished, and the public left to form their own judgment of what was placed before them, they would probably come forward and materially raise the character of the productions sent to such Exhibitions. The award of a prize medal does little good to such houses as are already well established and doing a large trade, whereas the withholding one (either from the jurors being deceived by a novelty without utility, a "tour de force," or a display of profuse decoration) may do them an injury which they prefer not to risk.

The countries exhibiting are England and Scotland, France, Belgium, Hamburg, Austria and Lombardy, Sweden and Norway, Sardinia, Holland, Canada, Switzerland, and Mexico.

Those not represented are Prussia, Saxony, Hanover, Bavaria, Russia, Ireland, Spain, Portugal, Naples, the Roman States, and United States of America.

It may be safely said, that as far as the Exhibition represents the state of comparative excellence, England maintains her position for turning out soundly made and well-finished carriages; constructed so as to give comfortable accommodation to those who use them, and in such a manner that the proportions are well balanced; strength being applied to those parts where it is requisite, and unnecessary material and workmanship avoided where they can do no good. In a point where English carriage-builders might possibly have been expected to be somewhat behind, they still take the lead; the outline and proportions of their carriages are superior to the foreign ones. English coach-builders have maintained simplicity of outline with elegance, and have made their carriages for what they are intended, and not as specimens of what it is possible to accomplish. Many of the English exhibitors in this department are themselves practical draughtsmen, and have worked at the actual framing and making of

carriages, whereas the foreign builders, although in some instances good draughtsmen, have not worked at the actual framing and construction of carriages, but at the after-fitting of leather work and lining; these parts in consequence attract their chief attention.

France sends several well made carriages; the best are those made after English models; they are well proportioned, with good workmanship, avoiding useless labor and worthless decoration. Some excellent inclosures for converting open carriages into close ones are shown. Lille and Bordeaux follow closely on Paris in the quality of their carriages.

Among the French carriages a large proportion are mere "tours de force," only fit to be kept in a room. The decorations are almost their only feature (the two lamps on one carriage are said to have cost £80 sterling, and they are certainly very beautiful). Such carriages will probably be rewarded with a prize medal, from the mere amount of money spent on them; and almost any amount of decoration can be had in Paris, where money is forthcoming.

France also exhibits several plans for detaching runaway or fractious horses from carriages, but they all seem to have the objection, that the horses may become detached by accident, and probably cause the evil they are intended to avoid. It would be better for French drivers to attain greater perfection in their calling; they seem to drive in the most careless manner possible, almost invariably with loose reins, not keeping a sharp look-out in front, or on their own side of the road; it is not uncommon for the driver of a diligence to sit on the reins of the five horses he is driving, while with the whip in both hands he lashes his rough stallions, each in his turn, and in proportion to his merits. While such driving continues, accidents must be unavoidable.

The present Emperor has given a great stimulus to the building of carriages in France. Having resided so long in England, he has imbibed a taste for carriages and horses. Of the former he has had a very large number built since he has been in France; they are nearly all in the English style. His dress carriages are decorated with extreme richness. Giving a very large price for the best English horses, his equipages are such as are not to be equalled in appearance in any other capital. This has set a fashion in Paris for good carriages, and has of late years rendered the trade of coach-building in the French capital very flourishing.

Paris makes a number of carriages for foreign countries, chiefly Spain, Italy, North and South America, and Egypt; moderate duties, favorable to the French, and a liking of many foreigners for their rich silk linings and fittings, are probably the cause of this export trade.

The prices of the best French carriages are now about the same as the English. Their system of ready-money transactions with their customers facilitates their operations, and enables them with a moderate capital to carry on a good trade, whereas the long credit taken by many persons using carriages in England cripples the trade, and causes such persons to say that English carriages are expensive, whereas those who pay at once for what they buy, get their carriages quite as cheap, quality considered, as any foreign country can produce.

Hamburg shows a single carriage of excellent workmanship, though from its contrivance, it is not likely to be comfortable for those who use it.

## The Home Circle.

For the New York Coach-maker's Magazine.

### ALICE, THE MOSS-GATHERER.

BY LIA DELINN.

A CLUSTER of violets, springing, as it were, from a bank of moss, and the single word Alice, half hidden by one of the purple leaves, and further down on the page a half-unfolded rose-bud, all alone, as if to place it there had been an after-thought—that is the first page of my Herbarium. On the next—but it is of the memories clustering around that penciled name, among the violets which Alice so tastefully arranged, and upon that bud which my hand long afterward placed there, that I would speak now. Perhaps, another day, we will turn to the other pages.

"My dear, this would do very well for a frontispiece, but I am sorry that you so far forget the design of an herbarium as to convert yours into a mere receptacle for mementoes of friendships which *may* last till your school-days are numbered, but which you will never afterwards care to recall."

"Why, Miss Frankland! You don't know me if you think me so fickle, or that my friendships are thus lightly chosen. What would I care for the book if these flowers were not the offerings of friends, and if their names had been omitted to give place to a long list of Classics, and Orders, and unpronounceable scientific names?"

"We will not discuss the question. Wait until you leave school; then, if you are not disappointed in every one of your intense friendships, I should be glad to know it."

Not long afterward, a leaf of *nightshade* and my teacher's name were placed side by side on one of the unoccupied pages, and my Herbarium was laid carefully aside for future reference.

My friendships, as I boasted, were not hastily formed, and yet Alice Irwin and I were friends from the morning when we entered the school-room as strangers to each other and to the pupils already there. Before the day was over, Alice was acquainted with all of her new associates, and in less than a fortnight, was beloved by all: but when weeks had passed, I was still a stranger to many of them. In course of time, however, a goodly number became my friends, and then we wondered why we could not sooner have brought about so desirable a result, and what it was that made *Alice* a universal favorite. She was not beautiful, like Kate Murray, nor witty, like Nellie Scott, nor did she dress elegantly, like Sarah Bennett. Others were amiable and loving, as prompt in recitation and as active in recreation hours as she. What was the charm? We finally concluded it was because she was always so *happy* that she drew all hearts after her; but then, what made her so happy? Her tasks were the same as ours, and sometimes she failed in them as well as we; but that never troubled her—she would study harder next time, and do better. If the lessons were harder than usual, she was the first to discover that they were unusually short. In pleasant weather she would congratulate us all that it was so bright and cheerful, and when it rained, because we wouldn't be troubled with visitors. However untoward any circumstance seemed to

us, it was sure to have a bright side for her; and however disagreeable any one of the teachers or scholars might be, Alice was certain to find something attractive in that individual. One day a new scholar came among us—the most uncouth figure, Kate Murray said, that any one ever saw. Judging from her size and stature, she might be twelve years old, while her little, pinched, sallow face looked all of thirty. Her head was small, even in proportion to her size, and she wore her hair stretched straight back from her forehead, and screwed up into a small knot which was fastened on to the top by a large comb. Her eyes, which were rusty brown, took up such an undue share of her face as to make the other features seem of minor importance. Her dress had evidently been made without reference to any pattern, and though sadly faded, still retained some half-dozen different colors. Around her waist a long, narrow check apron was fastened with tape-strings, and instead of a collar, a colored cotton handkerchief was pinned about her neck. It is embarrassing to any one to be obliged to face the staring, wondering, quizzing eyes of a roomful of giddy school-girls, and the new scholar seemed painfully conscious of her position. Kate Murray was requested to conduct Miss Hill, the stranger, to Miss Frankland's room, but Kate turned such an appealing glance on the teacher, and then such a look of dismay, first on the stranger and then on us all, that it was too much for our gravity to withstand. Alice's face was the only one that wore its usual expression, and she was apparently so busy with her lessons as not to have seen what was going on. The stranger had seen it all. Her great brown eyes lost their faded look—for a moment they were fixed wonderingly on Alice's face, then they fastened on me with a look of hate, and then went darting from one to another, leaving a defiance with every glance.

When recess came I hastened to her side, hoping by the kindness of my manner to remove the impression made by my thoughtlessness in the morning, but the look of hate she flashed upon me was my only reward, and I left her in disgust. She entered all my classes, and we were often thrown together, but I would not renew my attempt at an acquaintance with her. All the school, except Alice Irwin, either openly avoided her, and treated her with cold civility, which was thrown away, for she seemed to have become utterly unconscious of any presence but her own. In course of time she made some improvements in her style of dress, and we began to notice that her face was often turned toward Alice, and that it would light up with a quiet smile whenever the dimples rippled over Alice's face, and while the smile lasted, we almost wondered that we had thought her "so dreadfully ugly." But when she had adopted Alice's style of dressing the hair, and hers rippled gracefully over her forehead, and clung to a tiny comb which just lifted it off her neck, we all pronounced her "*real pretty*." Her voice had lost some of its hardness—it had never been *harsh*—and now when speaking to Alice, was soft as Alice's own. For the rest of us she had the same hard look, and in recitations the same hard tone. We half-liked her because she loved our favorite so dearly, and I think it rather softened her feelings toward us, to know that we appreciated Alice; but the whole session passed, and she still kept aloof from us, and from the teachers as well.

There were several Alices in school, and each had one or more distinctive appellation other than the surname, for we made small use of that. Some were pet

names, and others not particularly suggestive of our affection for those who bore them. Every girl among us, except Lottie Hill, the stranger, as we persisted in calling her, was the particular friend of some other girl; but Alice Irwin was the confidant of each, the particular friend of all, so we very naturally called her "our Alice," until a circumstance occurred which suggested a title peculiarly appropriate for our Alice, and for no one else. We were all out one day in early spring for a ramble in quest of flowers. A part, with whom Alice sympathized, were desirous of going to "Sunrise Hill." The view from its summit was very fine, and there it was that the earliest violets and spring beauties were to be found. But the majority insisted on going down a by-path into the woods, where, they were sure, we should find a greater variety of flowers, and without the trouble of climbing a hill to get them. Dividing the party was not to be thought of, so we all went together down the path, which wound along the river-bank. Alice led the way, not because she chose to, but some one must take the first step in the direction fixed upon, and no one was ready till she had started. We went in a body down to the point where the path turned aside from the river, and then scattered in all directions in search of the flowers we were assured we should find growing in profusion, leaving the teachers there to await our return. Disappointment was pictured in all our faces, when, two hours afterward, we gathered back to the place appointed, and displayed our empty baskets. A good deal of vexation, too, was manifested by those of us who had wanted to go to the hills. We shouldn't have cared so much if we had sought the flowers for that day's pleasure only, but they were to have been pressed for the first pages of our herbariums, which we were impatient to commence.

"Isn't it too mean!" said one. "Enough to provoke even our Alice!" said another. "I hope it will," said a third, "so as to make those girls feel as bad as they can; because they would have it all their own way, and come here, when we all know that prettier wild-flowers, and more of them, grow on Sunrise Hill than anywhere else."

"Provoke *Alice*! I'll venture any thing that she'll come back happy as a lark. She always brings sunshine with her!"

"Well, if she does, she can't bring *flowers* to-day, and I know she had set her heart on getting some."

"Here she is with a basket full of something—surely not flowers, Alice," and we all crowded round her.

"Oh! no, there were no flowers, so I gathered mosses; see what a variety, and will they not look beautiful on the white pages of our herbariums. I've enough for us all, wouldn't you like them?"

"Alice, the Moss-gatherer!" said Lottie Hill, and "Alice the Moss-gatherer!" echoed we all, catching at once the thought that Lottie had left half-unspoken; and from that time it was Alice's title. Lottie's suggestion was made on the impulse of the moment, but it gave me a chance to open a conversation with her, without seeming to seek it. I made some remark about the fitness of the title. She replied that it was peculiarly suggestive of one trait in which Alice Irwin differed from everybody else; for though she would not fail to gather all the flowers of life, there were many paths where never a flower could spring, but where she would find *mosses* which no one else would think to gather, just as she would find something to like in a person whom every one else despised. Perhaps I only fancied that Lottie's voice faltered as she spoke, and perhaps

I was mistaken in supposing that her last remark was intended as a reproof for me, but I said: "Yes, we might all learn many beautiful lessons from her every-day life; Lottie, cannot you and I study them together?" My hand was silently clasped in hers, and from that hour we were fast friends, and Alice was the tie that bound us.

We were talking of Alice one day, as we usually did when together, which was very often now. "What a delightful home hers must be! I think she must have grown up among beautiful things and happy associations, and these have tended to develop all the good and the beautiful in her nature;" and then Lottie told me how far different had been her case. She had been early left an orphan, and had grown up, not only with no one to care for her, but with those who had imposed upon her tasks far beyond her years. At seventeen she had left a country village for the first time in her life, and had gone to the city alone and a stranger, and for three years had toiled first in one kitchen and then in another, for the purpose of earning the means of acquiring an education. When struggling on in poverty and loneliness, she learned to hate those who were enjoying all the comforts of life, and surrounded by friends. Alice Irwin spoke the first words of kindness that had ever been addressed to her. "There is a great deal of poetry made," she continued, "about the 'Ministry of Suffering,' 'Sorrow as a Purific,' and all that; but I tell you, I don't believe in it. It has brought out all the evil in my nature, and none of the good."

"But has developed strength you never would have dreamed of possessing if you had not thus been tested," said Alice, who joined us in time to hear Lottie's last remark. "Here, Lucy, is my offering to your flower-book," and she handed me the book, open to these violets clustering in the mass. "That is just the way in which I found them. I think it is the only time I ever saw flowers of any kind growing in a bed of moss, and to recommend them still further to your notice, they were culled from your little fairy glen." "But, Lottie, about that doctrine you were caviling at—I have always accepted it when stated in general terms, but when it comes to making a *personal application* of it, I don't believe I like it either. The truth is, I never gave it any thought, and probably never shall; that is, if my future gives me as little reason to investigate the subject as my past has done."

"Alice is taking a good deal for granted, that 'the future, as the past hath been, will be,'"

"I suppose she thinks, that 'If to hope over much be an error,' 'tis one that the wise have preferred."

"Why, girls, I don't know that I do hope over-much. I think less of what is *to come*, than what *is now*. My present is bright enough for any reasonable person, and I am contented to live in it altogether."

These were bright days for us all—the *brightest* that Lottie had ever known, and I thought then that every one of them brought out a new trait in her character to admire. Alice's presence was the sunshine that nurtured the germs of good, which, otherwise, might have been undeveloped.

Three years we were in school together, and then each turned aside into her own chosen path. But though widely separated, we still enjoyed each other's companionship, as our frequent communication by letter well attested. We had always corresponded during our vacations, and then it had seemed just like hearing Alice talk to read one of her letters, and to hear her talk, reminded one of the joyous choral of the birds in spring. But now the lightness

of her tone was gone. Not a word of sadness did she ever write, but always words of cheer, and this very cheerfulness troubled me, for to my mind that word conveyed the idea of a constant effort to be at peace, in spite of untoward circumstances, while Alice's joyous nature had never before recognized any circumstances as untoward. Very soon after leaving school she engaged in teaching. I was surprised at this, as she had intended devoting her first year at home to acquiring domestic accomplishments; besides, her brother had always strongly opposed her becoming a teacher; but she only stated the fact, and I did not feel at liberty to inquire into the cause. I learned afterwards, from another source, that an only brother, whom she idolized as the personification of all that was good and noble, who had taught her to look only to him to supply all her wants (her father died when she was but a child), had given himself up to dissipation, leaving his mother and sister to earn their own support as best they could. But the mother had long been an invalid, and so far from helping Alice, increased her cares. It was a light matter to her that she must toil for her own support, and it was a pleasure to provide for her mother's wants; but to see the brother she had worshiped as an idol, sink so low, was worse than death. He died, at length, in a drunken brawl. The letter that announced his death was written with a trembling hand; it stated that her brother had died suddenly, and that her mother was completely crushed by the dreadful blow. She inclosed a note which she had received a few weeks previous, informing her of the death of the one to whom she was betrothed. She said nothing of her own grief, but I knew that she had come into one of those dark places that Lottie Hill had spoken of, "where never a flower could spring," and I wondered if even Alice could find any mosses there. But she did not leave me long in doubt. She wrote: "All my energies are given to the improvement of my pupils, and to making my darling mother comfortable and happy. I know, Lucy, that your sympathies are sorely tried on my account, and while this makes me love you all the more, I assure you there is less call for it than you imagine. I am happy, not negatively so, but *positively happy*. You can't understand it? No! you never will until you have some loved one depending wholly upon your efforts for daily bread, and daily happiness. But for her own sake I should wish that my mother might remain thus helpless." And it was so for a year or more, and then her mother dying, left her utterly alone.

There was a fair opening for yet another school in our flourishing town, and in due time it was well organized, and Alice was the teacher, for I had prevailed upon her to come to me without delay. I had expected to see her crushed by this last weight of sorrow that had fallen upon her, but she still seemed cheerful, and entered with a good deal of spirit upon the duties of her school. She never spoke of her lost ones, but when alone with me, and then it was not with sorrow. She had a presentiment of an early death, and it was a joy to her, that they would not be here to mourn her loss. Speaking of this presentiment one day, she said: "Do not think that I die of a broken heart. I feel assured that I shall die young, and am glad to go, but I could live, if it must be so, and I think I could be happy. This is a beautiful world, if it is a place of graves, and there is always enough in the present, if not to fill our hearts, at least, to keep them beating."

And Alice did not pine away, but her presentiment was too soon fulfilled. A fever which was prevailing in town

fastened upon her and baffled the skill of all our physicians. Its course was of short duration, and when we laid her in the grave, there were many weepers for the stranger whom they had so soon learned to love.

This half-unfolded rose-bud was the first that bloomed upon her grave.

## Pen Illustrations of the Drafts.

For the New York Coach-maker's Magazine.

THE REPUBLICAN BRETT.

*Illustrated on Plate XXVI.*

THIS is an original design for a Brett which I think would look well, and as round bodies are in fashion now, this appearance can be very easily given to the panels by framing the figure with ratan cut into the mouldings, and all painted black except the panels. The neck of the body, which terminates in casing, may be made out of whitewood and fastened on the panel of the boot. This would give it a very stylish appearance. When the boot is thus finished, it would be better to dispense with the carriage-blocks, as too much casing in one place would not be very becoming. A door might be framed in the front part of the boot, should convenience require it.

J. I.

[Our correspondent having assigned to us the task of christening this beautiful draft, we have named it the Republican Brett; but, should the reader think that the adjective would have been better left off, we shall not dispute his taste. We think, however, that *American* designs should have *American* designations.—Ed.]

SIX-SEATED GERMANTOWN ROCKAWAY.

*Illustrated on Plate XXVII.*

It affords us much pleasure to present to our readers this month, another contribution from our talented artist, Mr. I. W. Britton. The carriage, of which we present a draft, derives its name from Germantown, in Pennsylvania, where it is said to have originated. It is a very popular carriage in Philadelphia, where, at least, we know of one shop that is constantly employed in making scarcely any thing else. Without intending to depreciate at all the beauty of this description of vehicle, built elsewhere, we must confess that many of those we saw in our late visit abroad—elsewhere described in this number—challenged our admiration. A very great recommendation in this style of carriage, is the circumstance that, although contrived to carry six passengers, yet they may be constructed very light, and at the same time be efficient and durable. This is effected in a great measure by the peculiar arrangement of the foot-board, which, projecting entirely in front of the forward spring, avoids the necessity of a long perch, constituting it a short-gear'd vehicle, roomy, and of easy draught. In this respect it differs in a striking degree from all other carriages, rendering it peculiarly an American "institution."

THE OSIER CAB.

*Illustrated on Plate XXVIII.*

THIS description of vehicle is something entirely new in this country, but from information derived from various sources, we have reason to include it among the institutions peculiarly English. We present it to our readers, rather as an eccentricity than as one of beauty in design. As is indicated in the name, the draft shows that this cab-body is constructed of osiers, or willows, and bound along the top rim, &c., in the manner usual in willow-ware. We think very little more need be said in explanation, as our engraving will enable any one to understand the mode of construction. The trimmings, if any are desired, will, of course, be in conformity with the taste of the builder. We think the style of a varnished carriage-part, peculiar to America, would harmonize well with the unpainted osier body of this style of carriage. The cheapness in which this kind of carriage can be made, is a recommendation not to be disregarded.

## Sparks from the Anvil.

COMPENSATING SPRINGS.

THE study of providing springs that will carry two or four passengers in the same carriage, with equal ease, has long engaged the attention of carriage-makers, and although many experiments have been tried, they have all failed in meeting the public wants. In the very nature of things, we fear complete success can never be accomplished. It is unreasonable to expect that seven pounds should make a spring calculated for fourteen, ride equally easy in both cases. It would be in contravention of all well-known mechanical laws. In order to overcome these laws in some measure, auxiliary springs have been adopted, which have been so arranged that they have only been brought into play when required, by a given superincumbent weight in business wagons, where appearances are not so much an object as utility. In American pleasure carriages, a certain compromise between light and heavy springs has in some cases been made, but with very indifferent success. The nearest approach to the desideratum long sought, is to be found, perhaps, in the springs termed "Telegraph," and employed in omnibuses and very heavy wagons.

Without going fully into the subject of describing the various devices employed as compensating springs in this country, we shall give one example employed in France, and another invented in England, and patented there by our friend and correspondent, Mr. Geo. N. Hooper, of the Haymarket, London; for the facts in both cases of which we are indebted to our London cotemporary.

The above example was found in a carriage hung upon a set of light elliptical springs, and exhibited at the London



Crystal Palace, in 1851, in a barouche sent over from Paris. These elliptical springs were made very light, and when sufficient weight was put upon them, additional support was derived from the additional bars at the top and bottom,

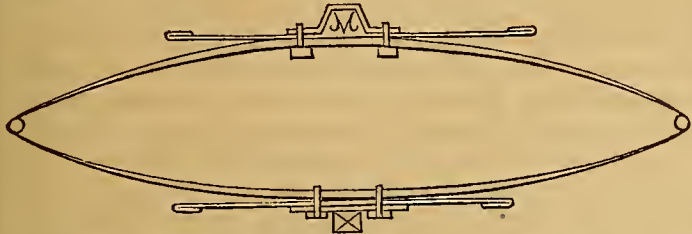

as illustrated in the cut. In this example, we are told that the bars were iron, but steel would be an improved substitute in such cases.

In the next example—Mr. Hooper's patent—we find india-rubber substituted for the iron bars in the Frenchman's example. Here, steel and india-rubber are made to act in conjunction. In connection with the steel springs attached to the front bed or hind car, is a pair of irons, bearing at the bottom a cross-bolt; a similar cross-bolt is attached to each axle by clips and coupling; on these bolts are placed the rings of india-rubber, three or more in number, according to the weight to be carried, but each of a different size, as seen in the illustration at A, B, C.

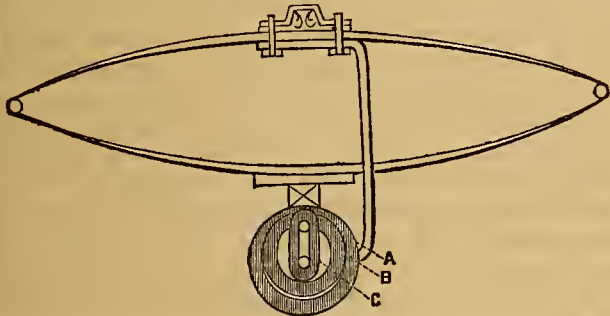

When the carriage is empty, only one ring will be in use, the others being unemployed, but when the weight is increased, the other rings will come into play, and aid in safely carrying the load over a rough road. A great advantage in this plan is the fact that the steel springs are so happily supported by the india-rubber rings, than any sudden shock is instantly shared by them, and thereby reduces the chances of breakage in the steel plates, although the steel springs are less than half the weight required without the india-rubber.

We have seen this principle partially carried out in a more simple and cheap way. This is effected by securing a circular ring of vulcanized india-rubber on the upper side of the lower half of an elliptic spring. This auxiliary may now be seen daily in use in this city. We know of, at least, one instance, where it has been employed several years. We may, at a future time, return to this subject. In the mean time, we hope this article will enlist the attention of some of our intelligent and ingenious readers to the subject, under the belief that it presents a wider field

for experiment than has yet been undertaken. We shall esteem it a favor to have the pleasure of placing the results of such experiment before our numerous readers, in a future number.

**INVENTION WANTED.**—At a recent meeting of the Polytechnic Institute in New York, Mr. Butler, a safe-manufacturer, stated, that at the present time, a very great necessity was felt for a machine that would straighten iron plates; as things are now, they have to be straightened by hand, and good workmen, at that business, are very scarce. Will some of our inventors look to the matter?—*Life Illustrated.*

**HARDENING IRON.**—A new process for hardening iron has lately been introduced, by fusing Franlinite, and dipping the iron articles to be hardened, into it. This qualifies them for standing the action of a cold chisel, file, or drill, without yielding.

## Paint Room.

For the New York Coach-maker's Magazine.

### GOSSIP FOR THE PAINT SHOP.

(Continued from page 135.)

It might be proper here to allude to the difference between English gold-size and American japan. They each answer the same purpose as the other, but how different are they in quality. There is just the same comparison that there is between the best English and the worst American varnish. Let any carriage manufacturer purchase one gallon of English gold-size, and see for himself. By using it for quick colors (instead of the thick, heavy pudding material we call japan), it has not one half that injurious effect that an inferior article has upon the durability of work, especially if prudently applied. To go and put quick drying color upon oil-paint which is not perfectly dry and hard, is sheer foolishness. But use it, when mixed with the best English gold-size, upon a good, hard surface, and it is not that contemptible substance which some wish to make it out to be. But we have now a new patent English filling, which purports to excel all others in its good qualities. The name of the firm that manufactures it, is almost a guarantee that it would be all they represent it. But I must candidly confess, in my opinion, it is not that superior article which it is claimed to be. I have used it now for near three years, and have had some excellent surfaces with it. But in a majority of jobs, it has been but very indifferent for an article which claims to be something extra, and which costs extra. There is not, in my opinion, that difference in quality which it is reasonable to expect for the difference in cost. Certainly, very trifling, if any, advantage is gained by using it. I should also mention that I have never, but on two or three occasions, used it according to their directions, having had always to substitute Japan for gold-size, which would make considerable difference. Still, I have a great inkling for the old-fashioned way of painting, which is every thing to be desired, if you only give it a reasonable amount of time. It was customary to give a body four coats of

the ochre filling, after three coats of good oil lead color, and to darken the fifth with a little lamp-black, so as to be a guide for the rubber. For the English filling they direct two coats of lead and six of filling. The difference is trifling, but, as I said before, three coats of lead are better than two.

During a residence of six years in America, over three of that time I have used the following course of filling up a body—not of my own fancy, but of him who was responsible for Saturday night; and, right or wrong, we are right in consulting his wishes. Having visited some of the carriage-manufacturing districts in the vicinity of New York, he came back with the following recipe for filling up bodies: Give two coats of pure oil white lead (not a particle of lamp-black to be used—it would ruin the job); a third coat, of part oil and part quick-drying lead, and afterwards three coats of white lead, prepared with one-half each of turpentine and japan; afterwards, one coat of quick-drying ochre as a guard for the rubber, and to prevent the stone from clogging. I have not any reason to find fault with this course of painting. I can now refer to work which I painted over six years ago, and you cannot detect a crack or an imperfection in it. I have primed and finished large booby-bodies under three weeks by using this filling, and I cannot remember any work that I have done that gave more satisfaction. The greatest trouble I found was in giving the hard wood a sufficient quantity of paint to fill up the grain.

I do not approve of spreading soft putty upon hard wood; rather apply thin coats, and more of them. I can not agree with your correspondent in vol. I. p. 171, that fillings should be put on heavy. No paint, with whatever mixed, should be applied "heavy." It would occupy too much space to mention a few of the different effects that various qualities of stock have upon filling. I shall only name one, that has come under my notice quite recently. We have some American varnish, which has a very good color, very pretty to work, and dries very good, to all appearances, in twenty hours. But come to rub it down with ground pumice-stone, in twenty days after being varnished, and after being rubbed three hours, it will shine, and sweat out, as if never rubbed, especially if standing in a warm room. A few weeks ago, I mixed up about thirty pounds of English filling, and instead of using one quart of japan, I put in three-fourths of a quart of this varnish. I had put on three coats, with forty-eight hours between each coat, and three with twenty-four hours, so that I don't think I hurried it. Each coat appeared perfectly dry and hard before putting on the succeeding one; but I found out to my sorrow afterwards, that the filling worked exactly the same as the varnish. I don't suppose a single coat was dry, as it should be, although to all appearance, it was as hard as granite. After standing one week, I came to rubbing, and it made a wretched job. Instead of the stone cutting, it seemed to drag, and scratch it up from the foundation, so that it looked porous—all full of little pin-holes, without much, if any, surface to it. It is perhaps needless to say, that that body began to crack before it left the shop—even before I put the first coat of paint upon it, after rubbing. Had that varnish been good, hard-drying varnish, it would have made a different finish.

Another thing, a boy put on the filling, and although perfectly capable of doing it, yet he might have put it on much heavier than I would have done myself. I know, in

this instance, it was laid on thicker than what I always direct it to be; which is one proof of that which I always assert, that no employer that manufactures good work, can hire cheap inferior help to advantage, in carriage painting; for it requires the greatest care from beginning to end, from priming to finishing. Every thing should be done right, just right; for every little wrong is liable to destroy all that has previously been done right, even to the laying on a coat of filling, which most people think is so simple. The greatest care should be taken, and all places where it has a chance to lay on thicker than it ought to, should be looked to, and cleaned with a small stiff sash tool. By allowing it to accumulate at the edges of panels, in the grooves, and upon the mouldings, it oftentimes starts the whole body a cracking, and all your precautions afterwards are worthless. It is the best way to make up all your filling at one time, and not make up enough for one coat, and have to make more for the next; but take an old one hundred-pound lead keg, and prepare as much as you think you will need for the next fourteen days. If you let it stand longer, you must keep thinning it, until there is no body in it. We will now suppose you have got all your filling upon your body; also, one coat for a guard for the rubber; you will now let it stand for rubbing just as long as you can do so, but don't begin to rub it under three days. It would be preferable if it were three weeks, during which time it ought to go down to the blacksmith's and be hung up; and not wishing to be over severe with the followers of "Tubal Cain," I would mildly suggest, that they don't put more holes in a body while in their care, than is absolutely necessary, especially if a little patience, precaution, or perseverance will prevent it; and should they have an occasion to place hot iron in proximity with soft wood, paint and varnish, please to remember, that these substances are not of that enduring quality that cast steel is supposed to be, and by not burning more than one inch through the wood, they will always oblige their compeers, the painters; and should the work be in varnish, they (the painters) will consider it a boon, especially if not more than a few pounds of grease and dirt should adhere to it upon leaving their small, clean, and delicate "maulers."

Rubbing the body comes next, which is very simple to those who know how to do it. In rubbing soft wood, always rub contrariwise to the grain of the wood. Never use a small piece of stone upon a large panel, or a large piece upon a small one. With the first you are liable to dig in and scratch with the edges; and in using the latter, you run the risk of rubbing your mouldings through to the wood. You should never rub down to the lead-color, to say nothing of the bare wood. Throw no more dirty water round the shop than you can possibly help; nor yet upon the canvas on the inside of your body. Begin your rubbing upon the roof and come downwards, being particular to wash off, and wipe dry, all you have done; don't let the water remain upon your body longer than necessary; it softens the filling and does not bear so good a surface. Having rubbed the job all over, it should stand at least ten hours to dry, when it requires sand-papering all over with fine paper. The corners should be properly cleaned out with a knife, and it is better to scrape all the paint from the outside of the hinges, as if left it is apt to chip. Cleaning of a body after rubbing, though to all appearances quite simple, requires to be done right; and simple as it is, there are but few men that give themselves the time to do it as

it should be done; if your body be slovenly passed over, and badly dusted, you cannot expect to find your next coat smooth, as it ought to be. Relying, then, upon its being properly sand-papered, hinge sand locks scraped, corners attended to and well dusted, it is now ready for the next coat of paint, which, like every other thing in carriage painting, is variously done by different men.

We presume your body has now a good hard foundation, so don't put any thing on it that will retard instead of forwarding it. When a body is at this stage of painting, circumstances oftentimes compel a man to do that which he would not do had he the opportunity of having his own way. At times a body is wanted for the trimmer by such a time, and to meet this demand, the painter lays on a mess of quick colors and has his body in varnish the day after rubbing it. Others put on what they ought not to do through the ignorance of not knowing better, and a great many men that know how it should be done, cannot do it, because the boss would begrudge the time it would take to do it right, and a majority of men that have piece-work, cannot afford to give work that time and labor which they know full well it ought to have, because the prices are so cut down that they have to do their work according to the price they receive, and not as they would like to see it done.

I would here remark, that there is no other branch in the carriage-business (and in but few others) where a workman can make his work so deceptive as in painting. A painter must have a very poor price indeed, if he cannot do his work according to it; for a few days' labor is easily saved, and the work, when finished, will not look much if any the worse for it, especially to the inexperienced eye; but the wearing of it soon shows it up, and that when it is too late to apply the remedy. I have seen men make up lead-color, one part japan and six parts turpentine; lay on a flowing coat, sand-paper off the next morning, and call this "facing" it. I frequently put a coat of lamp black all over. Some lay on their color, or the groundwork for it, and give the black paint a coat of lust-black; others think it indispensable to lay on a coat of oil-lead, which oftentimes proves the ruin of the body, as they do not give it a sufficient time to dry. Each and all of these may be good if judiciously carried out.

To put on a coat of lead not sufficiently "bound" is a waste of time and stock. To use lamp-black without it is properly prepared, and you have enough time to allow it to dry, is certain ruin to your body. To put on your color cannot be applied to all, and any color; and to lay on a coat of oil-lead, and have to put on your color before the lead is dry, is equally fatal to a good job. Let us examine them singly—first, by not having enough japan in your lead it will work up in your color, when in that case you would have to give an extra coat, which would be applying two coats when one ought to do, besides doing the job more harm than good. Secondly, the using of lamp-black for a groundwork, is a dispute among men whose opinion would carry more weight than my own. A friend of mine, a carriage-painter and varnish manufacturer of thirty-six years' standing, thinks there is nothing to equal it; he constantly uses it, and has done so for years; while I hear from another gentleman, one of the oldest and best painters in this vicinity, that, "if the boss cannot find him the best black to paint with, he don't want to paint at all. Any way, he an't agoing to put this common lamp-black upon his body."

There are men of experience who have grown gray at their calling (with due respect to their opinions I am constrained to say it), who think that common black can be used to good advantage, or it may be the means of destroying the durability of the work. All blacks are of a very oily nature, and require but very little oil in preparing them, or they will not dry by the time a carriage-painter requires them. All colors are very deceptive, and lamp-black particularly so, in drying; the surface feeling hard when it is any thing but dry underneath, and upon laying on your color, works up; and when one coat of paint works up into another, you may term your job ruined, for it is hard to remedy it without taking and washing the whole off. When I do use "common" black for a groundwork, I prepare it with about one part boiled-oil, and six parts turpentine. Even to use it so, it would not dry for some ten days: and japan should not be used for a dryer in this instance, as it makes it work to great disadvantage. If a small piece of sugar of lead be ground finely upon the paint-stone, and thoroughly rubbed among the black, there is no fear of its not drying, and making a good ground for all dark colors. Before applying the next coat, it should be rubbed with curled hair and dusted.

Thirdly: as to laying color, or groundwork for color: this is far preferable to laying lead or common black, without you are sure of its working right; for to lay on your proper color after rubbing, you are sure of starting upon a hard bottom, which, if you have a passable surface, may make a tolerably good job. To put on a coat of lead to advantage, it should be done very particularly; for if you only scratch it over with sand-paper the next morning, and lay on your color right away, it is a question whether the job is not better without it. That work should have lead after rubbing, no experienced workman will deny; but if not carried out, and proper time given for the attainment of the object desired, I would prefer putting color upon the filling. All painting upon coach-bodies should have a groundwork, or foundation, entirely independent of the first coats of lead and filling, and, to give it that, you have to use lead.

#### ORIGINAL ORNAMENTAL DESIGNS.

BY T. R. SHERRY, NEWARK, N. J.

*Illustrated on Plate XXIX.*

No. 1. In this figure the eagle of course should be painted with some color representing nature as closely as possible, and the shield red, white, and blue, shaded with Vandyke-brown in the darker shades. The rock on which the eagle stands should be of some dark color—say umber, blended with *terre de* or sea green. The stars in the shield are to be gilt, or deep chrome yellow, as may suit the fancy of the painter. The sea should be painted of some darker green, and blended with white, to form the foam, thus making its own dark shade. The olive branch should be painted olive-green, blended with white, and touched with yellow on the ends. The scroll is to be painted with yellow-ochre, mixed with one-fourth part lemon-yellow, and shaded with carmine in the darker shading; and be it understood, this is to be blended with carmine while it is in a "tacky" state. The dotting should be done with

Vandyke-brown, and the touchings up done with deep chrome-yellow; the ends of the leaves to be of the same color. We have been thus particular, in order to assist the amateur artist.

No. 2. In this figure the hound should be painted as near as possible to imitate nature, and the ground-work with burnt sienna, blended with deep chrome-yellow. The margin should be gilt, shaded with asphaltum, and touched up with white.

No. 3. Paint the larger shield with carmine, with which blend in a little vermilion, which will form the light shades required for the figure. The vessel should be painted with lead-color, in which a little blue should be mixed, in order to give it a bluish tinge. Color the sails with yellow-ochre, mixed with white, and shaded with Vandyke-brown. Paint the masts in some color to imitate wood, and the ropes with lemon-yellow, mixed with one-fourth silver-white, and shaded with Vandyke-brown; color the sea a dark blue, with light and yellow tinge. The stripe on the outside of the shield should be gilt. The ribbon should be painted blue, and blended with white. For the anchor use black, blended with white. The upper part of the small shield may be blue, also blended with white, and the lower portion white, shaded with Vandyke-brown; the stars gilt and the stripes painted blue. The ground-figure on which the figures stand should be painted to imitate nature.

### Trimming Boom.

#### STYLES IN CARRIAGE TRIMMINGS.

For the inside trimmings of the cheaper class of coaches, we observe that leather of different colors is extensively used for the linings to the seats and body proper. The "squabs" not being so easily formed from leather, are, of necessity, still made of silk or some other flexible material. For the finer class of carriages, it would appear as though the market was ransacked to find the most costly and elegant material possible wherewith to enrich the interior; some costing eight or ten dollars per yard. We were shown some coaches in a prominent manufactory in Rahway a few days since, trimmed in the richest kind of style, challenging the admiration of an Eastern prince. These were designed for the New Orleans market, and the profusion of silver ornament in every portion of the carriage, not excepting the outside trimmings, set them off in a gay style.

For buggies, cloth is the favorite material for the tops of cushions, and is mostly of a dark blue color; the other seat trimmings being still made of enameled and patent leathers. For the boot, as previously noticed, the best New York made buggies are paneled and painted patent black. For the inside of the tops, where sun-curtains were used, stitched patent leather, with heavy bullio

fringe and handsome tassels and cord for the "tie-ups," is extensively used. The liability of most silks to fade, has always militated against their use; still, no handsome substitute has yet been found to take their places.

Black corduroy, manufactured expressly for the purpose, is used in the trimming of the lighter road-wagons, and makes a neat and modest lining, in addition to its novelty of style. Black-stitching for New York city-made work, is the most fashionable style at present. We observe that white is still used extensively in work made for the Southern market, out of the city, as it gives a certain degree of "fancy" to a buggy, that meets with the Spanish notion of taste. New York made work, and a fanciful style of trimming thereto, have never been adopted, and probably never will, as the tastes of the people are more in favor of neatness and richness (costliness) combined, than of "flashy" and cheaper materials.

#### REVIVING POLISH FOR PATENT LEATHER.

WE have never tried the experiment, but are told that by putting half a pint of raw linseed oil into a quart bottle, the whites of two eggs, the two to be well shaken up, after which add a pint of stale ale, and half an ounce of butter of antimony, the whole being well shaken up together, will constitute a varnish that will much improve patent leather, when properly applied. It may, however, be improved by the following receipt:

Take 1 pint raw linseed oil,  
2 oz. spirits of wine,  
4 " vinegar,  
1 " butter of antimony,  
 $\frac{1}{2}$  " spirits of hartshorn,  
 $\frac{1}{2}$  " camphor,  
 $\frac{1}{2}$  " lavender.

Shake them well together, and the mixture is ready for use, by simply applying the composition with a piece of cotton batting wet from the bottle, and rubbing until polished, which is soon done.

STITCHING-MACHINE FOR LEATHER.—We have on hand and for sale one of Singer's best Stitching-Machines, which as we have no use for it, will be sold at a much reduced price. It was made expressly for us, is perfectly new and has never been used. Those requiring a machine calculated for the largest dashes, in the best condition, and at a low price, are requested to make application to us soon. Who wants it?

BLACKING BALLS FOR REVIVING LEATHER TOPS.—Take of ivory black, one pound; lampblack, one pound; levigated indigo, one ounce; gum arabic, four ounces; brown sugar, six ounces; half an ounce of glue dissolved in two pints of hot water. Mix the whole well, and it is ready for use. If required, half an ounce of spirit of wine may be added.—*Carriage Builders' Art Journal.*

## The New York Coach-Maker's Magazine.

JANUARY 1, 1860.

E. M. STRATTON, Editor.

### TO READERS AND CORRESPONDENTS.

**PUBLISHER'S NOTICE.**—*As the conductor of this Magazine is determined to make it as useful and interesting as possible, a general invitation is given to all in the different branches of the profession, to contribute to the different departments of the work, such improvements or new features as they may be cognizant of, anywhere in the United States, and when such matter is charged (if used) it will be liberally paid for. We hope that none will be deterred from writing or sending us sketches, under the impression that they cannot write well enough. We take it upon ourselves to properly see to that matter, under the conviction that the purest ore is often found imbedded in the most unsightly rubbish. The craft will much oblige us, if, when patentees call upon them, they would point out to them the superior advantages this work offers for placing their inventions before the craft. In this way much can be done in furthering the objects of this publication.*

**AGENCY—TO COACH-MAKERS.**—*The publisher of this Magazine offers his services to fill orders for any article his friends may want, to be found in the New York Market, FREE OF CHARGE where the individual is a subscriber. None but orders inclosing the cash are invited. Letters of inquiry, &c., MUST contain two red stamps.*

*All letters directed to this office on business, NOT relating to the Magazine, but solely for the writer's benefit, must inclose a stamp; if requiring an answer, two red stamps. Orders for a specimen number must be accompanied with nine three-cent stamps. When these terms are NOT complied with, no attention will be given them.*

*Name-plates furnished to order, of different patterns, for from \$14 to \$20 per hundred, at this office, or sent according to directions, by express, payable on delivery; to which express charges must be added.*

*A full report of the long-deferred suit against the leading coach-makers of New York City for alleged infringements, in using the perch-coupling, with illustrations, will be given in our next number. Single copies, price 30 cents, in stamps, by mail; or cash, at the office.*

**A. O'N., DUBLIN, IRELAND.**—A hub-borer has been forwarded to "7 North Strand," for you, through the American-European Express Co. This is thought a cheaper and safer way for you, than by any other conveyance.

**F. R., of VA.**—For the price of "the finest kind of charts," see scale of prices on page 133 of the December number, with which was furnished specimens. The cost of a single large chart is 30 cents. Where a card is to be inserted, no order can be taken for less than one hundred copies. Price, \$20.

**A. F., of PA.**—Your parcel was duly sent by express on the 24th of November. We can get you up name-plates "in every style" to order.

**E. D. L., of PA.**—The man calling himself "Thomas," never was authorized to act as our agent. You, and all others, should be careful when an agent calls, to see that he has the proper credentials.

**J. R., of GA.**—We act as agent in buying any kind of articles to be found in New York, as well as those for constructing carriages. There is however this difference: we charge five per cent. commission for goods purchased outside the trade.

**J. R., of Ark.**—The rule of charging for specimen numbers was adopted, to prevent the imposition practised upon us in sending for a copy under pretense of subscribing, merely to get one for nothing. The 25 cents paid may be deducted, should you afterwards subscribe, by specifying the number paid for.

### OBSERVATIONS ABROAD.

SUCH are the facilities of travel that distinguish the present day, that the business man, as well as the pleasure-seeker, may breakfast at his own domicile, in one section of the Union, and at night be found hundreds of miles distant. In nothing is the progress and advantages of science more plainly manifest than in the application of steam to the annihilation of distance and time. Months of time, as employed by our forefathers, are now crowded into the space of a few days, until it may literally be said, we live and move almost entirely by the aid of steam. But this is a digression.

We designed to say, that we have lately visited New Jersey, Pennsylvania, and the State of Delaware. One object we had in view in making this visit, was to make the personal acquaintance of our fellow-craftsmen in distant localities, under the impression that by so doing we were qualifying ourself the more suitably to perform the onerous task we have taken upon us in conducting this work. It affords us the highest gratification to find that our humble efforts, thus far, have met with warm approval and cordial support from the coach-making public. This pleasure is greatly enhanced by the fact that, while endeavoring to pursue a straightforward and independent course, we have still been able to conciliate the good wishes of the majority; and that, although we have restrained our pen from the immoderate laudation of any, for mercenary purposes, we have succeeded in pleasing the generality. We are, therefore, more than ever before convinced that our readers are far better satisfied with such a course of action than with the one of *wind and gas*, attended with sinister motives, as dealt out to them by another party. With these convictions in our mind, we shall pursue the even tenor of our way as heretofore.

In the places visited, we found business generally much prostrated, which, perhaps, ought to be thought nothing strange at this season of the year, but which, notwithstanding, must prove a serious matter to that class of workmen who are entirely dependent upon their daily labor for the means of supporting their families during the rigors of the coming winter. Some builders, in hopes that the demand for carriages would increase, have, with commendable motives, kept on their usual number of hands, but, unluckily for them, their hopes have been disappointed; business has not met their expectations, and now they find, at the beginning of winter, as large a stock of carriages crowding their sales-rooms, as the market of a busy spring would require. The unlooked-for effects of this will be, we fear, that many who have families to provide for, will not find work when it is most needed. Looking at this matter in this discouraging light as a historical truth, it will afford us much happiness to find hereafter that our predictions have proved premature.

Coach-making in the city of Philadelphia, is certainly a great "institution." The carriages there manufactured, are unsurpassed anywhere, and the gentlemen engaged in the business, as far as time permitted us to form their acquaint-

ance, were courteous and obliging. Particularly so was this the case at the establishment of Mr. Wm. D. Rogers; Mr. Wm. Dunlap; the Watson factory; Mr. Leffler's, and others, where we found many patrons of our enterprise. What has been said of Philadelphia, may be applied to Wilmington with equal truthfulness, in connection with the large shops. There we found several establishments, among the most extensive of which are Mr. Flagler's, Messrs. Hunsburger & Co's., and that of Mr. Pritzschnner's. It is remarkable how this place has increased in reputation for carriage-making within

a few years. We are promised some contributions from Wilmington soon, which we trust will serve to show that there is talent found there second to none. When we add that Philadelphia and Wilmington occupy much

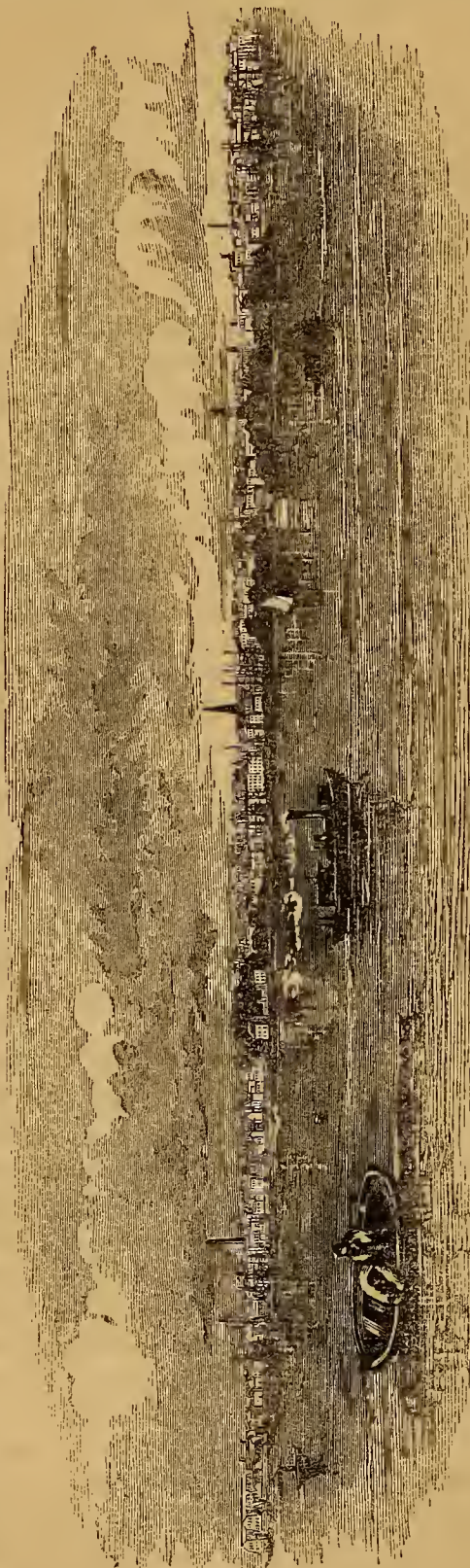

VIEW OF THE CITY OF PHILADELPHIA, PENNSYLVANIA.

of the space in our subscription book, we have said enough to show the good taste and judgment of the craft in those localities. The visit to these places has afforded us so much personal pleasure, that we shall endeavor another season to renew it, when we shall hope to extend our acquaintance and increase our patronage.

#### OUR ADVERTISERS.

We are accustomed occasionally, gratuitously, to call the attention of our readers to the cards of our advertisers, and to do it in this systematical way, instead of resorting to the manner some editors adopt of puffing for him who will pay the most. We are disposed to do for one, just what we will for another, and shall be well pleased to find them all satisfied with business. Since our synopsis in the July number, we have been favored with patronage from the following persons:

- AXLES, LEATHER-WASHERS, &c.—Wm. H. Saunders, Hastings, Westchester Co., N. Y.
- AXLE AND CARRIAGE MANUFACTURER—David Dalzell, South Egremont, Mass.
- BENT STUFFS.—Holcomb & Disbrow, Lambertville, N. J.
- CARRIAGE-BANDS AND OTHER PLATED WARE—The Ives and Pardee Manufacturing Company, Mount Carmel, Conn.
- CARRIAGE-LAMPS AND OTHER HARDWARE—Cary & Young, Newark, N. J.
- CARRIAGE-LAMPS AND OTHER MATERIALS—C. N. Lockwood, Newark, N. J.
- CARRIAGE-TRIMMINGS, PLATING, &c.—H. Galbraith, New Haven, Conn.
- CARRIAGE TOP-PROPS—Nichols & Thomas, West Newbury, Mass.
- COACH CARVING—Geo. H. Brown, New Haven, Conn.
- HUBS—Wilson & Belding, Rahway, N. J.
- HUBS—Wm. Miles, Newark, N. J.
- HUBS—C. D. Ingham, Chittenango, Madison Co., N. Y.
- SPRINGS—Wm. Wright & Co., Newark, N. J.
- SPOKES—C. A. Carter's Phoenix Works, Newark, N. J.
- SPOKES—Elizabethport Steam Manufacturing Company, Elizabethport, N. J.
- VARNISHES—Price, Bond & Co., Newark, N. J.
- VARNISHES—A. L. Cutler & Co., Boston, Mass.
- VARNISHES—S. P. Smith, Newark, N. J.
- VARNISHES—Pierson & Robison, Newark, N. J.
- WHIP-SOCKETS—J. W. Munson, Bridgeport, Conn.
- WOOD ENGRAVING—Wm. H. Redman, New York City.

Should the reader give the advertisements in our business department a careful perusal, he will find it a very interesting study, and perhaps should he go further and give some of them his patronage, he will be enabled to put money in his own pocket, or in other words, save money, which, when summed up, amounts to the same

thing. We have dealt with the greater part, and would cheerfully recommend them as fair and honorable in their business transactions.

#### COMMERCIAL REVIEW OF TRADE IN FRANCE.

THE following report of the present state of carriage-making in France we translate from the *Mercurè Universel*, published in Paris :

For some years back, coach-making, in general, has gone on regularly, credit in this branch of business having been established to a considerable extent, and commercial transactions had the appearance of being conducted in a legitimate manner ; it was not so, however, as what has occurred during the last two months but too well proved. The *Mercurè Universel*, not having been established for the purpose of estimating the industrial economy of the carriage-making business, it will confine itself to state its position, without commenting much upon it ; besides, as a large number of consumers read our paper, there would appear to be a certain evil intention on the part of the editor, if he were to expose all that is going on : there are other papers to announce the failures and suspensions of payment, as well as the names of those who are in that situation.

We will merely remark, that this season has been very disastrous to the coach-builders of Paris, four or five strong houses, carrying on the business in all its branches, having stopped payment, who only offer preposterous figures in liquidation ; four or five others, who only carried on the wheelwright and forging branches, being in the same condition. These facts, most assuredly, do not speak in favor of the trade, though it be a fine business, and, in our opinion, over-fine ; the unbounded desire of manufacturers to do business, as before stated, being what obliges them to sell even at a loss ; and however unpleasant this explanation of the causes of distress may be, it is not the less true. Now that we have mentioned what is occurring, we will say a word on the causes which have produced this crisis ; and let us hope that in making them known, the parties who are truly to blame, though they continue their operations under the shelter of law, will nevertheless experience some repugnance at dismembering the beautiful and magnificent manufacture of carriages.

OF CARRIAGE-DEALERS AND MANUFACTURERS.—There are in Paris two classes of carriage-dealers and manufacturers, which are :

*First Class.*—He who has been a saddler, a good or bad workman (that matters but little), and has established himself as a coach-dealer, and has a sales-room, large or small, and buys carriages ready-made, either finished or unfinished. The number of these carriage-dealers is considerably large, and is composed of worthy men on all accounts : nevertheless, among that number, two or three,

and perhaps four, are out of line as dealers ; they are very honorable, no doubt, but are, nevertheless, the ones who destroy, piece by piece, the beautiful carriage-manufacturing. The way that it is known or suspected by the trade that a manufacturer is pushed, is as follows : these men go to the manufacturer, and oftentimes the manufacturer goes to them to offer his merchandise ; the price fixed and agreed upon, is oftentimes less than cost. How then can the manufacturer hold out for any length of time ? That cannot be ; and, therefore, when it is seen that a carriage-maker sells to this class of dealers, it is said at once that he is ruining himself ; we do not think this epithet is any more flattering to him who ruins another, than it is to him who ruins himself ; the only difference is that one remains and the other breaks down. For our part, we wish with all our hearts, for the good of carriage-making, that those dealers who have made their fortunes in this manner, may become more generous now that they are rich, and that they would rather leave the merchandise on the hands of those who have been so imprudent as to manufacture them, rather than encourage or facilitate disastrous operations.

*Second Class.*—As to this class, it is much worse than the other ; they never had a trade, and notwithstanding, they go so far as to call themselves coach-makers ; they have ware-rooms, in which as many as fifty carriages, new and second-hand, may be seen ; but we will only notice the new ones, as every thing that has wheels and springs is called a carriage ; we say then that they are of the worst kind, because they are ignorant of the trade, and that they not only injure the manufacturers, buying from them only at the price of old iron (in fact, they are but old-iron mongers), but also injure those to whom they sell, for we defy any one to find in their bazaar a single carriage worthy to be so called.

#### DIFFERENCE OF TRACK IN DIFFERENT LOCALITIES.

It has always proved a matter of much inconvenience to carriage-makers, that in different States, and even in different portions of the same State, the widths of track are widely at variance with each other. This has proved a source of regret, especially to those who are more immediately dependent on sales of ready-made work than to those who make only to order. How much labor has the carriage-maker, at the risk of spoiling the job entirely, had to expend in alterations on a job before he could insure its sale, caused simply by this circumstance alone ? Just as though we had control over the matter, some have urged us to use our influence in obtaining a uniform track. This we would willingly undertake did we think there was any hope of succeeding ; but knowing that it is useless at present, we have come to the determination to undertake the next best thing : compile a table that may be reliable as a reference.

More than a year ago, we commenced this same work, but found we had not the knowledge necessary to complete it. With the view of carrying out our original intentions, we would ask of our correspondents that, when an opportunity offers in writing us on business, they would give us the track in their section of country, and state whether it is to be measured from "centre to centre," or otherwise, as the case may be, so that at an early day, we may give such a table as will be not only correct, but very useful to all manufacturers of carriages throughout the United States.

#### NEW SUBSCRIBERS

Will remember that in our last we proposed to take a few names to commence their subscriptions with the January number. This is done, because we find there are many who do not bind their volumes, and prefer to commence with the year. For such we have printed an extra edition of this number, and will be obliged to them if they will forward their names and money early. We shall, by so doing, still be able to accommodate those who wish their subscriptions to date their commencement from June, when the annual volume begins. We would also remind our friends, who wish to complete their sets, that we have still on hand, bound and in numbers, several of the first volumes, at the original prices, which we hope will be called for soon, as we do not design to print another edition, and the work is not stereotyped.

#### INFORMATION CALLED FOR.

We are extremely anxious to give in the concluding chapters of our *Coach-making Historically Considered*, a full account of the rise and progress of the business in this country. The materials at hand for this object are very meagre; we therefore shall be very much obliged to any of our readers, be he coach-maker or not, who will aid us with the loan of printed or written matter bearing upon the subject. A little assistance in this matter will enable us to contribute to the general interest, and preserve to posterity a history now hid in obscurity. It will be desirable to have the matter previous to the 1st day of February next.

#### LITERARY NOTICE.

*The Right Word in the Right Place.*—A New Pocket Dictionary and Reference Book; Embracing Extensive Collections of Synonyms, Technical Terms, Abbreviations, and Foreign Phrases; Chapters on Writing for the Press, Punctuation, and Proof-Reading; and other Interesting and Valuable Information. By the author of "How to Write," "How to Talk," &c. Price 50 cents.—The volume above named is the *multum in parvo* which we would warmly recommend to all our correspondents, and in confidence recommend to our numerous readers. It contains

the essence of three or four large folios condensed into a size and form convenient for the pocket, rendering it a suitable companion for a traveler's study. What a vast amount of educational proficiency would be gathered during a two-weeks' ramble abroad, could an individual be induced to study such publications as this, instead of wasting his time in *bolting* such sickly trash as is nowadays, by the press, scattered broad-cast over the land, and which to read is to poison one's mind. The Publishers, Messrs. Fowler & Wells, 308 Broadway, engage to send the work by mail to any address on receipt of the price. We opine that fifty cents cannot be invested more profitably.

#### FAMILIAR LETTERS FROM THE CRAFT.

RAHWAY, N. J., Nov. 25th, 1859.

*To the Editor of the N. Y. Coach-maker's Magazine:*

THERE are, according to the calculations of the editor of this Magazine, some twenty thousand carriage-shops in the United States, averaging about five journeymen to a shop; making a total, including employers, of some one hundred and twenty thousand men working at a trade where intricate mechanical skill and some artistic knowledge are requisite, and having a first-class Magazine devoted to the interest of the craft, with the advantage of its being published in the metropolis of America. Yet, with all these advantages, tending to develop any superior ability or genius that may be lying dormant in its craftsmen—for, unquestionably, some one or more in that hundred and odd thousand are men of genius—can the finger be placed on one—not two or three, but one journeyman, ay, or employer, that holds a position in his craft, equal to a Choate or a Webster among lawyers, a Watt or a Fulton among engineers? Is there one that has produced an original coach, carriage, or buggy? I know of none. I ask, Why is this?

From the many reasons that may be given, I select one: Some two or three hundred years ago, the times that we, in our superior civilization, call the dark ages, there worked at his forge, in the goodly city of Antwerp, a famous blacksmith, who brought lots of work and profit to his employer, and he (the journeyman blacksmith) *was paid* for his handiwork, as other mechanics, nowadays, are. But herein lay the secret of his success and our failure: his employer and the world recognized him as the designer of the elaborate work of his hammer.

If honor was awarded when and where honor was due, there might be found Quintin Matsyses in our day. The prevailing opinion seems to be, that a successful carriage-maker must be possessed of an auctioneer's talent, the faculty to sell work. Indeed, so much has the catering for the almighty dollar prostrated any inventive talent in the coach-makers' craft, that two large firms have offered premiums for an original coach-boot!

A. DUXBURY.

NEW HAVEN, CONN., Nov. 26, 1859.

*Editor Coach-maker's Magazine:*

DEAR SIR—Your favor, under date of the 22d inst., is at hand, acknowledging receipt of the subscription money for the club formed in our manufactory, for your inestimable gift to the carriage craft of the COACH-MAKER'S MAGAZINE. As the writer is about to start on a Southern tour, any items he can stumble upon, which will benefit or amuse the craft,



will be promptly remitted to you for the benefit of the same, in accordance with your request for an occasional contribution. "That Shifting-rail," known as Hibbard's Adjustable Top, has again turned up in the shape of a writ of attachment, lodged against our old friends Shelton & Tuttle, of Plymouth, Coun., in the office of the Town Clerk of Plymouth. I saw the junior partner of their house, Mr. Tuttle, yesterday (who, by the by, is gamy), and while in conversation with him, he said that they had plenty of evidence to bring forward upon the trial of the suit, provided "they" (the attorneys for the owners of the patent) should have *pluck* enough to complete the service of the writ, and bring them (Shelton & Tuttle) to trial for infringements upon Hibbard's patent. Your correspondent having watched the late controversy in this city with considerable interest, regarding this patent (which was published in your September and October issues), and having some facts in his possession of considerable importance, gave the promise of the benefit of the same to our friends who are now levied upon for contributions for alleged infringements, of which they are not guilty, they having made for years the old-fashioned shifting-rail attached to the sides and back of the seat-arms (not to the bottom and frame of the seat, as Hibbard does his), which old way must have been used before Hibbard was born, and certainly before he invented an article called Hibbard's Patent, granted in 1851, which no one ever has used or can use, and from diligent inquiry among the oldest carriage or buggy-makers, no one of them has ever seen it used or applied to a top buggy; on the contrary, I have now in my possession, a shifting-rail which is attached to the seat in the same way, viz., to the arms and back, as Shelton & Tuttle attach theirs, and as the generality of shifting rails have been attached, which was sold in 1835, on Canal street, New York.

We have authenticated records of this fact; in addition, we can affirm to the fact that one carriage-maker, now retired from the business, who, we think, is the oldest of the craft living, said to us while in conversation with him some weeks since, upon this subject, that the rail now used by the carriage-makers, generally attached to the sides and back of the seat-arms, was imported by him from England, on a carriage known as a Stanhope Phaeton, a half-century ago. We have never seen Mr. Hibbard, consequently can't say how old a man he is; but a half-century ago carries us back to 1809. Hibbard's patent was granted in 1851, and any mechanic of common capacity can see at a glance that between the old-fashioned rail and Hibbard's complicated Adjustable Top, there is no similarity whatever; and even admitting there was, for the argument's sake, the rail made by Shelton & Tuttle, and others, was born in 1809, consequently is a few years older than Hibbard's, say forty-two years; therefore, the rail born in 1809, must by this time have some gray hairs in its head, if not time's rust upon its body; while Hibbard's, bearing date 1851, must be young and of tender years, just commencing to prepare itself, by the help of patent lawyers, to fight the battles of its "short" life. Promising to keep you posted from time to time, as items of interest may arise, I am as ever,

Truly yours,

SHIFTING RAIL.

## INVENTIONS APPERTAINING TO COACH-MAKING AT HOME.

### AMERICAN PATENTED INVENTIONS.

November 8.—IMPROVEMENTS IN CARRIAGE-SEATS.—E. H. Harris, of Palmetto, Ga: I claim attaching the seat B, to the body, A, of the vehicle by means of the bars, *a*, and the rod, *c*, or their equivalents, so as to permit of a certain degree of play of the *e*, or movements thereof, independent of the body A, for the purpose specified.

November 15.—A DESIGN FOR CARRIAGE-BODIES.—Harrison Grosh, of Litiz, Warwick Township, Pa.

November 22.—AN IMPROVED SAW-SET.—Jared Beach, of Freeport, Pa.: I claim the arrangement of the guide, C, with slot, G, levers F and M, connecting link O, set-screws, 1, 2, 3, 4, and 5, when used in connection with the gauge, A, graduating rest-plate, D, regulating screw, E, anvil, I, and set, J, the whole being arranged and constructed substantially as described, for the purpose set forth.

AN IMPROVEMENT IN WAGON JACKS.—Charles Douglas, of Hebron, Conn.: I claim,

First—The combination and arrangement of the lever, E, pawl, F, ratchet plate, D, rod, C, and stock, A, substantially as described for the purpose set forth.

Second—The pawl F, when used for the double purpose of a pawl on the ratchet plate, D, and a fulcrum for the lever, E, as and for the purpose described.

AN IMPROVEMENT IN CARRIAGE-TOPS.—A. J. Hall and Russell Patten, of Morristown, Vt.: We claim the construction of bows for folding carriage-tops, with joints, substantially as and for the purposes set forth.

NOV. 29.—AN IMPROVEMENT IN MAKING HUB-BANDS FOR WAGON-WHEELS.—G. W. Beers, of Bridgeport, Conn.: I claim casting slits or holes through the bands sufficiently large to allow the solder, or other suitable metal used in connecting the cap to the band, to flow through them and unite them, as described, or in any other form or way equivalent thereto.

AN IMPROVED HUB-BORING MACHINE.—S. L. Bond, of Greenwood, S. C.: I claim the V-shaped bars or jaws, F H, in combination with the bit arbor, D, when the whole are arranged substantially as shown, to operate as and for the purpose set forth.

AN IMPROVEMENT IN MAKING HUB-BANDS FOR WAGON-WHEELS.—James A. Boughton, of Poughkeepsie, N. Y.: I claim the combination of the flange, C, and projection, D, on the leaf, B, and the set screw, E, in the open band, A, or their equivalent, for the purposes set forth.

AN IMPROVEMENT IN TOOLS FOR HANDLING TIRES.—John Brubaker, and Henry Brubaker, of Lancaster County, Pa.: We claim the rod-handled tong, fig. 2, with its sliding leg, C, hooked end, A, in combination with the ring, E, fig. 3, when made substantially as described, for the purpose specified.

AN IMPROVEMENT IN WHIFFLETREE-HOOKS.—S. M. Perkins, of Albany, Ill.: I claim, first, the combination of the stud with a revolving spring-button, arranged substantially as described for the purpose set forth.

Second, In combination with a revolving spring-button, I claim a stationary stop, D, so arranged as to prevent the eye of the trace, in all positions, from passing over the buttons.

Third, I claim the combination of the spiral spring, the projecting stud, and the inner stop, arranged substantially as described for the purpose set forth.

Fourth, I claim constructing the button, with the hooked end, substantially as described for the purpose set forth.

AN IMPROVED HARNESS-YOKE.—Z. Butt, of Lincolnton, N. C.: I claim the manner described of constructing and arranging the yoke, so that its weight, or the greater portion of it, may rest upon the back instead of the neck of the horses.

I also claim, in combination with the yoke, giving a wide base to the line of draft, either by the bolt and clevis, or any other equivalent device, for the purpose and in the manner set forth and described.

It is "all up" with the Russ pavements in Broadway, and by and by fewer omnibus-horses will go down.

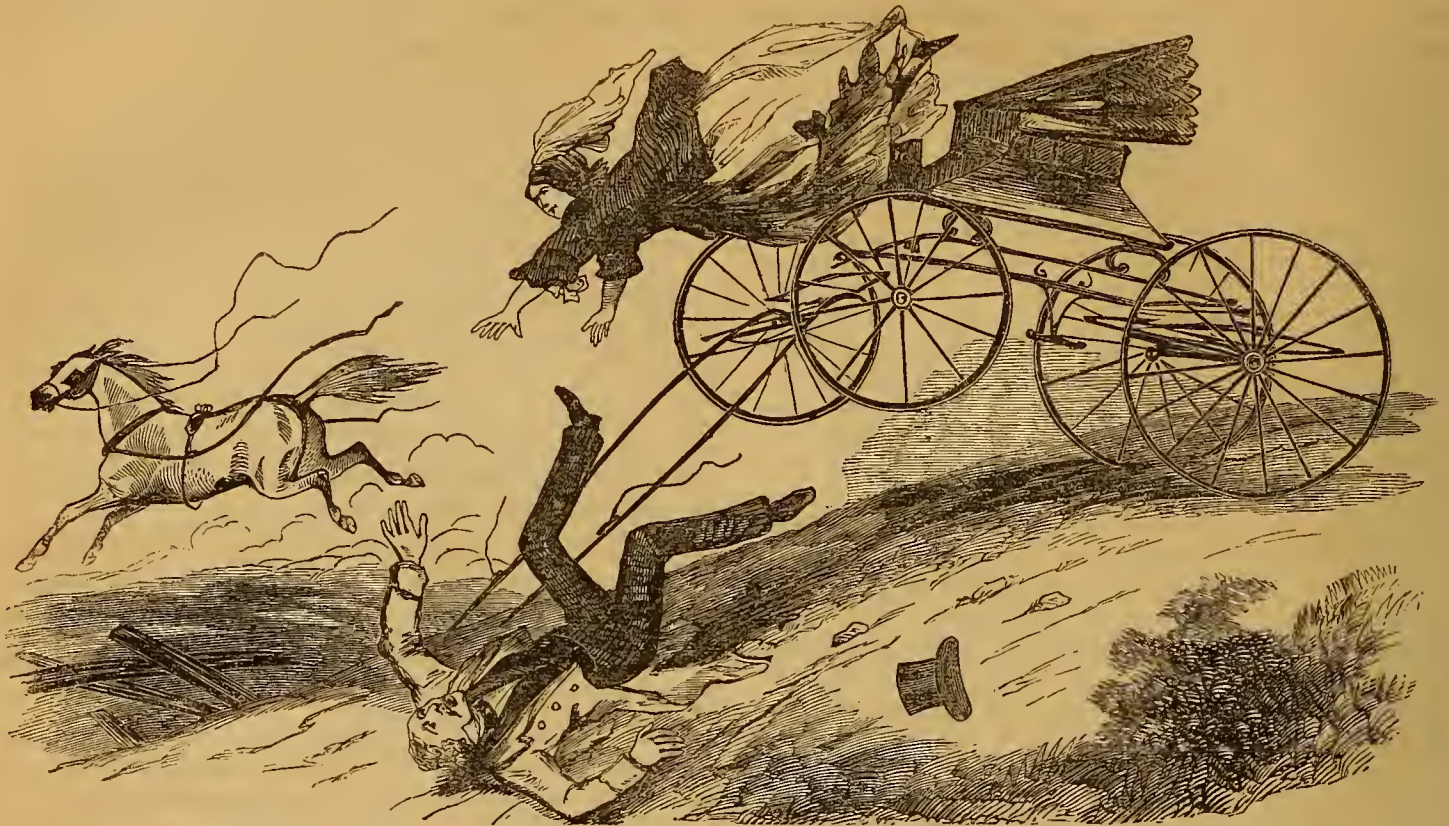

**STICKEMSTRONG'S SAFETY HARNESS.**—Squire Sponge-em-well, whose duties to his clients have deprived him of all opportunity for patient investigation of the mechanical sciences, has been induced, by the representations of Stiekemstrong, to purchase as a preventive against danger, one of his instantaneous horse-releasing apparatuses, for the protection of life in cases where a horse becomes frightened, and runs away with a vehicle. Having given the apparatus a fair trial, the result is found to be very satisfactory—to the undertaker.

#### RECENT EUROPEAN PATENTED INVENTIONS.

June 20.—Loring D. Dewey, 4, Southampton Buildings, Chancery Lane. Improvements in spring-seats for chairs, sofas, couches, carriages, and other similar articles.

August 11.—William White, 34, North Andley street, Grosvenor Square, a four-wheeled Safety Sociable Carriage.

August 19.—Peter Salmon, Glasgow. Improvements in locomotives, and in apparatus for warming trains of carriages connected thereto.

Swinton Boulton, Liverpool. Improvements in the means of, or apparatus for retarding railway carriages.

August 29.—Gilbert S. Fleming, 498, New Oxford street. A head-rest, suitable for keeping the head in a comfortable position in traveling, sitting or lying down.

August 30.—Robert F. Drury and Ensor Drury, Don Tool Works, Sheffield, Yorkshire. Improvements in vices.

Sept. 2.—Peter Wright, Dudley, Worcestershire. An improvement or improvements in the manufacture of anvils.

Sept. 3.—George Parsons, Martock, Somersetshire. Improvements in wheels.

Sept. 10.—Edward J. Mallett, Florence, Italy. Improvements in axles.

Thomas J. Perry, Bilston, Staffordshire. An improved construction of hot-air ovens.

Oct. 19.—Charles Sandford, Windover, Huntingdon. Design for "Dog-cart Phaeton."

**THE BAROTROPE.**—There has lately been invented in France a new sort of a carriage, so constructed, and running on wheels, that when a man sits thereon, he is enabled to walk along very fast by its aid. It is presumed that by the assistance of this contrivance, a speed may be obtained of "2:40," without any great exertion. Two men are said to have traveled five miles in thirty-five minutes, at mid-day, in one of the most crowded streets of Paris.

#### LONDON FASHIONS IN CARRIAGES.

**SPORTING CARTS.**—Long straight side panel, with long Venetian ventilators, high wheels, pillars to sail, three inches.

**LININGS.**—Dark blue and purple.

**LACINGS.**—Narrow, self-colors, and patterns, stripes.

**PAINTING.**—Heavy carriages, dark glazed green. Light carriages, lively colors, relieve with two or three lines of contrast, fine.

**LANDAUS.**—Step-piece before and behind, cut up sharp at each standing pillar, and straight from bottom side, with broad sham cane half-way down from end to end, French corner pillar.

**COACHES.**—Step-piece in front only, commencing short from elbow to bottom side at door, and but slightly swept; back corner pillar, the English sweep; front upper quarter all glass, with sharp corners four inches round, with centre front glass to go up and down; shallow panel; door to open through bottom sides, to allow the glasses to fall low.—*Carriage-Builders' Art Journal.*

**ALDERMANIC RIDING.**—It costs something, nowadays, to maintain the honor and dignity of Aldermanic "committees." During the pleasant months of July, August, and September last, a bill of \$6,868 was "run up" for carriage hire, for which the dear people must pay. Now, as each carriage is by law only allowed \$5 per day, these "committees" must have employed *seventeen carriages each day* during the quarter; and if they did not, they are as great a set of—humbags as can be found anywhere.

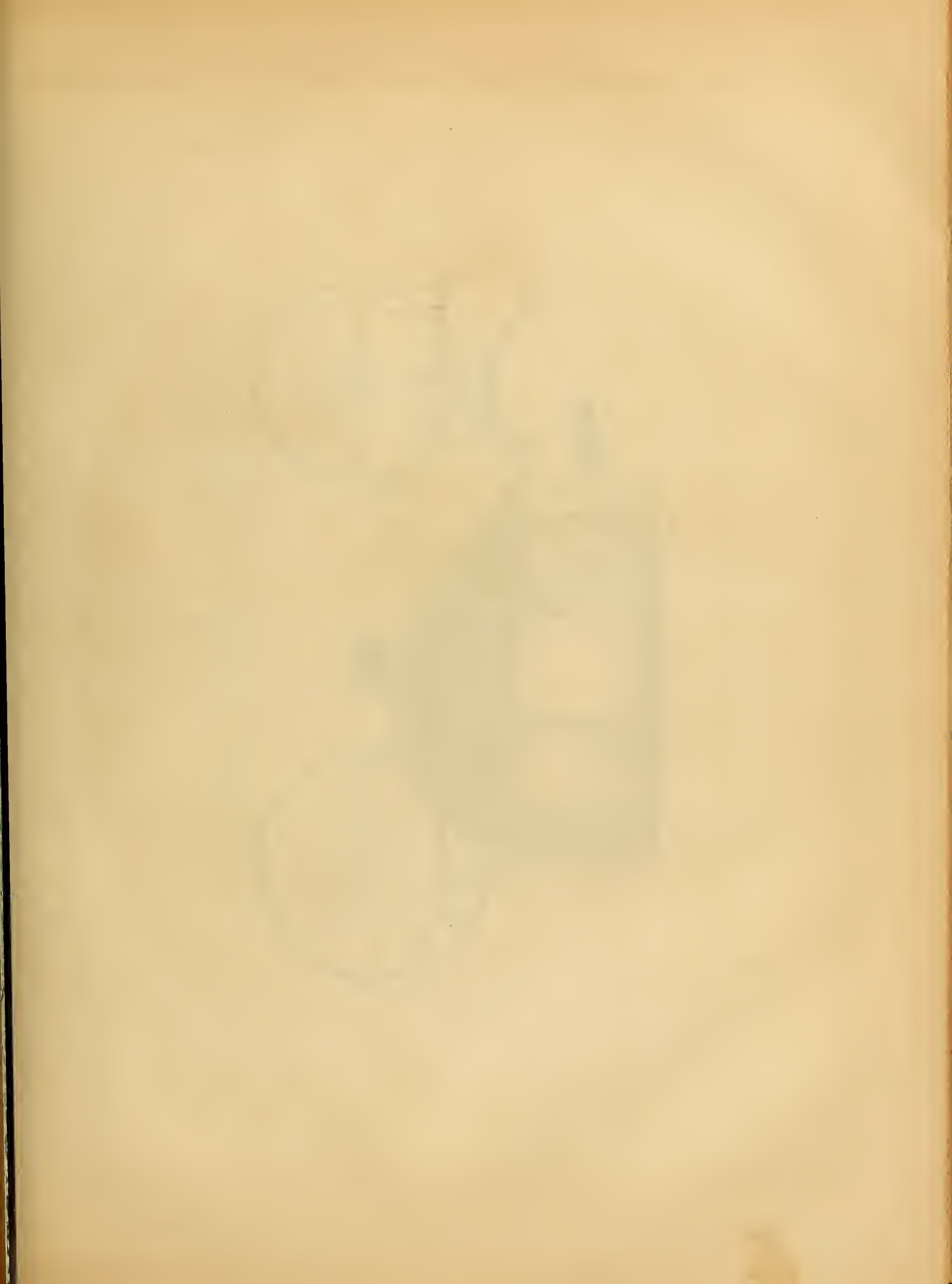

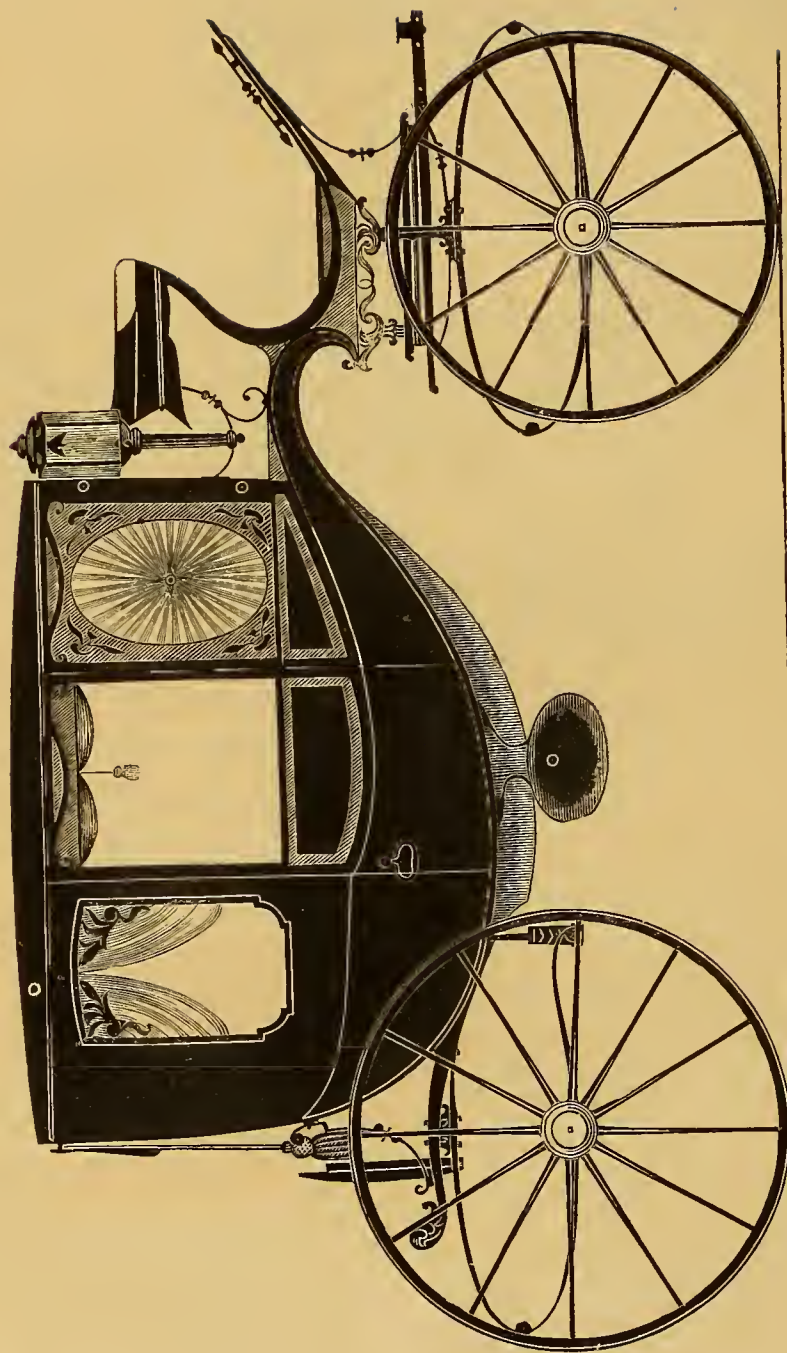

SCROLL-ARCHED CALECHE COACH.— $\frac{1}{2}$  IN. SCALE.  
*Engraved expressly for the New York Coach-Maker's Magazine.—Explained on page 169.*

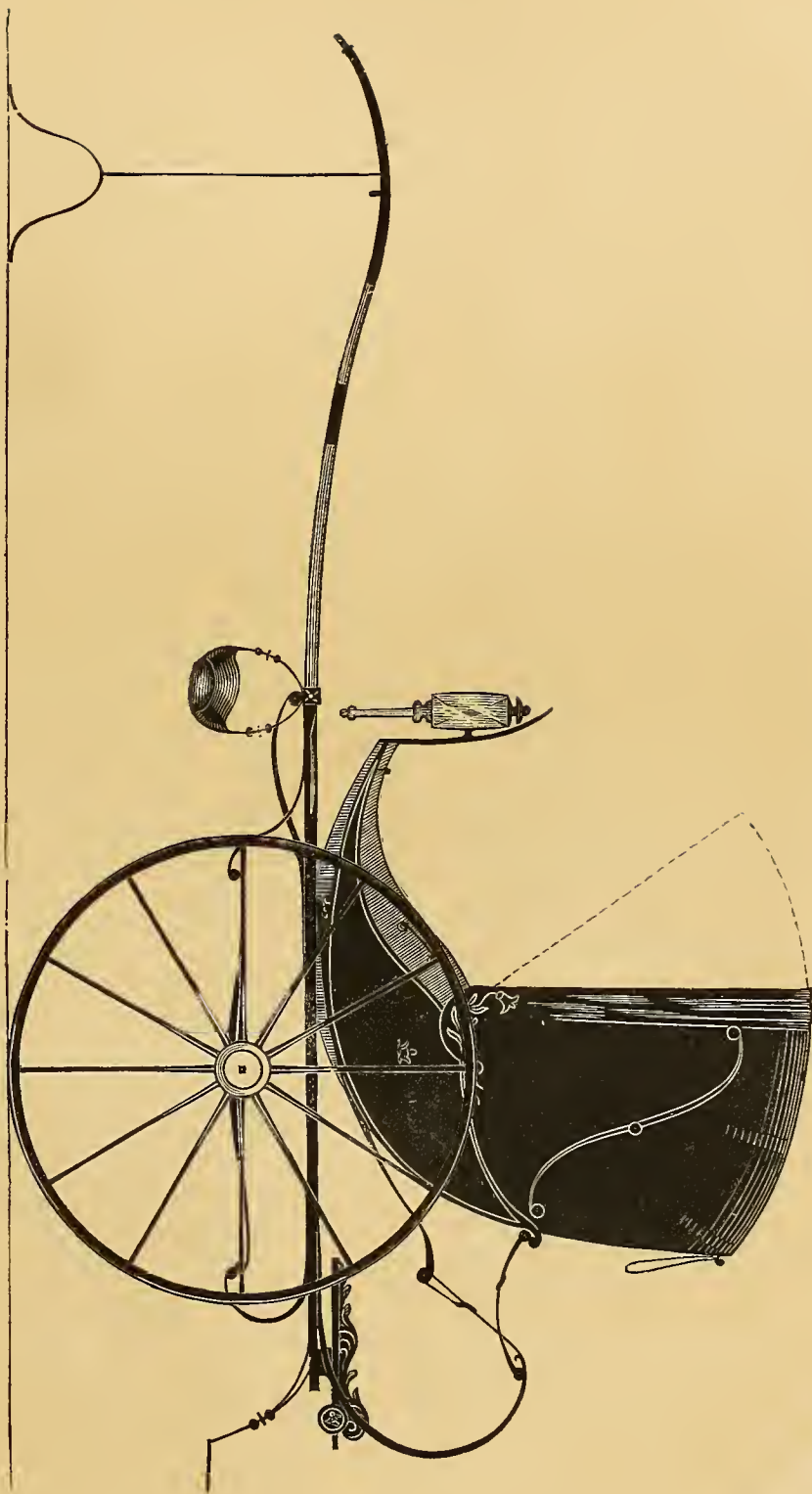

PHYSICIAN'S CABRIOLET.— $\frac{1}{2}$  IN. SCALE.  
*Engraved expressly for the New York Coach-Maker's Magazine.—Explained on page 169.*



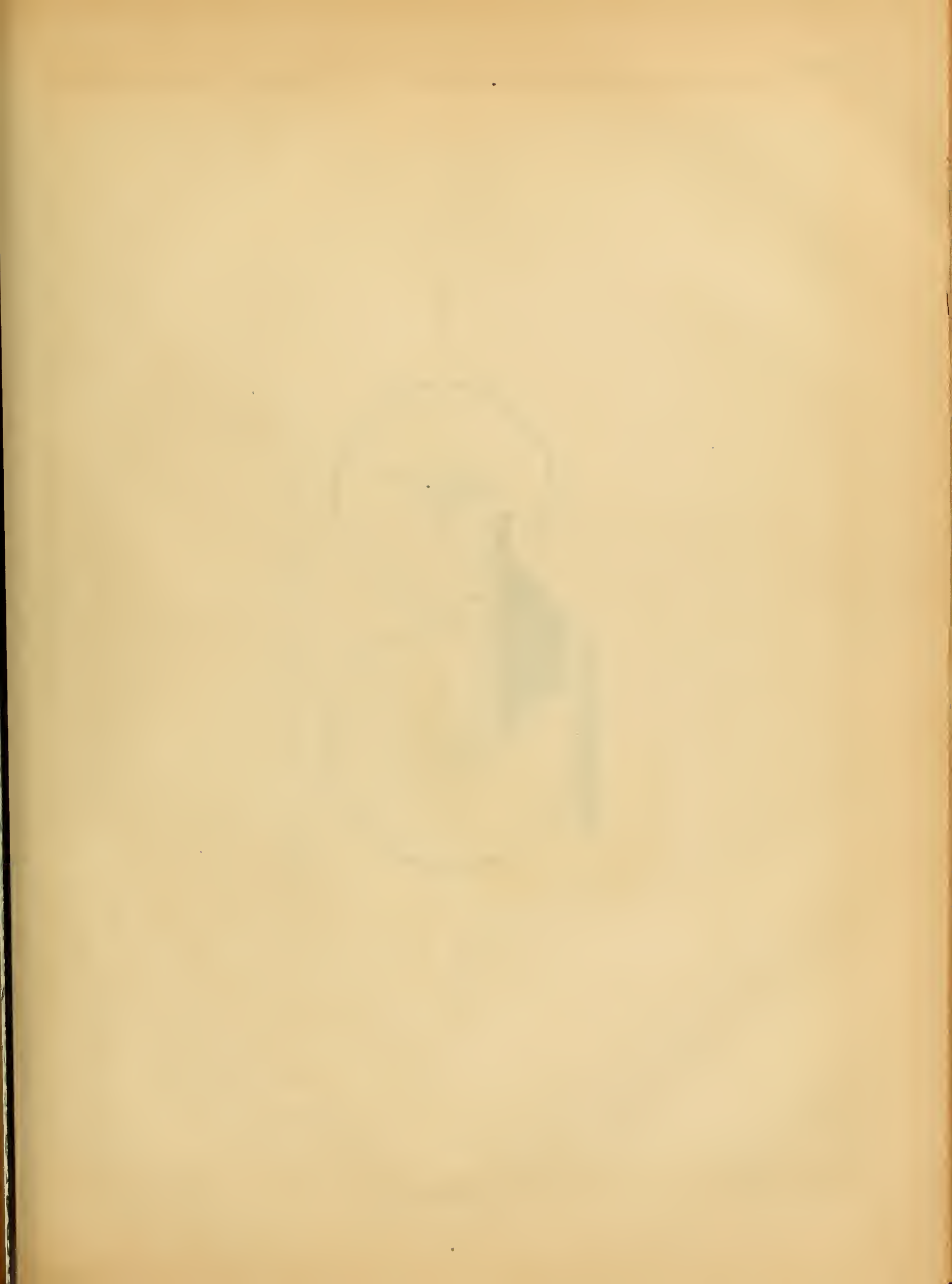

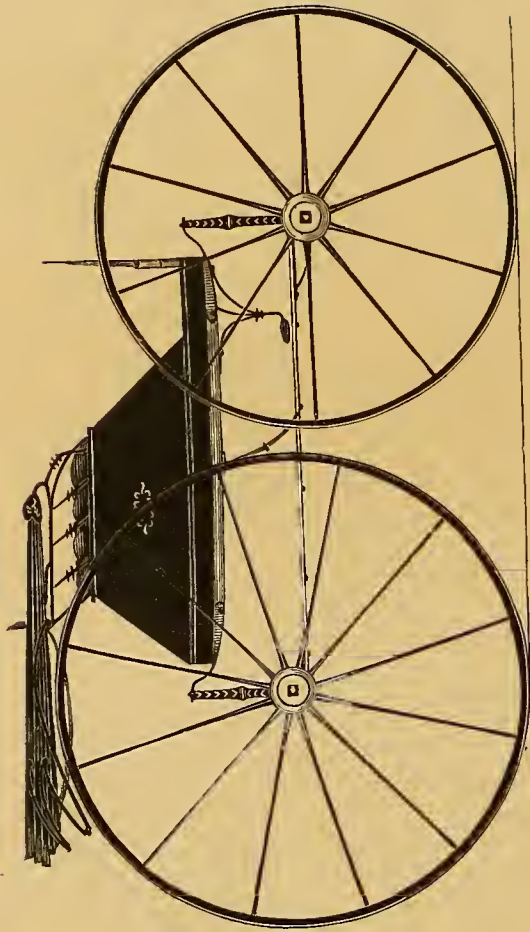

LIGHT PANELED-BOOT BUGGY.— $\frac{1}{2}$  IN. SCALE.  
*Engraved expressly for the New York Coach-Maker's Magazine.—Explained on page 169.*









DEVOTED TO THE LITERARY, SOCIAL, AND MECHANICAL INTERESTS OF THE CRAFT.

Vol. II.

NEW YORK, FEBRUARY, 1860.

No. 9.

### Miscellaneous Literature.

For the New York Coach-maker's Magazine.

#### CARRIAGE-MAKING IN BOSTON, MASS.,

WITH A CRITICISM ON "WESTERN WORK," AND THE FINISHING AND SALE OF CARRIAGES GENERALLY.

BY A BOSTON JOURNEYMAN.

THE benefits and advantages secured by a free and open discussion of the various ways different men take to perform the same piece of work, and especially when they have a journal so ably conducted and so respectable in appearance as "*our Magazine*," to promulgate and illustrate all the new styles and improvements which are constantly springing into existence, in carriage architecture, and other mechanical branches of the profession—particularly in a country so broad and extensive that that which might be thought proper and applicable in one section would prove futile in another—are so patent that they need only to be named to be fully appreciated. The different ways in which carriage work is made in the different parts of this country is a topic which can not but interest all engaged in the business; therefore I propose to say a few words concerning Boston-built carriages, and carriages manufactured in other States and brought to supply the Boston market, endeavoring to make it interesting to those subscribers who are not intimately acquainted with Eastern work.

Previous to the last four or five years, the greater part of the heavy carriages, both private and hack, running in Boston and the vicinity, was furnished by the wholesale manufacturers of other States; Boston builders confining themselves more to light work, such as buggies, chaises, carry-alls, &c., but the more this "foreign" work has been used, the greater dissatisfaction has it given, and consequently the Boston builders have recently given more attention to the manufacturing of heavy work, with such success that they can now almost supply the demand which is steadily increasing for Boston-built work. All carriages built in other States and brought to Boston are designated "Western work;" no matter from what quarter they come, they receive the same appellation; and if ever any work was run down and despised, it is Western work; not by

those who are unacquainted with its merits, but by those who have run it year by year; not by those who have had but one vehicle, and that did not happen to be a good one, but by those who have had three, four, five, and six. Such men will tell you they have had what you might call one good job out of the lot, but the rest was not worth stable-room. To such an extent does this hatred go, that any style of body, of trimming, or of iron work, which in any way resembles Western work, is discountenanced, with the idea that "it looks cheap, too much like Western work." No particular branch is named as being better or worse than the other. Wook-work is complained of as badly selected, and without that care and attention required. Trimming is complained of as being done from poor stock, the backs and cushions going, after a few months' wear, as flat as though they had been under a steam ram; "There is no inside to them," is the common expression.

The wheels but seldom give satisfaction, and painting, which looks so slick and clean when new, gives out, and too often cracks and peels off, almost before being used. This is no fault of the workmen who do this work, but of the ruinous system by which it is done. No sensible man would dare to charge them with incompetence or inexperience, for probably there are no better workmen found than those employed in large manufactories. When the work is made for the market, they have to be smart, and nothing but smart, to earn a comfortable livelihood, the prices being so cut down as to preclude the possibility of their doing more than that. No one knows better than themselves how they put their work together, and nobody knows so little about how it comes apart. You know that in the shops where it is repaired year after year, better than they can ever know, who never hear any more of it after it leaves the premises where it is manufactured; and this I take to be one reason why they are so prejudiced in favor of their own work, for it is a well-known fact that a majority of these men think that carriage-building cannot be done out of such and such towns, or such and such factories, and it is hard indeed to convince them that small concerns in such a city as Boston can build coaches, and sell them to customers who have had a number of Western coaches, and who gladly and freely pay from one hundred and fifty to three hundred dollars more for a Boston-built coach than for the best Western-built coach that can be brought

into the market. But that great monster, who is too often taken to be a great "lunk-head"—the Public—slowly though surely is susceptible of being aroused, and convinced of what is good for itself, the same as Boston stable and coach-owners are beginning to find out the truth of the old maxim, that "the cheapest bought, proves the dearest in the end."

Coaches made and brought to Boston for sale, are sold for from seven hundred to eight hundred and fifty dollars; a Boston-made coach, from one thousand to eleven hundred dollars. Such is the difference in the work, that I venture to assert that the Boston builder gets less profit from a coach costing one thousand and fifty dollars, than his contemporary from one costing seven hundred and fifty dollars, his stock and workmanship costing more than the difference. No stock can be too good, no pains bestowed by the workman can be too great, and the time occupied by the several branches with their parts of a vehicle is looked upon by Western workmen as monstrous. When we tell trimmers, that are accustomed to put the cloth-work in a coach in about six days, and who would complete it in from twelve to fourteen days, that it takes Boston trimmers from four to six weeks, they smile within themselves, and think what "old fogies" Boston trimmers must be; but when you tell them the price that is paid, they go in ecstasies, and visions of piles of dollars float before their vague imaginations. If they could but get a job in Boston now; if they were to come to Boston, they would find, in the first place, that it would be difficult to do the work at all, and if they could do it, they would soon find out, that though having one-third more money for the same kind of vehicle, they could not earn as much, by two, three, or four dollars per week. This I know they will dispute; it has been disputed by others, who by experience have become convinced. When a vehicle is finished trimming, you can feel assured that there is nothing wanting. After being roughly used for a considerable time, every thing seems in its place as at the time it was new. It does not have that flabby, slovenly look, as though the inside had been *thrown in*, which cheap work has when only used one half the time. Every particle of it is put in with a regard to its looks and durability. If a yard of lace is nailed in, and intended to be straight, depend upon it will be found straight; if wanted oval, it will be found oval, and true to a nicety. The cushions and backs are not made merely to look at, but to wear, and there is no lack of good curled hair, and an abundance of canvas to keep them in their proper places for a satisfactory period.

Most builders have their laces made expressly to order, furnishing their own designs; the leather is selected from the best makers in the country, and the price given is tremendously high in comparison to what it might be bought for. Boston trimming may challenge the world; it may be equalled, but I cannot see how it can be excelled. Whatever may be the shortcomings of the other branches in comparison with European work, American trimming, I believe, is universally acknowledged to be far superior either to English or French, and I think well deserves to be so; for its richness of material and elegance of design, its durability and beautiful finish, all combined, make it pre eminent. Every regard is paid to the selection of well-seasoned lumber for both bodies, carriages, and wheels, and it takes a good workman from eight to ten weeks to construct a first-class coach-body.

The price paid in Boston for making coach-bodies is about two-fifths more than what is paid by Western build-

ers; but the Boston coach has considerable more work about it, and the workman has not those facilities which are found in large factories where steam is employed upon the premises, which is a great help, especially to the wood-worker. If there is one branch more prominent than another in its superiority over this "cheap work," it is the blacksmith's. We hear men that have worked upon Western work, "blow," and tell how they used to iron a coach each week, and rip and tare, spout and splurge about the old fogysm of Boston workmen, who cannot do it in less than from six to eight weeks. These very men, in trying to imitate Boston work, cannot do it themselves in a less time than three weeks, and then they require two helpers to assist them; and when finished it is only an apology for carriage-work: it is not fit to grace the wood-work of a scavenger's cart: the springs and axle-trees are brought ready made to their bench. We do things a little mite different from what they are accustomed to. In a majority of shops the axles are forged and the clips solid with the axle; all the iron-work is forged out of solid iron. Every bolt and clip is in its proper place. Every plate beds, and is fitted to the wood; not the wood filed and burnt away, to fit the iron-work. You find not a particle of cast-iron upon the original Boston builder's work. Such will never pay here. Men who manufacture and depend upon the price they ask to sell their work, and have no scruples to use cast-iron in every available place, even to folding-steps—which the limbs, if not the lives of passengers, depend upon—only require enough time to extinguish their own prospects and success.

(To be continued.)

For the New York Coach-maker's Magazine.

## THE AUTOBIOGRAPHY OF CALEB SNUG, OF SNUGTOWN, CARRIAGE-MAKER.

### CHAPTER VII.

Apprentice-boys of all work—Mr. Flatt's enterprise in erecting buildings—Extract from *The Village Echo*—Mrs. Flatt's law against the use of candles—An apologetical digression—Caleb's pride, as practice developed his genuity, a little taken down by mistakes—Effects of Uncle Obed's cider—Mrs. Flatt "brought up, all standing."

SOME carriage-makers, at the time of which I am writing, had a peculiar habit of making their apprentices jacks-at-all trades. Unfortunately for us, Mr. Flatt was of this enterprising spirit. He not only put those who were with him to learn the "wood-work" of making carriages, much of the time in the paint-shop, but still further varied their employment at "blowing and striking" for the smith, with an occasional shaking of the flax-tow for the trimmer, *as a recreation*. Sometimes they might be treated to a job at whitewashing, or some other amusement, just as the economical judgment of the boss dictated.

I have said that our boss was an enterprising man. This was exhibited in his ambition for erecting buildings for stores in the village. Under his direction Sawgetup began to assume quite a business-like appearance, which gained for Mr. Flatt the designation of the Patroon. The principal of these buildings were erected on sites denominated made-land, and reclaimed from the river. His plan was to erect a square of stone-wall on the shore, at low-water, and to fill in the breast-work thus formed, with earth taken from an adjacent hill. The manner in which the stone for these docks was obtained, was of a piece with his other



“contrivances.” For the carrying out of these projects, Mr. Flatt hired a large flat-bottomed boat (or scow, as they are called), for bringing stone from a distance. These were found in profusion at the mouth of the Sawgetup. Taking the ebb of the tide, the otherwise unmanageable vessel was easily conducted down the river, whence, after being loaded, it was conveniently brought back again with the flow. On these expeditions he was accustomed to take “all hands” on a *pleasure trip*. Wherein the fun lay, I could never discern—it appeared to me too much like the two-acre-lot exercise, before mentioned.

Either to gain popularity, or else, as I suspect, to get the labor, as usual, done at a low figure, Mr. Flatt concerted a grand scheme, throwing all others in the shade, which, by the aid of a particular friend, was successfully carried out. This was to get a double-bayed barn erected on that two-acre lot—all the timber for the frame of which was to be hewn from the logs, framed, raised, and covered in, in the same day—in short, completed. This was actually done, as originally intended—in time, too, to have carried out the programme of threshing out a grist of wheat, having it ground, baked, and eaten before sun-set. For some unexplained reason, this last arrangement was not consummated. In its next issue, *The Village Echo* heralded this exploit through the country in the following editorial notice:

“WHAT ONE MAN DID!—Our enterprising fellow-townsmen, Mr. Diligence Flatt, has just successfully accomplished that which, we will venture to say, was never before done by any man in the State. With only sixteen carpenters, from the log he has built a large barn—hewing out the timber, framing, raising, covering, hanging the doors, and painting the entire building in one day, completing the whole by four o’clock in the afternoon. It was the intention of our esteemed fellow-citizen to have had—and for which there was ample time—some wheat threshed, ground, and made into cakes for the workmen’s lunch. Although there was ample time, this intention was not carried out. Such examples of enterprise as this are certainly worthy of record. Had we more individuals of this character, our beautiful village would speedily rival any other place in this county. May Mr. Flatt long live, for the benefit of mankind!”

Need the reader be told, that after this our boss was *the*

man for the times, and that his fame was published in every newspaper of the land? Such is sometimes the fruit of man’s matured ambition. So true it is, that success brands a man smart, when failure siuks him in disgrace!

There was one rule adopted at Flatt’s Hall which troubled us quite as much or more than any other; that was the rule Mrs. Flatt had made, which forbade the use of candles in our sleeping-apartments. Under the specious pretence from fear that the boys might accidentally set the house

on fire, this “institution” was adopted. To us who looked at the subject from another point of view, it was quite evident that such permission might cost the old lady something. This deprivation from necessity was endured for a time, but eventually our ingenuity supplied us with a light, which we were unwilling to forego—such of us as were fond of reading. Reader, do you, who have kind and considerate bosses, duly improve the privileges you enjoy, in storing your minds, during these long winter evenings, with that knowledge so readily obtained, and so much tending to enjoyment in after-life? Let us hope that you do, and believe, that with your other studies, the *COACH-MAKER’S MAGAZINE* has not been neglected. To correct in some measure the abuses of other days, is the design of these papers, and this should induce you to interest yourself in its circulation.

Sensible that mankind, generally, are disposed to censure rather than to praise the actions of others; in a word, as my mother often remarked, that, “there are more *find-faults*, than *mend-faults*”—it has been with some reluctance, that I have related some of the incidents of this narrative, lest the reader should charge me with having exercised too censorious a spirit in some of its details. As an apology, however, I will state that I have endeavored to picture a truthful history of the difficulties under which a trade was obtained forty years ago, and can assure my readers that it is not an over-wrought story of the writer’s experience.

I had now been at the trade some two years; but as my boss asserted he wished to have me well practised in “dressing up stuff,” I had never yet been permitted to do any job of difficulty, beyond that of getting-out and putting in spokes to old wheels. Every thing, then, had to be sawed out by hand from the plank, much more laborious than is the lot of more modern apprenticeship. But how proud I felt when I was set to putting in a wagon-shaft. It is true that it put me to some perplexity, when inadvertently the chamfer was run too far, so as to remove the shoulder required to perfect a mortise. The mortification which followed from the taunts of shop-mates, certainly *did* take off a little from the pride above alluded to; but when I was so far advanced as to be able to put in a wooden-axe, didn’t I feel the importance of

my position? And then again, was there not some cause for exultation when I was capable of making complete carriage-parts—entire bodies, wheels, etc.? Who that has pursued his calling with the least desire for improvement, has not felt a peculiar sensation, as step by step he made advancement? I will acknowledge that I felt myself already “one of the craft,” when I had overcome the *mistakes* of the chamfer, and was satisfied that *now* I was in a promising way of soon practically meeting the anticipations of my fond mother, and becoming a *practical carriage-maker*, in spite of my earlier predilections for sticking type.

On one occasion—a solitary one, I think—Mr. Flatt permitted his boys to attend the raising of a neighbor's new frame-house in the outskirts of the village. None but those who have lived in the country can realize the enjoyment found in such “bees.” The principal part of the male inhabitants turn out *en masse*, and each vie in their efforts to rival their neighbors in their volunteer aid to make themselves generally useful. On this occasion, “the boys” were particularly so—in dispatching Uncle Obed's cake and cider at the close of the *performances*, the cider having the effect to make many of them *sleepy*, before they reached Flatt's Hall in the evening. Mrs. Flatt's salt pork, no doubt, should be charged with these disgraceful results in some measure.

About this time “all hands” were suddenly brought to a stand-still, by the rumor that Mr. Wagonseller had suspended, and as he was largely indebted to the Sawgetup manufactory, it made a stir in *that* circle—not the least excited of whom was “the old woman.” She “couldn't see how a man of such large pretensions, could fail without acting dishonestly. The thief! to cheat and rob such hard-working people as us! So saving and industrious as I have always been; now to lose all by such scamps! he ought to be hung!”

#### HINTS ON THE PROPER PRESERVATION OF CARRIAGES.

In giving any general directions for the preservation of carriages, it may be as well, first, to remind owners of carriages that the better the workmanship and material, the longer it will last, and the less it will cost in repair; besides being less liable to breakage and failure, that so frequently occur to inferior carriages, and cause annoyance from happening, in most cases, at inconvenient times and places.

It must not be understood that all carriages should be equally highly finished: what would be proper finish for a court carriage, would be money wasted on a brake, omnibus, sporting phaeton, or carriage of that description; but for whatever purpose a carriage is intended, the workmanship and materials should be sound and genuine of their kind; suited for real work, and not merely to “catch a flat” by pleasing the eye with brilliant color or polish, that will soon disappear.

We will first suppose that the new carriage has just come home, and has had a fair time allowed for its construction. Any spots of mud should be removed at once, before they become dry, as all the spots allowed to become dry will leave a blemish.

The coach-house should be well ventilated, moderately light, dry but not warm, and free from bad smells, either from the stable, manure-pit, or other objectionable source.

By being well ventilated and dry, the polish of the var-

nish will last longer, and the lining will not become damaged by moth if occasionally brushed; by being fairly lighted, the gloss of the carriage will be better preserved, and being free from foul air and stable smells, will prevent the varnish cracking, and looking shabby. Thus far for the location. There should be a plentiful supply of pure water, and a carriage should be washed as soon after its return from a drive as possible. A vulcanized hose and pressure of water is the best mode of softening and melting the mud, or where this is not attainable, a common water-pot is suitable. After (and not before) the mud is well softened and has loosened its hold on the carriage, it should be got off with a good cloth rag mop, followed by a good sponge, to take the mud out of the corners of the moulding and from the carving; when this has been carefully done, the water should be removed, and the carriage dried with a damp chamois leather. The brass work should be cleaned with rotten-stone and oil, and silver work with the best whitening and water. The lining should be brushed out with a soft clothes-brush, and leather squabs wiped with a soft dry cotton cloth. Plate glasses may be cleaned up, after being wiped with chamois leather, by an old silk handkerchief. The braces and strapping should be dressed with a composition prepared for the purpose, and the japanned-leather work occasionally cleaned with a little soap in the water, to remove grease.

The fore-carriage should be greased about once a week with clean tallow; if black grease is used, it soils the paint, and oil washes off and sticks on the carriage.

The axles should be oiled every three or four months, unless the carriage works very hard, when intervals of two months are long enough; the best salad-oil should be used. The axles should not be interfered with, except by one accustomed to them—the best are so accurately finished as to require great care.

It will be observed that the ordinary “spoke-brush” is not recommended—its effect is to scrub off the polish of the varnish and make it look dull; washing the carriage with the naked hand is also to be avoided for the same reason, and should be given up where adopted, and left only to “cabby,” and such rough carriage “connoisseurs.”

It is in the long run more economical to have all repairs done when required. If the tires are allowed to run too thin, the wood-work of the wheels becomes jarred and shaken, and require an outlay which would be unnecessary if they were renewed at the proper time. Plates of springs should be repaired at once, for the spring having become weaker, causes other plates to break also, and so materially to increase the cost of repairs.

Re-painting should also be attended to in good time. The wood is preserved from decay by the paint and varnish. If this is allowed to become worn, and not restored, the water of course decays the wood, and rusts the springs and iron; as some parts become chafed much sooner than others, a small expense occasionally incurred, may eventually prevent a larger outlay than would be necessary if a carriage were left without an occasional overhaul by a competent and trustworthy person.—*London Carriage-Builders' Art Journal*.

POLITICAL JESTING.—The *Boston Courier* says: “It is a burning shame, that so long as there is a Coach-in China, our minister should be sent to Peking in a box, with no chance for Peekin' out of it.”

For the New York Coach-maker's Magazine.  
**GEOMETRY OF CARRIAGE ARCHITECTURE.**

BY A PRACTICAL COACH-MAKER.

**PART ELEVENTH.—BODY CONSTRUCTION.**

ON plate viii. of this volume, will be found a round-bodied coach, taken from a cotemporary. To construct a body of this kind is very simple when compared with that of some others. Notwithstanding this, there is no body made that requires more precision in its lines, sweeps, and symmetrical proportions. Let a carriage of this description be finished ever so expensively, still it is all thrown away, where the body is out of shape. Where these bodies are made rightly, they require but very little iron on the rockers; and are as frequently made without ironing as with. When a body is hung upon C springs, there is not so much strain or springing to it as when other modes of suspension are adopted.

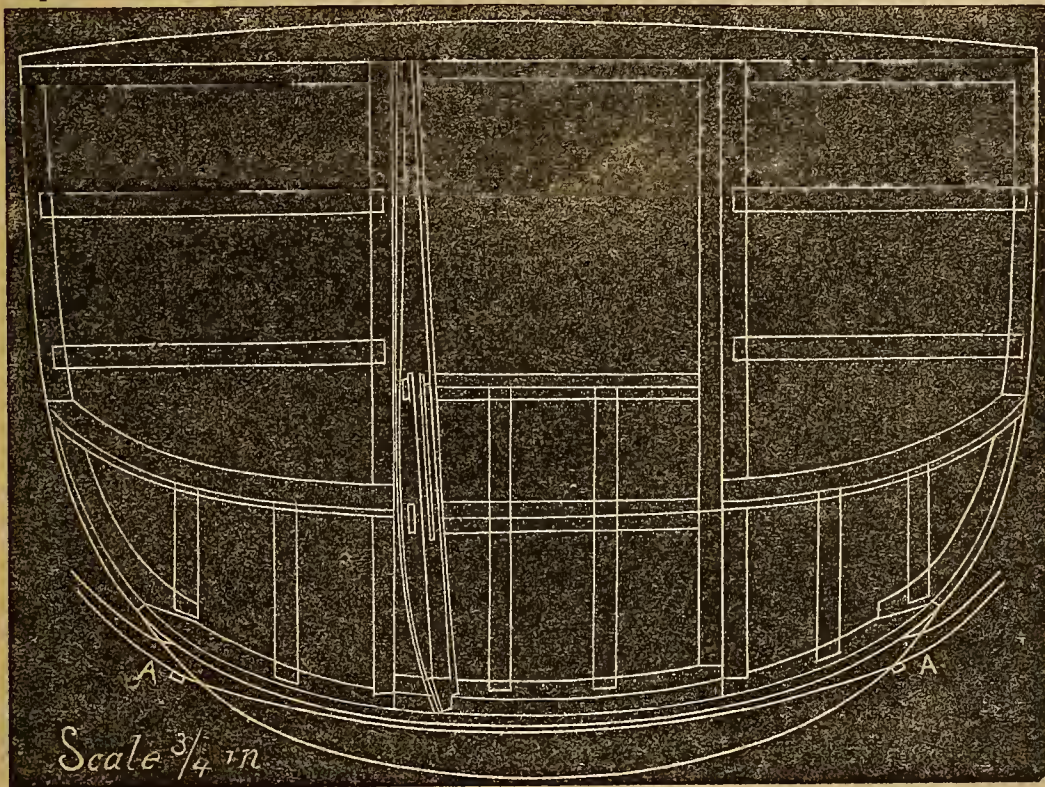

FRAME-WORK OF THE ROUND-BODIED COACH ON PLATE VIII.

It would be well to let the body-loops A A extend the full length of the bottom-side, and splice them under the door-way. In our example, the door-pillar is shown as when made for double frames, glass and blinds; Venetian blinds have been generally used in these jobs, but they are very troublesome, and it is very difficult to get the required locks and fixings. In consequence of this, gauze wire has been substituted, which looks very handsome for blinds.

In some cases, these have been ornamented with a painted landscape; but this is a matter of fancy. In our judgment, blinds to a carriage of this kind enhance its value very much. The back and side-lights may be arranged in the same manner of any size, according to taste. The heel of the body-loop should never be carried higher up than the tail or front bar to the body, as at that point the bottom-sides are weakened in framing the bars into them. If carried up above the joint, it would be liable to spring the body, when bolted.

**COACH-MAKING HISTORICALLY CONSIDERED  
 AND INCIDENTALLY ILLUSTRATED.**

BY THE EDITOR.

**CHAPTER XIX.**

Carriage-making in other countries compared with the English—England claims the advancement—Napoleon III. is even obliged to send to England to obtain a coach good enough for "our Gracious Queen" while visiting "the Nephew of the Uncle"—French omnibuses—Shafts, springs, and other material for coach-building examined—An American "looking-glass" for European carriage-builders, wherein may be seen how they appear to us; not much flattered, certainly.

WITHOUT going into detail the entire length of the report, we will summarily state, that Belgium produces carriages cheaper but inferior to France; that Austria is still further behind in skill; while Canada was represented in the French Exposition by "two light carriages" of moderate workmanship. Just in proportion to the enlightenment of the nation, in the same ratio will carriage-making

be found to have improved. With the following compliment to our country the report proceeds:

With the exception of Ireland and the United States of America, the manufacture of carriages in the rest of the world may be said to be in a backward state.

With regard to what is new in this department, the advance made during the last few years must be looked for more in improvements and useful adaptations, than in any striking inventions. Coach-builders are bound within certain limits. They have to provide vehicles to carry one or more persons, on two or more wheels; and the immense variety of carriages that have been made attests a very fair amount of ingenuity. Although the show of carriages from England is small compared to the contributions of the whole continent, it may be said that foreign builders have more to learn from the English carriages than the

English builders from the foreign ones, the best foreign carriages being still built in the English style.

The carriage called a "sociable," sent from England, is new to foreigners, and has already caused many to be built in Paris like it. The Emperor of the French procured two such carriages from England, expressly for the use of our Gracious Queen, while in Paris. A phaeton, with a novel kind of head, to lift by a very simple plan, has attracted attention; the plan will probably be adopted by some of the foreign builders. A "Pedomotive" is shown, consisting of a very high wheel, having a seat attached to both ends of the axle, which passes through both sides of the center of the wheel, and affords locomotion to two persons, who keep it moving by a light run. The inventor asserts that a high speed can be attained on a good road by his invention.

Some very good machine-made wheels are shown in the English department. There are also shown some good perspective views of carriages, produced by photography;

they are among the first produced by this means. There are also shown some good specimens of carriage laces. Among them are illustrations of a plan invented by Mr. Dart, for weaving consecutive numbers in lace, or even sentences, which, though not applicable to private carriages, may well be applied to the interior of railway carriages, and to the numbers on the collars of police and soldiers' coats, caps, &c.

In the French department a coach-builder shows an excellent full-size drawing of a carriage. It is chiefly noticeable for its good drawing, and not for its proportions and contrivance. A carriage is shown with panels of glass. Such a carriage offers little chance of durability, though to overcome the difficulties of bending and fixing the panels, shows a great amount of perseverance; it is an inferior carriage, with tawdry decorations. It is said to be sold for Mexico.

France shows a public omnibus of sound workmanship. It is much heavier than most English ones, but will carry fourteen passengers inside comfortably, each in a well-defined and separate seat; ten persons can be carried outside on a seat running from end to end of the roof, the passengers sitting back to back. A convenient raised rail surrounds the top of the omnibus, and insures the safety of the passengers, as it is not difficult to lose one's balance on taking or leaving a roof seat, should the horses move the carriage during the operation. The steps to ascend to the upper seats and to descend are very conveniently arranged. The driver is intended to sit quite alone. There is no door behind, the conductor standing on the step, and being prevented falling by a loose movable strap passing across the doorway; he is protected from the rain by a portion of the roof projecting over the step. The hind part of the omnibus is provided with a dial, numbered, and having an index-hand working from the centre, which the conductor has to move forward at the entry of each passenger, and at the same time causing a bell to ring; the state of the index is read off by a clerk as it passes any of the branch offices on the line of journey; the dial apparatus is opened and set back at the commencement of each journey, when its numbers have been finally read off. This is an excellent plan for keeping the money-taker honest. The driver can be signalled when to stop by pulling a cord so arranged as only to give a slight pull to his arm. The front springs are arranged in the same manner as the hind ones, namely, two side-springs, with a cross-spring. For heavy carriages, which carry uncertain loads, sometimes under, and frequently overloaded, it is an excellent plan, and so much better than the short, stiff elliptic springs invariably used for the front parts of English omnibuses.

On some of the French carriages are some pretty specimens of chased metal decorations—silver on gold, and *vice versa*.

The French especially show a multitude of plans for shortening the distance between the front and hind wheels of their carriages; they mostly consist of arrangements of slots of various shapes and curves, working on two fixed bolts. All such plans cause a rattle soon after being put into use, on account of the wearing of the slots and bolts.

There are also some carriage-shafts shown, formed of bundles of cane, bound together with wire. The inventor says it is impossible to break them by a horse falling; on the other hand it is said they cannot be made to retain their shape, and bend too much when in use. Some axles

are shown with the grooves in the boxes slightly spiral instead of straight; they catch up any grit which may by chance get into the box, and constantly carry up the oil to the back of the axle when in use. There are also some axles made on an economical plan for common carriages; there is only a small collar to the axle; the reservoir of the box covers it, and keeps out grit; the collet and nut are in one piece, and of iron; the cap to contain the oil in front is of cast-iron.

Some very ingenious machine-worked panels are shown. They represent various patterns of basket-work in excellent imitation, and are used in France for panels of sporting and light carriages. Some economical elliptic springs exhibited are made by turning up the end of the back plate on edge, and passing a bolt through a hole in each plate. They may well be applied to light, common carriages for country use. There are also some well-contrived single and double carriage-steps, opening and shutting with the carriage-door.

Many of the French carriages have the spokes of the wheels made of acacia instead of oak. This is a wood which has been extensively used in France of late years for this purpose; the French builders speak very highly of it, and maintain that it is far more durable than oak. The wood brought from the Departmente des Landes is considered the best, on account of its toughness and the closeness of its grain; it may be procured from Bordeaux. For light wheels they are using tires of what they call "acier naturel." What this is I have been unable to ascertain; whether a cast and rolled steel, or iron treated by some method to harden it. It welds as well as iron.

We have thus given a view of carriage-making in Europe four years ago, from an English stand-point, and in concluding this chapter, shall present our transatlantic contemporaries with an *American* "looking-glass," which, when they come to see themselves therein, they will find not very flattering to their pride.

One gentleman of our acquaintance, who visited Europe at the period of which we are writing, tells us that he went through the principal coach-manufactories in the city of Paris, and conversed with the workmen, inspecting the work in course of construction—principally coupé and barouches—which they denominated light work, but which we, in our judgment, would call very heavy and clumsy, and not at all to be compared with our light and graceful vehicles of the same description in the city of New York. Besides, this gentleman informs us, that the repositories for carriages in Paris were but poor concerns when compared with ours, both in the quality and quantity of the finished work contained in them.

From the specimens of English and French vehicles that have come under our own observation in America, we discover many points in their construction, that in our opinion must be pronounced a weakness, to say the least of it, particularly in the arrangement of the fifth-wheel to those carriages built without the perch, and in some examples the attachment of the shafts has proved very faulty; we would not consider the arrangement suitable even for a child's wagon, to be drawn by nurses. Now, how are we to account for the superiority manifest in our productions, both as regards their lightness and finish? Does not competition among ourselves contribute in a great degree toward accomplishing this state of things? Do not the free and general diffusion of knowledge, through the means of our public schools, and the latitude we are



accustomed to give to our thoughts from childhood, produce these desirable and satisfactory results?

Our timber, doubtless, being much better in strength and greater in variety, gives us one advantage over our transatlantic craftsmen; yet on the other hand, they possess old and macadamized roads, with which the new and comparatively wild ones in this country cannot be named, and yet under all these advantageous circumstances, they continue still to make their work clumsy and as heavy as did their predecessors before them, to the evident destruction of horse-flesh.

The intelligent and liberal-minded portion of the English public, and carriage-manufacturers, freely admit that which is the fact, that in style, lightness, and durability, our best carriages very far exceed any thing of the kind produced in their own country. There is, evidently, a superior degree of talent and taste among the coach-makers of America, which cannot be found in the old world, and in which state of things we may feel an honest pride of ourselves and strong encouragements to excel in the future. With these remarks, we shall conclude what we have at present to say of foreign matters, and in our next chapter treat of the history of the art in our own country.

For the New York Coach-maker's Magazine.

### RALPH LONG'S STORY.

BY JAMES SCOTT.

Two years of life in the metropolis had effectually effaced all traces of my rustic origin, and transformed the verdant graduate of a country shop into the city jour, who talked learnedly of the "French rule," the art of carving, and the respective merits of basswood and poplar for panel-stuff. Nor was the transformation confined to the details of my trade. The lad who was the best spouter at the village Lyceum, and was scarcely ever known to be absent from singing-school or church—the lad who never took an oath, told a lie, or robbed a water-melon patch—was now a member of a fast fire-company; talked "gallus;" could box as well, hit as hard, throw a brick as straight, and stand up under as great a number of gin-slings, as the most accomplished prototype of "Mose." In short, I was making a bee-line for perdition at railroad speed, with brakes up, and no friendly hand outstretched to switch me off the track. Dissipation, and the exposure attending the life of a fireman, were making fearful inroads on my health; in all probability, my mad career was nearly run, when in a drunken fray I was knocked senseless by a blow on the head with one of those murderous weapons called slung-shot. That blow was directed by the all-wise Providence that exerts so great a power for good in the affairs of men, for it proved a blessing in disguise. For many long weeks I suffered the most excruciating physical torture; and when the skill of the physician at length allayed that, it was succeeded by mental agony scarcely less severe. Left alone with thought and an accusing conscience, the mad folly of my career in the city was stripped of the deceptive glitter that had charmed my inexperienced senses, and now stood out in all the dread deformity of ungilded reality. The reaction of feeling I underwent was terrible, and filled my very soul with despair. In my youth I had heard of drunkards—of men hurled by the fell demon of Intemperance from opulence to the gutter—from respectability to infamy; but in the

full consciousness of my moral integrity and loftiness of purpose, the fear that I myself might fall, had never been for a moment entertained. My country friends, when I left them, had warned me of the "dangers of the town;" but I laughed at the seeming simplicity of their advice, and boastfully denied the power of the most subtle temptation to shake my strength. Alas! how fatally did I deceive myself.

A fit of deep dejection followed these paroxysms of self-crimination; and as it seriously retarded my recovery, the physician advised change of scene, and thought a short residence in the country would be beneficial. I seized on the suggestion with avidity; all that was good within me, every impulse and thought that was pure, bounded into new life at the idea of leaving the contaminating atmosphere of the city, and breathing once more the free, health-giving, and good-inspiring air of the inland hills and valleys. A half-formed determination I had made to lead a different and better life, grew into promising vitality, and hope drew bright and cheering pictures of a future rendered happy by a victory over self.

Spring was busy retouching with vernal tints those beauty-spots of nature annually seared by the scathing breath of winter, where my health-seeking pilgrimage was terminated by finding what I most needed—a good job in a quiet pleasant locality. The village of Crampton was the county-seat; and although the number of inhabitants was small, there were evidences of much wealth and enterprise in the busy work-shops, well-stocked stores, and comfortable, often elegant, dwellings. The carriage-shop where I obtained employment, was a perfect model for a country establishment. The proprietor proved to be a thorough mechanic, and an honorable man, liberal as to prices, and prompt to pay. Board was cheap and good, so there was nothing lacking but a contented mind to make me happy in my new abiding-place.

In conformity with the course of discipline I laid down for the uprooting of my vicious habits, books became my evening companions, and profitable ones they proved. Long walks on the banks of the winding river, or up among the rugged hills, were my morning pastime; and the work-bench was sedulously occupied at least ten hours daily. With the return of other good impulses, that had long been dormant, came the consciousness of that sacred duty we all owe our Maker, and when the Sabbath came, I sought the village church, hoping in my heart to gain strength by joining in worship with those whose pure lives gave them easy access to the throne of grace. That rustic sanctuary, with its earnest, unostentatious worshipers, was a picture to move the most hardened heart; and when all joined in the opening hymn, no more impressive music ever greeted my ears; there was no laboring after musical effect to mar its solemnity, or divert the mind from the sacred theme of the poetry. And yet, one bird-like voice of peculiar sweetness and power, that arose just behind me, sadly interfered with my devotions. Truant fancy, ever on the wing, even in sacred places, pictured the singer in a style of loveliness to match the exquisite beauty of the strains she uttered. So palpable was the image to "my mind's eye," that my thoughts wandered for a moment from the hymn, and I longed to turn and see if the gentle singer and my ideal were identical. As the voices ceased, all turned to kneel in prayer: in the action I raised my eyes involuntarily, and started as if electrified: fancy had drawn the picture true to the life! There

was the same sweet face with dark soul-full eyes—the same massive bands of brown hair that lent a classic beauty to the faultless features—and the same form of harmonizing grace. Nothing was wanting to complete in the flesh, with startling truthfulness, the picture fancy penciled on my mind. Who can explain this weird exhibition of clairvoyant power? In a state bordering on bewilderment I sat until the close of the service, and to be satisfied that imagination had not tricked me, I sought another glimpse of that marvelous face. It was no delusion. Supporting a middle-aged lady, whose feeble steps denoted the invalid, and leading by the hand a handsome boy of five or six summers, she walked down the aisle just in advance of me. There was no mistaking the relationship of that group, so striking was the family resemblance they bore each other—they were mother and children. I had seen the lady and her boy before, and had been struck with the blended expression of suffering and resignation that sat upon the wasted but still beautiful features of the former, and had admired the large bright eyes and curly locks of her son; but the passing interest then excited, now that I had gazed upon the witching face of the daughter, assumed an intensity quite unaccountable.

Upon making some guarded inquiries next morning, I gleaned the following short but sad history of this interesting family:

"Ten years ago," said my informant, "Henry Reed was the most successful merchant in Crampton, and yet it was said by those who knew him best, that he owed his success more to good-luck than any business tact that he possessed. This was undoubtedly the case, for the total failure of one of his reckless speculations left him penniless. By the sale of his household furniture and some personal effects, he realized a small sum of money, and with his wife and child removed to a Western city, in the hope of bettering his fallen fortunes. Broken in spirit, and possessing but little strength of character, he never rallied from the blow fate had dealt him. To drown care, dissipation was resorted to, and the once wealthy and respectable merchant became a confirmed drunkard. Nor was that all: to carry on his debaucheries, money was necessary; to raise which, in an evil hour he forged the signature of an Eastern firm, was detected, tried, convicted, and sentenced to ten years' confinement in the State prison. He never went, however; for on the morning following that on which he was sentenced, the jailor found him dead in his cell: a gash in his arm, and a pool of blood, told the tragic tale. The broken-hearted widow, with her two children, the youngest a babe, returned to her native village, where she found a home with an unmarried brother, who proved a more than father to the orphans, and left no means untried to alleviate the sorrows of his sister. Alice—for that is the name of the daughter—is now seventeen, and Crampton cannot boast of a more accomplished maiden or more dutiful and affectionate child."

To which I mentally added: And the world cannot produce so perfect a realization of my ideal of female loveliness.

A day and night of heavy and incessant rain had swollen the river until it overtopped the banks and inundated the skirting meadows, sweeping away fences and out-buildings, converting the mill-dam into a foaming cataract, and causing quite a panic among those occupying dwellings near the flood. Drift-wood went by in abundance, and the people were not slow in gathering the

harvest of fire-wood afforded them, every boat in the neighborhood being pressed into the service. The school-boys could not be controlled in such a time of general excitement; so they were set at liberty, and were assembled in flocks by the river, paddling about on rude rafts improvised for the occasion, or wading about with bared legs after truant fence-rails or voyaging hen-coops, keeping up the while such a babel of shouts and yells, as only boys can create. It was an exciting scene, and hundreds left their occupations to witness it.

Dinner was over, and I had doffed my coat for my afternoon task, when a prolonged cry of alarm from hundreds of throats arrested my attention, and I bounded to a window that commanded a view of the flood and the assembled crowd, to ascertain the cause of the uproar. One glance was sufficient. A quarter of a mile or more up the river, a skiff, containing a small boy, had got adrift, and was being carried by the out-sweeping eddies toward the middle of the rushing stream. It needed not the frantic gestures of the youthful occupant of the boat, or the wild alarm of the spectators, to tell me of his danger; for the hoarse roar of the gorged mill-dam below the village, proclaimed it in thunder-tones. It was perhaps fifty yards from the shop to the river, yet I was there in less time than it takes to tell it. I had formed no plan, but merely acted from that impulse common to us all, to aid when help is needed. But how? was the question. Half a dozen boats had put off to intercept the drifting one, but had put back in terror when they reached the channel of the stream, where the whirling tide was most furious. What was to be done? Should I stand there passively and see the boy drift by to his death? Over the dam was into eternity, with him! There was but one resource. *I was a stout swimmer.* So, ridding myself of boots and outer garments, and muttering a prayer to God for success, I sprang into the water, and struck out boldly for the approaching skiff. A yell louder and longer than the first, went up from those on shore, when I was discovered. The crowd being higher up the river than the shop, had not noticed my movements until I made the plunge. As with one voice, I was urged to turn back; it was madness, they said, to think of swimming in such a current. But to one who had breasted, for mere sport, the heavy rollers on Long Island Sound, it was not, in reality, so mad an undertaking as it appeared.

I soon reached the channel, and had not long to wait. Down came the boat like a dismasted bark driven before a gale. The boy had discovered me, and stood in the bow, his face pale as ashes, but calm, and full of mute pleading. A few vigorous strokes, and I grasped the gunnel of the skiff, and swung myself into it. The oars were in their places in an instant, and heading shoreward I bent to the work with an energy stimulated by the dread certainty that our lives depended on my strength of muscle. Wild cheers of encouragement reached us from the shore; but the nearer and fiercer roar of the dam was a better stimulant to exertion. The white, bubbling wake behind us showed speed, and the increased swiftness of the current showed the need of it. Big drops of perspiration rolled from my face, and the oars bent like whalebone. Nearer and still nearer bellowed the mad cataract—but I won the race! Two hundred yards from the brink of the dam we reached smooth water, and a score of excited men waded out to meet us, and drag the boat to land.

(To be continued.)

## Pen Illustrations of the Drafts.

For the New York Coach-maker's Magazine.

SCROLL-ARCHED CALECHE COACH.

*Illustrated on Plate XXX.*

THIS style of carriage will speak for itself. The front presents a new feature, and is a deviation from the general rule for this kind of a body, which can be turned into a crane-neck, by substituting a crooked foot-board bracket, and a round front-bottom. The scroll must be reduced or abolished in the alteration.

J. I.

For the New York Coach-maker's Magazine.

PHYSICIAN'S CABRIOLET.

*Illustrated on Plate XXXI.*

THIS kind of a carriage is very much used by physicians in London, and other cities in Great Britain. The Boston chaise takes its place in this country, but there is a great difference in the appearance of the two—this being a much richer and more expensive vehicle. The front-joints are put inside to facilitate the striking of the top to its present position, so as to render it easy for getting in and out. The knee-boot, in stormy weather, adds greatly to the comfort of the passenger. It may be opened by throwing it up against the dash, or it can be hung on slip-hinges, so as to be taken away in summer weather. There is a foot-board, commonly called a tiger, rigged behind for a boy, whose business it is to jump down and hold the horse while the doctor is making his calls.

J. I.

LIGHT PANELED-BOOT BUGGY.

*Illustrated on Plate XXXII.*

BUGGIES—can't you give us more buggies? Such have very frequently been the questions put to us since we have been engaged in this enterprise. Now, to all such importuners, we might answer, Yes; but then a larger proportion of our patrons are extensively engaged in what is designated as heavy work; and since "we study to please" all as far as possible, our friends will *please to study* the interests of the publisher, and bear with him should he not be able to please everybody. We endeavor to keep up with the times, and present our readers with every thing really new which comes into fashion; and occasionally we get a little ahead of the age, and give drafts after which no carriage has yet been built. We might find it a very easy task to crowd our Magazine with a greater variety, should we adopt the plan of seizing upon every thing of the buggy kind falling in our way; but, we are anxious to give our plate department all the features of novelty possible, consistent with practicability, and therefore prefer selection rather than profusion. However, we doubt not but that our plans might be met, and a greater number and variety of light-buggy drafts be given, in a country so extensive as ours—of practicable working drafts, should our friends manifest a little interest in this matter, and send us sketches for publication. But we are digressing.

The draft under consideration, is of a style of buggy very

fashionable just now in New York, and will, it is thought, in another year supersede the open-front bracketed body which it has been found so hard to *force* upon the public the past year. The boot is a paneled one, and when nicely painted—and it must be well painted to look nice—finishes a job preferable to every thing of the leather kind. Black is the prevailing color of painting, with very little striping. For the cushions and falls, cloth is very generally used. The roll (of leather) is sometimes trimmed after the mode illustrated on page 172 of our first volume, which makes the job look light and neat. Sometimes the seat is paneled and painted, as well as the boot, inside and out. This style of buggy, well painted and otherwise finished, we have no hesitancy in pronouncing the *ne plus ultra* of light pleasure vehicles. The best finished sell for about \$250.

## Sparks from the Anvil.

### THE SADDLE-CLIP.

THE above engraving represents a new method of securing the spring to the back-axle, called the "Saddle-Clip," just patented by Messrs. Brewster & Co., Carriage-makers, of this city.

By this arrangement no bolts pass through the axle, the spring being secured by a single centre clip, with a plate

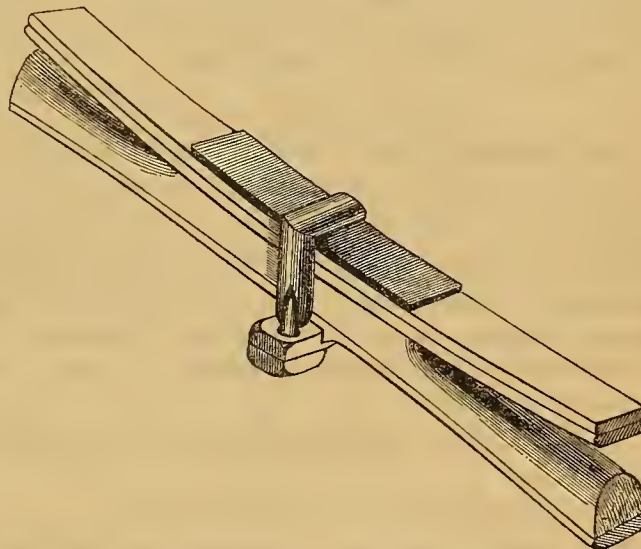

extending on either side, through which and the spring, two counter-sunk headed bolts are passed, and the nuts let into the bed; this it is claimed prevents the shifting and displacement of the spring. To give still greater solidity and strength, the "nib," or "clip bar" is forged solid to the bottom of the axle.

For road wagons, where it is particularly desirable to combine strength and lightness, this improvement will, doubtless, meet with favor—it certainly gives a better finish than in the old method of bolting on the back spring. The patent for this Clip, as will be seen from our list, bears date December 13th, 1860.

For the New York Coach-maker's Magazine.

### AN IMPROVED ANVIL-BLOCK AND DRILL.

BLOOMSBURG, PA., January 2d, 1860.

MR. EDITOR: *Dear Sir*—I have thought for some time of writing to you on the subject of carriage-making. I

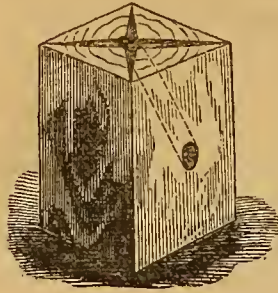

am not able to give you any educated discourse on the subject, but will give what I have to say in a good old style. I am a blacksmith, and have followed it eleven years, and have followed carriage-ironing for five years, and have found a good many

new things in the business and style of carriage-ironing. I will present you with a few, and should you think they will do you any good, they are at your service. The accompanying drawing illustrates a very good plan to keep an anvil level on the block. In the first place, bore a hole obliquely through the block, from the top in the centre to the side as represented in the engraving, and furrow from each corner to the centre, that the scales which fall from the heated iron in working, and collect under the anvil, may fall therein, and out at the hole through the block, to the floor.

The next illustration represents what is called an arrow-bit, used in drilling tires, which bores a hole and countersinks it at the same time, thus saving much labor in changing bits.

A. A. CROPLEY.

### THE THEORETICAL CONSTITUTION OF STEEL.

CARBON and iron, in combination, have commonly been supposed to constitute the properties we term steel. Mr. J. Saunderson, an English manufacturer of steel, has instituted some experiments recently, with results tending to change the generally received opinion somewhat. He says:

1st. Wrought-iron heated in presence of carbon is not converted into steel.

2d. The transformation takes place when atmospheric air has access.

3d. Pure carbonic oxyd is without action.

4th. Ammonia or nitrate of ammonia is incapable of steeling iron.

5th. It is the same with the divers hydro-carbons employed pure.

6th. But the iron is steeled when we apply, at the same time, ammonia and olefiant gas.

7th. The transformation can be effected by pure ammonia, or sal ammoniac, when a carburated iron is employed.

8th. Potassium or its vapor produces nothing, but steel is produced when ferrocyanide of potassium is used.

9th. Pure cyanide of potassium succeeds as well as the ferrocyanide; this proves that the active principle does

not reside in the iron of the ferrocyanide, from which Mr. Saunderson concludes that the transformation does not take place, except with the condition of a simultaneous occurrence of carbon and nitrogen.

He insists upon it, that where iron passes into steel, nitrogen is always found, and it is so even in cementation, that the vessels are not sufficiently tight to exclude air, and consequently, the nitrogen which it contains. In proof of this, he names the part played by clippings of hides, shavings of horns, and animal charcoal, which are frequently employed in the manufacture of steel. It is not obtained by dipping red-hot iron in pure olive oil, but is produced by fat—whilst olive oil is free from nitrogen.

### Paint Room.

For the New York Coach-maker's Magazine.

### GOSSIP FOR THE PAINT SHOP.

(Continued from page 153.)

THE preceding modes of painting may be good enough for a great majority of work, especially light work; but if you wish to give durability, and have credit for doing your work well, it must go through something like the following process:

Having your body all rubbed and dry, you must sand-paper, and dust off cleanly. Then take dry lead and mix it stiff with one part boiled oil and three parts turpentine, and with a piece of sugar of lead well pulverized, grind very fine; thin with turpentine (but with very little), and give a nice, even, smooth coat with a good, well-worn bristle-brush. Leading a body at this stage is something different from priming, and requires to be done with great nicety. It should be ground as fine as possible, and no brush-marks should be perceptible after being laid off. After standing, say, twenty-four hours, or as soon as the lead is dry, the body should be thoroughly examined, and all imperfections in the surface attended to with good hard stopper, prepared as before directed, remembering not to use more than is absolutely necessary. Still, every little bruise or scratch perceived with the naked eye, should have a little finely drawn over; after, say, two more clear days, or any time your lead is dry, the job should be once more gone over with block pumice-stone, which is termed "facing" it. If you give your lead a sufficient time to dry, and it rubs good, you will soon see the difference in the surface, and to prevent your stone from clogging or scratching, the lead should dry with a nice, crisp, hard surface, or it is questionable if the difference repays the trouble. All body-work painted in England is faced, from the Farmer's Whitechapel or dog-cart to the state coach.

From the directions accompanying the English filling, the painter would infer that it requires no facing; but I have not yet seen the surface but what would be greatly improved by the operation. It need not be done all over a body; such places as the roof, the bottom, and inside of doors of coaches, might be exempt. You have to consult your own judgment as to when it is rubbed enough; but most of the lead should be taken off, so that what remains, only fills the defects of the first rubbing. After having rubbed and washed your body clean, it should stand a certain time to dry; for should you chamois it ever so drily, there is always a dampness remaining in the corners

of the panels and around the edges of the mouldings, which require some few hours to dry. When dry, go all over with the finest of sand-paper, and dust cleanly, and you have then a very good foundation for your color, but not of the best; for to make your job unexceptionable, the process should be partly gone through with again: that is, lead mixed the same as the last, and a smooth coat given. After this is done, and it becomes dry and hard, it should be looked over with stopper as before, and all blemishes in the surface attended to. When dry, the stopper alone should be rubbed down with block pumice-stone, and the other parts well sand-papered with the finest paper. This done, you can now say you have a foundation independent of your rough stuff, and one you may depend upon, if the stock you use afterward is good, and you give it a reasonable amount of time to dry. All this is what you may term extra work, and would take from three to four days more time, besides delaying a body some eight to ten days more in the paint-room, and a great many employers would begrudge the time. It is impossible for durability and dispatch to go together in coach-painting; you are compelled to exhaust a certain amount of time to finish your work to satisfaction.

Having now got through the dirtiest part of the work, it would be well to look to the inside of your body. You have, perhaps, been careful of letting your dirty water fall upon the canvas, but you cannot avoid the inside getting in a dirty state. We suppose the canvas has been painted once, and most likely with offal paint—better put this on than nothing; but come to examine the principle and the object it was put on for, I cannot see why the inside paint should not be as good as the priming. If it were done right, it would be equally as good, and as your body has to stand around the shop some time before the dirt can be hid by the trimming, it will most likely be suspected by customers; and if sold, or so ordered by the owner himself, give it a clean coat for appearance's sake, at the same time adding a little more to the preservation of the canvas. We will now mix sufficient lamp-black with oil and varnish-bottoms, and give it another coat, excepting such places as the trimmer wishes to paste upon. It will look much cleaner, and can do no harm; for some little regard should be had for the inside as well as the outside.

The body being well sand-papered and cleanly dusted, we shall suppose it is now ready for the color, or the ground-work for the proper color. We will now briefly allude to the most prominent colors used at the present time in coach-painting. Green, perhaps, is used more than any other color, and is not only a favorite with those who use carriages, but ought to be especially so with the painter, for it is one of the easiest of colors to spread, particularly so, as we use it. In England, we may say, all greens are made with Dutch pink, which gives the painter considerably more trouble than by using the Brunswick and Quaker greens, both of which have a good solid body in them; but Dutch pink has but little, even with the colors you add to it; therefore, it requires a foundation-coat, and as a general thing two coats of your best green; while our strong-bodied greens will make a good job with one coat of color and another of color and varnish.

As a workman, I am not sorry that Dutch pink is so little used. It would give a vast deal of trouble in repair-shops, for you cannot match it with any thing but what it is made of. The consequences are, that the touching-up

requires two coats, which draws in the varnish—and one coat of varnish will not give good satisfaction; while a very thin coat of strong-bodied color will cover well, and stout American varnish shows up good upon it, and saves considerable time and trouble. For a great deal of hack-work which is only varnished twice, and painted once a year, we know it would be foolish to use it. A very good green can be made from the common materials, and look well until brought into comparison with something better, and answers every purpose; but it is not every man that can put all the ingredients together and make a satisfactory color. You can make almost any green you wish from Quaker green, Brunswick green, chrome-yellow, Prussia blue, and best drop-black. I think umbers and reds should never be used in greens. A little yellow gives your color a rich tint, and should you make it lighter than you wish, you can counterbalance it with black and blue.

When using so many different colors to obtain one single color, the body-painter will find it to his advantage to prepare enough for the carriage, so that it gives him no trouble in matching afterwards. In making greens, I put all my different colors upon the paint-stone at once, and pulverize all up together. Guessing as near as I can as to the shade desired, I then prepare a paper bag, and put all that away which I do not wish to use for the body, painting the number of the job upon the bag. You are then sure of having the color for the body and carriage to match. It is the custom with some to have the one or the other a different color from the other, but it is not the true way of painting. No man would think of having one leg of his pants a dark bottle-green, and the other pea-green, nor the upper story of his house white and the lower one a dirty brown. The color upon bodies and carriages ought to harmonize and correspond with each other, the same that he wishes his pants to do. When using Prussian blue in gums, great trouble is often had by its rising up to the surface of the color, which causes it to look "clouded," and as a matter of course spoils the appearance of the job. I think this can be remedied to a great extent by not using boiled oil and japan, both of which makes color fat and heavy, and prevents you from laying it on as thin as you would wish, and is a long time before it "sets," and so gives the blue a chance to rise to the surface. I always prepare greens with *raw* oil and turpentine. This should be ground very stiff, making sure of having enough sugar of lead in it to have it dry good; afterwards thin with more turpentine, being cautious not to have it too thin, or it acts the same as though you had japan in it. I very seldom, in fact, have never, lately, had any trouble on this score. One coat of clear color, and one of color and varnish, ought to make a good solid color, without it is something extra light, and then you might make suitable allowances.

Next to greens, perhaps lake is the color most generally used; and so much work is painted lake, that most all painters are perfectly instructed how to work it. There is a wide difference in opinions as to what is the best ground-work for lake, but even this depends altogether upon circumstances, whether you require a light or dark shade, or whether your lake is of a good or bad quality. If you have a poor lake, it is as well to help it a little, and lay a dark brown for the ground; but if you have a superior article, with a good body in it, then I think best drop-black preferable to all others, without you wish for a very light shade, and then of course you can make your ground-work

to match. I have seen lake painted upon clear Prussian blue. It gives it a rich tint, and may be very good, especially for violet lake; but that is seldom used, dark purple having the greater demand; and best black is almost universally acknowledged as the most suitable ground to lay it on.

As to the number of coats required to make a good job, that all depends upon the quality of the material employed. I used some lake lately, that was bought for three dollars per pound. I had my ground black, and tried it; it was similar to putting so much water on, not having the least body in it. I then put on a coat of brown, and afterwards put on the same lake. It was a little better, but only a precious little. I gave two coats of color, and one of color and varnish, but it made a very poor job at best. After running less than three months, you would not have believed lake had ever been near it. For the next we bought, seven dollars a pound was paid. The parcel appeared more bulky, and I suppose it weighed lighter. It worked better, was of a far richer color, and two coats upon black made a very good solid color, and of course was much the cheaper, to say nothing of piling on a body four coats of paint, where two ought to do; for after you have a surface, the less paint and varnish put on, the better. I consider every coat of varnish forwards a job another stage towards its final "smash-up;" for how often do we see good solid work cast aside, in consequence of the paint upon the body being cracked, and the carriage-part chipped into holes that you might lay half-dollars in, through its having had so many coats of inferior varnish!

Japan browns, for the last few years, have been much used in London. This is simply a little Indian red, ground very fine, and mixed in English black japan or black varnish. It makes a rich, handsome brown, and is very convenient; for every time you give your color, you give varnish. It is not a durable color, but is fully equal to a majority of lakes; for the best of lakes, with poor varnish to start with—and perhaps re-varnished with something still inferior—soon loses its brilliancy, and fades to an indifferent brown. Lakes or browns require the best of pale varnish, or they soon acquire a green cast, and rapidly fade. An excellent brown is made with best drop-black and Indian red; and if well painted, is more serviceable than lakes or japan browns. It is frequently preferred before either, especially for private work, as it has not that fiery, glaring look that lake has. It looks more modest and subdued; but to be made durable, should be put on in good oil color. Manufacturers of small work, when they wish to have work painted brown, would find this answer just as well as paying a high price for lake; for a great many painters who work in small country shops, where light work is got up for the market, "use up" a lake color, so that by the time they get through with it, it is very little better than a brown; and often, by putting on so many coats, they quickly ruin the job; but give them a good solid brown that will cover upon a dark ground with one coat, and they would make a far better-looking, and most likely-wearing job of it. If any one color is more durable than another, that color is clear burnt number; it will last as long as a body holds together, and the more it is varnished, the better it looks. It is not a rich looking color, and is not much in request, but for durability cannot be surpassed.

We cannot call blue a common color; still, occasionally

we do see work painted blue. I think it a more delicate color than lake, and requires all the attention and skill of the painter; and the best of stock to insure a good job. Ultramarine of an inferior quality, is the most detestable color to work I can possibly think of. The kind you get for one dollar per pound, must be one half flour, or whiting; at least, there is good ground for the supposition, when using it with a camel-hair blender. I will not venture an opinion as to the superiority of camel-hair blenders, and round bristle brushes; but I could always use the latter to satisfaction, and cannot recollect seeing a blender before seeing them in America. There are a great many colors which cannot be put on with blenders; in fact, all heavy paints, such as white lead, vermilion, red lead, and others, not excepting common ultramarine blue; not because it is a heavy color; but without you have it good, it works similar to flour and water, and a camel-hair brush is not strong enough to lay it off smooth and quick. It is not usual to grind it, but a good rub under the muller will do it no harm. Like lake, it should be so prepared as to work lightly; as dark japan or boiled oil would destroy its richness. Many painters have the opinion, that using so much turpentine would be injurious to its wearing, but I know by experience to the contrary. Ultramarine, which costs but one dollar a pound, has surpassed my most sanguine expectations in keeping its color. It will dry similar to distemper color; but don't be afraid—varnish will fetch it all right.

(To be continued.)

#### "OLD FOGY'S" THEORIES DISPUTED.

A FRIEND who is deeply interested in every thing relating to varnish, on seeing "Old Fogy's" articles in our columns, sent a copy to "one of the best practical painters in New England," for his opinion and views on the subject, to which a letter was returned in answer. This has been sent to us for publication, from which we make the following extracts:

"In regard to said views, I think that 'Old Fogy' is far behind Young America. His suppositions and explanations are as old as the hills, and known, I suppose, to every one who has had the most limited experience in varnishes. Let him explain, if he can, what it is that produces the smoky condition he describes, when every thing is right, and in the absence of all those causes which he supposes (but which I deny in *toto*), always exist.

"I would say nothing about the matter to any one, should varnish become smoky after being put on under such circumstances as 'Old Fogy' supposes. The varnishing done by us in our best room, to which I have previously called your attention, was where the work was in perfect order, perfectly dry, room warm, free from gas, smoke, or any thing else which would have a tendency to produce any such results. The piano-forte makers have a good experience in varnishes, and they will tell you that in nine cases out of ten, their varnish becomes smoky previous to polishing. You know that their shops are generally in good condition, fitted up for the purpose, so that varnishing can be done under the most favorable circumstances. No, sir! the trouble is in the varnish; that you may depend upon, notwithstanding all 'Old Fogy' says to the contrary.

"And again, if it is not in the varnish, why does one kind become smoky, whilst another kind, put on at the same

time, in the same place, and precisely under the same circumstances, remains bright and clear, without the least appearance of any thing of the kind? This experiment we very often try, and if 'Old Foggy' will explain that, upon his theory, satisfactorily, to any sensible man, then I will give in that he knows more than I now think he does.

"J. H. T."

### Trimming Room.

For the New York Coach-maker's Magazine.

#### A PLAN FOR THE BACK LINING OF A CARRIAGE.

SPRINGFIELD, O., Dec. 12, 1859.

MR. STRATTON: *Dear Sir*—I send you the plan for a carriage back lining, a full diamond over the swell. The foundation should be made of buckram and laid out as in

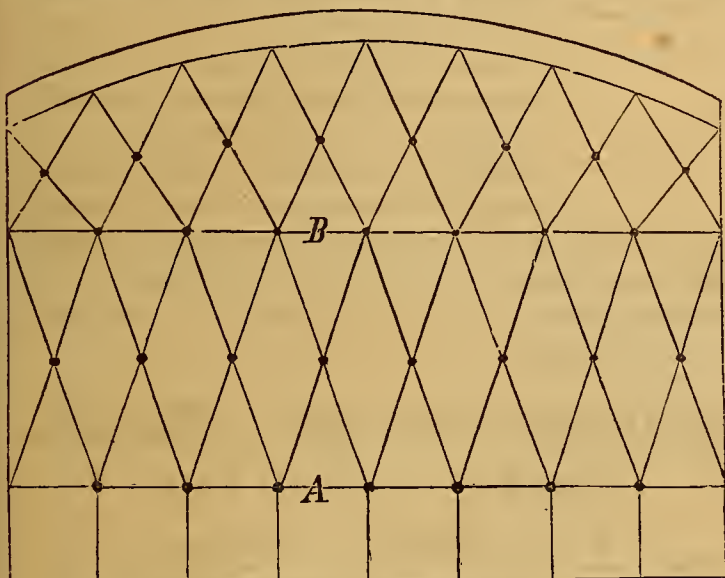

the diagram. The line A is first drawn four inches from the bottom; that at B, eight inches from the first. On a common-sized back, to form the swell, stitch a strip of blue drilling on the buckram one inch wider than the space; afterwards stuff this with hair, and take a stitch through the centre, where the buttons come.

The diamonds at the top are formed in the common way. The rolls on the buckram are two and a half inches wide. Those on the leather or cloth for the facings should be three and a half inches, with the same swell as there is on the drilling after it is stuffed. Should the rolls be larger or smaller, the same proportions are to be observed.

Respectfully yours,

R. J. BECK.

#### LIQUID LEATHER.

ON page 135 of this volume we took occasion to notice a new discovery, that of vegetable leather; and now we are called upon to chronicle another discovery, that of liquid leather. This last discovery is attributed to Dr. Bernland, of Larria, in Germany, and the properties he uses in the manufacture are said to be certain refuse and waste animal substances. For the manufacture of this leather he has established a factory near Vienna. There has not yet been given to the public any detailed explanation

of the process in manufacturing, but it is stated that the substance is at one stage in a state of fluidity, and that in that state it can be cast into almost any form desired.

For the New York Coach-maker's Magazine.

#### THE SALISBURY BOOT.

SINCE hammer-cloth dieky seats are becoming quite fashionable with us, the Salisbury boot will be found quite useful in connection therewith. In fact, it makes the prettiest and neatest foundation for this style of seat. Rounding the boot is altogether a modern improvement. They used to be made with square corners, and were paneled. There are different methods now of making them round. This is about the simplest mode yet adopted, and still it is no job for a novice to undertake. They have often been attempted by a green hand, and have as often been relinquished.

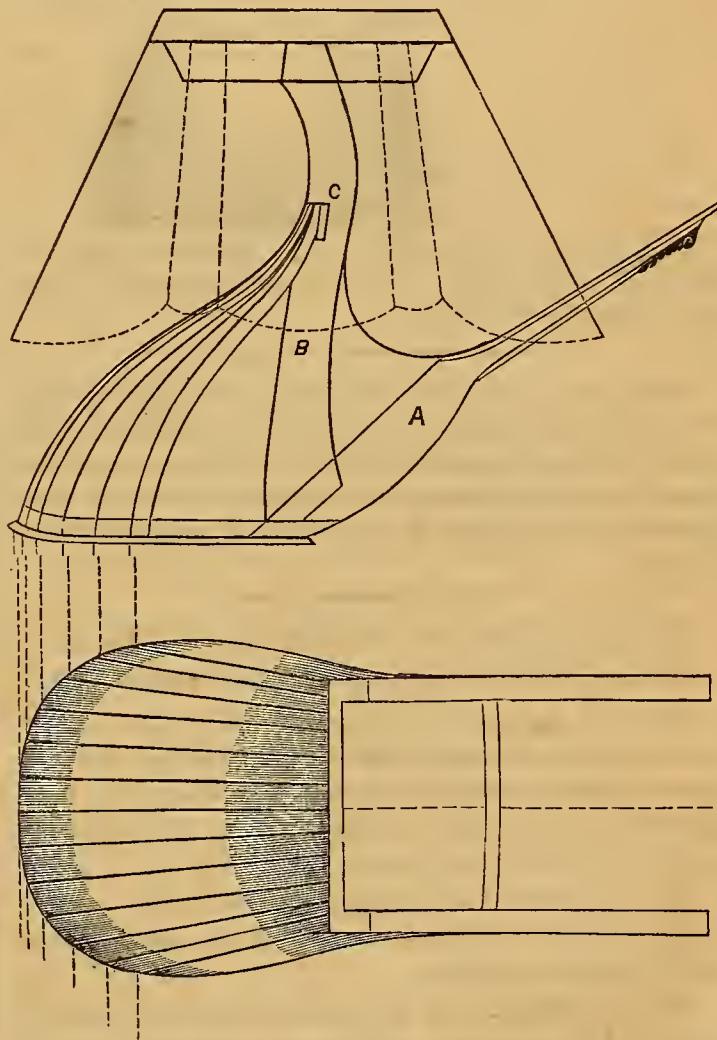

The upper part of the figure gives a side view. The bracket-piece A is in one piece, halved or framed into the bottom frame. The standard B is halved into the bracket with a cross-piece on the top, for the seat to rest on. C is where the cross-bar is framed, to which is serewed all the pieces forming the back. The graduating lines, shown in the engraving, are pieces forming the back. Each piece is of a different shape, serewed on to the bottom frame. They can be got out of pine or white-wood. The front is sometimes made round also; but I think a reasonable swell is sufficient, and looks full as well. Sometimes the boot is made by

placing pieces horizontally, the shape of the boot, one over the other, until the desired height is reached. In either case, after the boot is shaped and nicely beveled off, and got a couple of coats of paint, you must get a split hide, fresh from the tan-tub, and stretch it all around the boot, and tack it underneath and on the top, and when it has become thoroughly dry, the painters can operate.

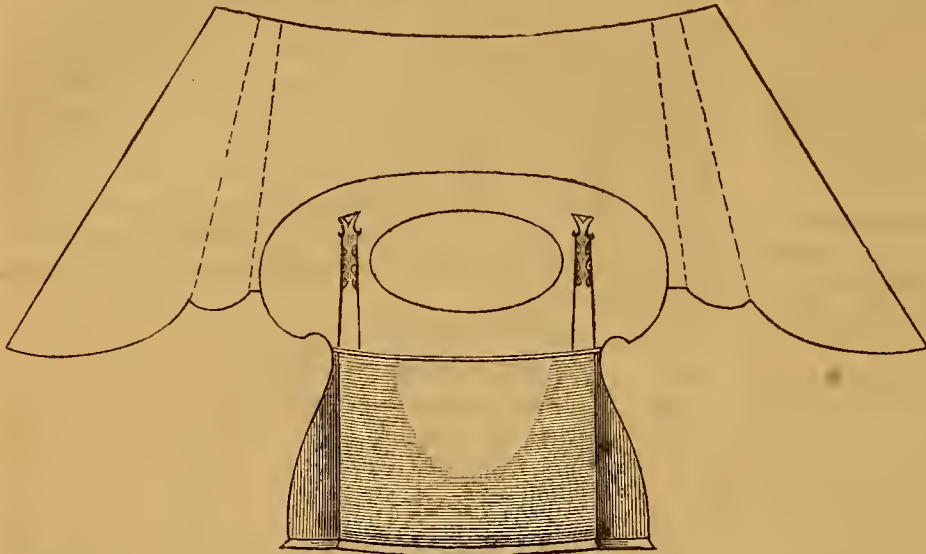

Figure 3 gives a front view of the foot-board, and the side swell of the boot. An oval moulding makes a neat finish under the foot-board.  
J. I.

**MEANS OF FASTENING LEATHER UPON METAL.**—The metal is washed with a hot solution of gelatine, and the leather previously steeped in a hot infusion of gall-nuts, pressed upon the surface, and allowed to cool. It then adheres so firmly, that it cannot be separated without tearing.

#### EXPLANATION OF STITCHING PLATE G.

*Drawn from the Designs of various Correspondents.*

Nos. 1, 2, 3, and 4, are from different designs for the corner figures of flap leather falls to buggies, and will answer equally as well for dashes, and with a very little alteration, for the sides of buggy boots also, where by custom, leather for such purpose is still in use.

No. 5 will answer for ornamenting a bow-cap.

No. 6 is a very pretty full design for the centre-piece of the fall referred to above.

No. 7 is designed for the back valance, and sides of tops, and in some cases will answer for the fronts of cushions.

In reference to the fashions in stitching and remarks thereon, the reader is directed to some observations on page 94 of this volume. What we said upon this subject in October, will apply with equal propriety now.

We shall continue to give stitching plates, as long as the wants of our subscribers require them, but it is very evident that they must soon fall into disuse; at least, as regards the finer and more costly kinds of work.

#### LITERARY NOTICE.

*The Young Farmer's Manual.*—Our worthy friend and correspondent, S. Edwards Todd, Esq., has visited the city the past month, making arrangements for the publication of his forthcoming volume, which, as its title indicates, has been written with the view of giving the necessary instruction required in educating the farmer in the diversified manipulations of farm-work, the proper choice of tools, and how to preserve and keep them in order, &c., &c. From the superficial examination we have been able to give the MS., we are led to believe that *The Young Farmer's Manual* will supply a need which cannot fail to be popular and useful. To enter into a general description of the plan of this work, which appears to possess original and practical features, not found in any work hitherto published on the subject of agriculture, is not our intention here, but we shall more in detail speak of

it hereafter, when the work comes before the public. The first volume (there will be two) will be published about the first of March next, by C. M. Saxton & Co., 25 Park Row, New York.

### The New York Coach-Maker's Magazine.

FEBRUARY 1, 1860.

E. M. STRATTON, Editor.

#### TO READERS AND CORRESPONDENTS.

**AGENCY—TO COACH-MAKERS.**—*The publisher of this Magazine, offers his services to fill orders for any article his friends may want to be found in the New York Market, FREE OF CHARGE where the individual is a subscriber. None but orders inclosing the cash are invited. Letters of inquiry, &c., must contain two red stamps.*

*The report of the long-deferred suit against the leading coach-makers of New York City for alleged infringements, in using the perch-coupling spoken of in our last number, has, we understand, been laid over in consequence of the absence of an important witness on the part of the prosecutor. We are, therefore, not able to give it as promised in this number.*

*All letters directed to this office on business, NOT relating to the Magazine, but solely for the writer's benefit, must inclose a stamp; if requiring an answer, two red stamps. Orders for a specimen number must be accompanied with nine three-cent stamps. When these terms are NOT complied with, no attention will be given them.*

*Name-plates furnished to order, of different patterns, for from \$14 to \$20 per hundred, at this office, or sent according to directions, by express, payable on delivery; to which express charges must be added.*

**A. A. C., OF PA.**—We are obliged to you for your attentions, and shall be pleased to hear from you often. You will see that a part of your communication is made available for the present issue. The shaft-stay lacks novelty.

**S. B., OF TORONTO, C. W.**—Subscribers in Canada must send with the three dollars, twenty-five cents to pre-pay the United States postage for the year, without which, the Magazine cannot be mailed.



## THE CULMINATION OF GENIUS.

It always affords us great pleasure to hear of the success of our friends, but we have been particularly well pleased—in fact over joyed—to learn that “our old friend,” Shall-I-Sneeze, has become *Colonel*, and located himself in “the Great Valley of Rascals,” where he is enjoying that “air of neatness,” &c., so worthy of *high-minded* men. We had nearly lost sight of the “eritter” since his voyage to Europe (on paper), and had only heard some vague reports of his having gone off from the scene of his former greatness, between two days; but being “posted” now by an attentive correspondent, we take the very earliest moment to inform his *mourning* friends—whom he “met on the level” some months since—of his whereabouts. We have no doubt but his “old friends” will greatly rejoice to find that the *funds*, so confidently invested in the Colonel before he got a handle to his name, and the Pine Island farm, with its other “fixin’s,” have suddenly “riz” by a single stride, from *below nothing*, as recently quoted.

But hold on! We believe *The Capitol City Fact* is the same *veracious* print that, two years ago, indorsed “our friend” as being “a high-minded and enterprising citizen, and one who deserved the support of his brother mechanics for his unceasing efforts for their benefit.” As in the former instance, this last indorsement may be “all gas” also, and is therefore to be taken *cum grano salis*. Those who have sent their *tin* “west of the Alleghauies,” to the Colonel’s address, and not since heard the ring of their “threes,” had better institute the proper inquiries of the other Colonel, and see if he can enlighten them on some other mysterious transactions of his quondam friend in the game of humbug, before they visit that Pine Island Farm, occupied by the worthy successor of “the notorious Yocum.” But here is our correspondent’s letter, and the “astounding account” inclosed, except that we have Anglicized the name from the French, as being more *sonorous* in English:

COLUMBUS, O., Jan. 2d, 1860.

FRIEND STRATTON: *Sir*—I send you the inclosed clipping from the columns of the *City Fact*, published here. It is the most astounding thing I have read lately, and will well repay the trouble of perusal. The prefix, “Col.,” is *good*, so is the “library,” and above all the “air of neatness, refinement,” &c. As for the “Plow,” that is utterly beyond *my depth*, so I will venture no comments thereon.

Your friend,

S. J.

(From the *Capitol City Fact*.)

We have been favored with the perusal of several articles in the Galveston (Texas) *News*, relating to the Pine Island Farm of Col. C. W. Shall-I-Sneeze, formerly of this city, and his newly-invented steam-plow. The Colonel has an enterprising as well as an inventive genius (!), and we hope will meet with success with both his farm and plow.

A correspondent of the *News*, writing from Beaumont, Texas, states that the farm embraces the tract of land originally granted to the notorious Yocum, who occupied it for many years, and was finally murdered, and all his improve-

ments burned, by that lawless band that invaded that part of the country many years ago, and known under the cognomen of “Regulators.” It is situated in a prairie, whose strange combination of islands of timber, with the prairie, makes it one of the most beautiful locations to be seen in any country. With the beautiful improvements the Colonel is putting upon the place, it must be envied to him by every one who sees it. The finest and most extensive family library in the State may be seen in the Colonel’s residence, and in short, every thing in and about the place has an air of neatness, refinement, and comfort rarely to be met with.

Colonel Shall-I-Sneeze’s new Steam Plow, it seems, is quite a recent invention, but one that promises to supply a great desideratum in steam-plowing. It embraces every thing that can be desired in the working of a steam-plow. It will be so constructed that it can be worked in old cultivated soil as well as upon the prairie sod. The following description of the Colonel’s invention we find in the correspondence of the *News* above alluded to:

The whole length of the machine is about 17 feet, by 8 wide. In front are two wheels [there was *only* one in front of that *Equirota*], 3 feet in diameter—12 inch face, and 5 feet tread, working directly under the frame-work of the machine. These wheels are attached to an axle, connected with the steering apparatus. Back of this is the perpendicular boiler [we wonder if the *same kind of steam* drives the plow, that served as motive power for the “Pioneer”], on each side of which are the wood or coal-boxes, and in the rear of the boiler, above the plows, is the water-tank. Immediately back of the boiler are 12 plows, that are designed to cut 12 inches deep and the same in width. These plows are attached to a crank shaft (of sufficient strength, and extending across the machine) in a spiral form, so that when revolving through the ground, one plow is always in advance of the other. Back of the plows, and as close to them as their action will permit, is another crank-shaft, upon which the engine is made to operate. This crank-shaft and the one to the plows, are connected by a “connecting rod”—the same as from one crank to another in the common locomotive. The back end of the machine is supported upon a large roller, 4 feet in diameter, and 6 feet long, which is made in three sections, to facilitate turning.

## THE SADDLE-HORSE CLUB.

SOME “smart” chap, with the laudable object in view of getting everybody to straddle a horse, has got up a club in New York City, with a constitution; from which we learn that its design is to “encourage the practice of horsemanship; and the breeding and training of saddle-horses.” This Club proposes to erect at some suitable place, a large building, where the belles and beaux of Gotham may keep horses for the saddle at a low figure, and in which building they may practice horsemanship, either in wet or dry weather, to their hearts’ content. This constitution also provides for semi-annual public competitions for premiums, to be awarded to the most expert horsemen, and for the best-trained horses. A cotemporary warns us of the danger to our craft, in the following significant words: “With the facilities which the Central Park will afford for saddle exercise, and with the impetus which this Club must give to the equestrian tendency, already strong, we shall hope

that our belles and beaux will return to the first principles of elegant flirtation, and that the re-invigoration of the race of New Yorkers, *now rather prone to luxurious upholstery in their carriages*, as well as in their houses, will be insured." For the interests of coach-making, we propose that a "Coach-maker's Protective Union" be organized forthwith, in order to check any such *dangerous* tendencies. We would respectfully submit a clause to be included in its Constitution and By-laws:

*Whereas*, the tendencies of this age, and especially that of the Saddle-horse Club, recently organized in this city, are inimical to our profession, and calculated to subvert our best interests, under the specious pretense that riding on horseback is conducive to health, therefore

*Be it Resolved*, That every member of our Society is expected, not only to promote his own personal interests, by selling to everybody all the carriages he possibly can; but, while doing so, to use his best talents in impressing upon the public mind the fact, that the riding upon horseback is dangerous to limb, subversive of the best interests of science, and *positive evidence that we are retrograding into the deepest barbarism of a primitive age!*

#### A TEXT WITH COMMENT:

B\*\*\*\*\*, O., Jan. 3d, 1860.

MR. E. M. STRATTON: *Sir*—Please send me a specimen number of your Coach-maker's Magazine, with your terms, and direct to J\*\*\*\*\*N\*\*\*\*\*, as above. If I consider it worth the money, I will send for it.

Yours, &c.,

J\*\*\*\*\*N\*\*\*\*\*.

The above *text* is a specimen of a host of letters we weekly receive from patrons of doubtful sincerity, and of which we have too many already. We would inform all such that we publish the best Coach-maker's Magazine in the world, "at an enormous expense," from the profits of which, we are trying to get an honest living. We have had about forty just such *profitable* calls during the first week in January. Now we would simply ask J. N., and his *confrères*, how many *such* customers it will take to make a publication pay? No, gentleman; "you can't come it," until we get twenty-five cents in stamps, or cash. We *consider* the numbers are "worth the money" asked by us, and are not disposed to run the risk of trusting to the "considerations" of such friends, for remuneration.

#### FAMILIAR LETTERS FROM THE CRAFT.

SUGAR BRANCH, IND., Dec. 18th, 1859.

MR. EDITOR: *Dear Sir*—It has been some time since I last wrote you, and the reasons for this delay are numerous. One is, that I have been very busy during the fall; another, that I have done some running around; and the last is, I got kind of negligent. During the fall I attended several fairs;

among them was our Indiana State Fair, held at New Albany. There was a fine show of stock, and every thing else, except carriage-work.

The carriage which took the twenty-five dollars premium was a light Rockaway, designed for one or two horses, with a turn-over seat in front. It had been varnished on the Saturday evening previous to the Fair, which opened on the Monday following, and with English varnish too! It was well *ornamented* with finger-marks, and standing in the rain, unsheltered. It rained almost every day during the Fair. The general workmanship about it was tolerably good.

The next job that attracted my attention was a phaeton trimmed with bow-leather, and painted a light lake color, and polished; but when I saw it, it was a sorry sight. It looked as though it had been polished with soap and sand, in the same way that my mother used to brighten up her tin-ware. Why, I could see the scratches on the panels at a distance of one rod very easily, and the ornamental figure on the back-panel was not in the centre thereof by an inch and a half. The iron work was very common. The gentleman who had it in charge, "blowed" it as being a number-one job, but the man that could not see the scratches in the painting and the ornament out of centre, could not tell the difference between green and blue.

There were two varnished hickory jobs, one of which was a light no-top buggy, with McClelland's self-adjusting springs, and a round body similar to the one I wrote you about last fall. This buggy took the first premium. In the other varnished job, the frame of the body was made out of white ash and maple, and the panels out of black-walnut. This was a tolerably passable job.

The next vehicle was a light calash-top buggy, with Hayden's improved patent wheel. The work on this was very common. It was trimmed by a harness-maker, and who, by the way, makes a very good *stagger* towards trimming. This buggy took the second premium.

The above carriages, together with some common spring-wagons, were all made in Indiana; but the nicest and best finished job on the ground—so admitted by all carriage-workmen—was a light shifting-rail job from Louisville, Ky. But these Agricultural Fairs are bad places for exhibiting work (and, by the way, carriage-makers are finding this out), for *the man* gets the premium and not *the work*. The last job named was a fine one throughout, except that it had a little too much dish in the wheels; but it stood no chance at all.

The following observations from carriage-makers will serve to interest you. A body-maker observes: "That phaeton looks well, don't it?" His "chum," a gentleman painter, says: "Yes; that ornament out to one side, and them scratches, *looks well*." And then a man of iron and coal declares: "That is the hardest ironed job here!" A trimmer standing by, observes: "Bow-leather looks well in that job, but it will crack so like mischief."

And then again (pointing towards the shifting rail-buggy) the painter says: "There is the best painted job I have seen yet." "And that is the nicest set top, too, by all odds," observes the trimmer. "And I can beat all such setting of tire as them," says the man of coal and iron; "why, the man that put them on must have been on a bender, or else he would not have dished them wheels so much." And in the same breath, turning to the painter, he says: "There's a nice ornament on the side-panel." "Yes, but a hard-varnished job; and look at the gearing—why, you

can see the grain of the wood through the paint—not enough lead color on that gearing!”

It was amusing to go around among the exhibitors of the different carriages, and hear them chat. One said he brought his job there merely to exhibit the springs. Another had brought his there to exhibit the wheels, and a third just to show off the good timber and workmanship, and some others because it suited their convenience; but “*none of them were got up for fair jobs!*” One would say: “How do you like that patent wheel?” “Don’t like it at all, but I like that patent spring,” and *vice versa*; and the same of the Everett perch-coupling—some liked it, and some did not; and likewise respecting varnish—some believed in polishing every job, whilst others believed in finishing with a clear coat of varnish. But there was one painter who said: “Shust give me *English* varnish, and I nevers will bolish no shob!”

We saw one carriage-maker who said he did not make any more wooden boot-bodies. His reasons were, that “the paint was apt to blister, and that after the job had been run a short time the glue would break loose from the twist and forcing in using the buggy, and then again the sun had such an effect on the boot that it drew out the nails—then your job will need repairs.”

Another man of the drawing-knife and chisel, said he had never experienced any such difficulties during his practice as a body-maker, and that *he* would rather see a painted boot with its nice striping and ornaments, than all the fancy leather boots that ever were invented. A painter here remarked, that “black is the hardest color to paint, of any the carriage-painter has to use. He didn’t care what kind of black it was, for all kinds of black were nearly the same thing as regards their working qualities.” Another said that “red lead was the hardest color he had ever tried to use.” I might go on and enumerate a great many other things which came under my observation at the Fair, but deem it unnecessary at this time.

Had it not been that Louisville, Ky., is close to New Albany and Jeffersonville, the two last-named places could not have entertained the people. Myself, with a great many others, stopped at Louisville during the Fair, so you see we could go to the Fair during the day, and to the Mechanics’ Institute at night. At Louisville I saw some as finely finished carriages as I ever saw in my life. I also visited a great many shops, where I found them making as fine work as one could wish to see. Among the many things that are getting to be “all the go,” I might mention the shifting-rail, Everett’s patent coupling, and a great deal of varnished work, sliding seats, and light rock-aways with solid quarters. I also found a great many of the carriage-manufacturers using English varnish, and the manner of painting seemed to be a little different from that of any other place. I saw no hair-striping at all, and a great deal of the light work was painted black, with very little or no ornamental work on the panels, and where ornamented, the ornaments were quite small and very easy to paint; and just here I would remark that the objections raised against the ornaments which come to us in the NEW YORK COACH-MAKER’S MAGAZINE are, they are laid down so neat and complicated that it takes too long to color them, and that makes them too hard for new beginners. Now, it has been all the go here for large scroll ornaments, fine hair striping, and clarets of all shades are used, from a muddy brown up to a light lake. Only a few years ago, everybody wanted their buggies painted green. There was

one thing I particularly noticed at Louisville, and that was, there was a great deal of New York striping done, which looks well on light as well as heavy work, and now I believe I have said about all that is worth mentioning of this visit. I have the second chapter, on “How Carriage-makers are Made Out West,” partly written, but it will not be in time for your next issue of the Magazine.

Yours, respectfully,  
GEO. P. TINKER.

BRIDGEPORT, CONN., Dec. 19, 1859.

MR. EDITOR—*Dear Sir:*

This day by mail I got a letter  
That plainly said I was your debtor,  
Which my mind had slipped; but to amend,  
Some rhyming verses I will send.  
My muse, of late, has grown quite rusty;  
'Tis out of tune, and very crusty,  
For want of practice, or of use:  
I fear 'twill fail you to amuse.  
And as for prose, why, bless your soul,  
Not three lines could my pen unfold  
That you could read—my Dutch and Latin  
Would give you fits, my kind friend Stratton:  
But as this rhyming is my *forte*,  
When I do write, 'tis in this sort.

Now time flies on with rapid wing,  
And brings to light full many a thing  
Not written in our books of lore,  
Nor ever dreamed of heretofore.  
To sober sense, I'll condescend,  
And for my nonsense make amend,  
Nor touch the follies of the age,  
For fear of being styled a sage;  
But change my theme, and try and show  
That carriages *were made to go!*  
Some on four wheels, and some on two,  
Are daily sought out by a few.  
Audacious spirits! Will some one dare  
To ask a friend his ride to share?

Our old friend Williams, of this place,  
At sulky-building has a taste  
To please the most fastidious eye;  
And better sulkies none can buy.  
And our friend Boston—known to fame—  
Has best of laces, none can blame;  
And carriage-makers, one and all,  
When wanting stock, should on him call.  
For springs and axles, all do go  
To the Tomlinson, or Spring Perch Co.,  
Whose reputations in the trade,  
Are far ahead of all that's made.

While visiting our shops in town,  
Your Magazine I've often found—  
Was highly prized where it was known,  
As many a jour. has plainly shown.  
Now all the Craft throughout the land,  
Should henceforth take a noble stand,  
And put his shoulder to the wheel,  
And do to you the thing genteel—  
Subscribe himself. If his poor friend  
Has got “the shorts,” why to him lend,  
'Till he is able to repay—  
Which would be at no distant day;  
For every jour, to me doth seem,  
Should monthly read your Magazine,  
And contribute his mite, with care;  
Then *borrowing it* would be more rare!  
I hope another year to find  
That all the Craft are of my mind,  
And that your list will number more  
Than you e'er dreamed of heretofore;  
And as all things must have an end,  
My compliments I herewith send,  
And hope in future you will say,  
The Magazine does surely pay.

B. S. L.

KINGSTON, N. Y., Jan. 8d, 1860.

MR. E. M. STRATTON : *Dear Sir*—I observe in the January number of your Magazine, that you have commenced a subject which has caused me more trouble and expense than any other one thing. I have spoilt many good jobs, in altering axles to make the track conform to particular localities, and would say that I would willingly do any thing in my power to get an uniform track for wagons all over the United States. I would suggest that you are the man to do it, and in this wise. You know all the older carriage-makers in the United States; get their sentiments, and let them name a track according to their judgments, and then divide them up, and then give it as *the* track, and publish *that* as the standard.

Now I will show you in what condition we are here, in regard to track :

In Kingston, Ulster, co., N. Y., the track is	4 feet 6 inches.
" Marlborough, " " "	4 " 8 "
" Shawangunk, " " "	4 " 10 "
" Dutchess co., 2 ml's dist't just across the Hudson,	4 " 8 "
" Delaware co., west of Kingston, (in some parts)	4 " 6 "
" " " (in other parts)	4 " 8 "
" Greene co., (some parts), 4 ft. 8. in.	" " 4 " 6 "
" Sullivan co., " 4 ft. 8 in.	" " 4 " 6 "

And such also is the case in other places. If I want to build a wagon for a friend in New Jersey, I must track it 5 feet, and if for New York city or Brooklyn, it must track 4 feet 8 inches, and so on all over the country.

It is impossible to stop people from buying their wagons in different places, and since we all have more or less friends scattered over the country, why cannot this evil be remedied? Let us then do what we can towards bringing about some action having for its object an uniform track throughout the United States. Should we not have the benefit of such a standard in our day, perhaps those who come after us will; and I venture to say every carriage-maker would rejoice.

Yours, &c., J. T. MERRITT.

BRIDGEPORT, CONN., Jan. 11th, 1860.

MR. EDITOR :—I had been reading your last Monthly Magazine, and as I put it away choicely, my ideas took rather a sober mood, and I made up my mind I would have a chat with your readers, provided you had no objections. But as I am only going to give a few of my meditations, I will make my bow and drive on. I have taken your valuable Magazine for some two years, and do occasionally have one "turn up missing" from the post-office; owing, no doubt, to some *sucker* being posted in the drafts before I can call to get it. Now, we all know this is wrong and sinful. In the first place, it is wrong to steal, and in the second place, it causes me to commit sin in hard words when 'tis gone. Now, to remedy this vexatious evil, I think one plan to pursue is to set every jour on his thinking-seat, and let him ask himself a few questions seriously. Perhaps he has never thought much on the subject; but as a new year has just opened upon him, let him ask himself, "How much money have I wasted or thrown away the past year on foolish indulgences? How much have I spent for drinking, smoking, snuff, and physic?" Have you averaged three cents per day—and who amongst you has not—did you know this little three-cent piece will count at the year's end, to the snug sum of \$10.95? Enough to pay for a year's subscription to this Magazine, and give you a barrel of flour for your family.

Again, I am personally acquainted with a number of

jours, who have told me they average their three segars a day, at a cost of three cents each, which is *only* \$32.85 per year, which would purchase for their family as follows:

1 year's subscription to Magazine, . .	\$3 00
2 tons coal, \$12; 1 cord wood, \$5, ..	17 00
1 barrel flour . . . . .	8 00
6 bushels potatoes, 6s. . . . .	4 50
Calamus or peppermints, &c., . . . . .	35

\$32 85

Now you have plain facts and figures, which have demonstrated what you have deprived your family of, for a little self-indulgence, and with no benefit to yourselves. These are no isolated cases by any means; and if you, my readers, will only ponder over the subject, you will agree with me, that it is time to rid yourselves of these luxurious, foolish, and expensive habits, and act as becomes wise and intelligent beings.

Now, we all know what should be the first duty of a mechanic, which should be to arrive at the head of his particular branch or profession; and how few the number, in proportion to the amount engaged, succeed! Now, we can in many cases account for it only in those extravagant habits which they have fallen into, which to charge them with, they would indignantly deny. I want to see more figuring and thinking done among our carriage-makers in 1860, than they have heretofore done; and when the year shall close, if they are not a more happy and healthy set by that time, I will at once give up preaching, and prophesy no more in their behalf. And I would, as of the most vital interest, they have in this matter, advise all carriage-makers of every grade, to commence a new life from this time forward, and resolve to arrive at the perfection of their art: and as a means to procure so desirable and devoutly wished-for achievements, if you have not already done so, lose not a mail in sending your subscription at once to the Editor of this Magazine, who, we all plainly see, is sparing no expense to give us every improvement in the art and science of carriage-building.

This being the only literary volume entirely devoted to our craft, it should be an honest pride with us all, to have our names enrolled upon the subscription-book of so valuable an assistant to our labors; and I hope for our own sakes, and for the sake of all concerned, that the day may not be far distant, when that shop will not be found in our country, where the Magazine cannot be seen.

That my fellow-jours may have a happy, and you, Mr. Editor, a successful new year, is the sincere wish of

O P. Q.

AN ENTERPRISING CARRIAGE COMPANY.—The *Connecticut Journal and Courier*, says: The Phoenix Carriage Company of Stamford was started but a few years ago, by four young men, with no other capital than cheerful hearts and willing hands. At that time they did their own work, and occupied but a small shop. To-day, they give employment to nearly forty hands, and the finished work turned out of their establishment amounts to \$50,000 annually. The manufactory now embraces half a dozen buildings, some of them three-story structures. Industry and perseverance always meet with a reward.

THE STAGE DRIVER, in soliciting passengers, naturally uses the words of Cicero: *Cum in omnibus.*

## EDITORIAL CHIPS AND SHAVINGS.

A SINGULAR "PUSH-COACH."—In the gardens of the Tuileries they employ at their work a newly constructed wheelbarrow of a novel character. The novelty consists in adding two wheels as substitutes for the two legs usually employed, in diameter smaller than the one in front. The shafts of the wheelbarrow are raised at the handles so as to be on a level with the laborer's hands, so that when used on a level ground it is easily managed in carrying a heavy load. These three wheels being close together, it is easy to turn the barrow in a small circle, which is done by the simple weight of the laborer on one of the shafts, which, lifting the front wheel from the ground, leaves the barrow resting only on the two hinder wheels, rendering it as easily turned as a cart.

ETIQUETTE IN OMNIBUS RIDING.—The *Boston Transcript* has the following on the etiquette of omnibus riding. One of the Red Line of coaches was halted in Washington street, yesterday noon, and a well-dressed lady entered, and passed up the fare. On one side of the coach there were six passengers, on the other, five ladies, whose ample crinoline apparently covered the sixth seat. She cast her eyes up and down the side of the vehicle, and gave a delicate hint for the females to give her the vacant seat she had paid for. But no movement being made, the lady seated herself in the laps of two women next the door, who appeared to cover the vacant space. At this the ladies, whose moire antique was in danger of receiving some wrinkles that might disfigure their dress, looked indignant, and hinted that the position of the intruder was not at all agreeable. She was informed that if she would rise she could have a seat at their side. As the lady rose she remarked that "she took the only course she could think of to teach five women the etiquette of the omnibus."

THE AMETHYSTINE BROUGHAM.—Among the novelties of the last month is the adaptation of Perkins' patent color to the painting and trimming of carriages. Mr. Ambrose Skiuner, of Camberwell, has built a brougham painted dark lake, and picked out with the mauve color, which is effected by the process of glazing: i. e., the ground color black, and white where it is picked out; over which the mauve color is painted, with the same brush over the body ground and the picking out, so that the whole color tones; the roof is painted white, which will keep the carriage cooler in summer, while it will not interfere with its warmth in winter; the lamps are plain, and the circular glass is of the same color as the lining, which throughout, both silk and lace, was dyed at one time.

This would not be possible but for the ingenious invention of Mr. Perkins, which makes this color permanent.

MINIATURE HORSE AND CARRIAGE.—Capt. Trecartin, of the ship *Henrietta*, arrived last week from Leghorn, has on board a small specimen of a stallion. He is about seven

hands high, of a clear jet black color, perfect in shape, a beautiful smooth coat, and long flowing mane and tail. During the passage he had the run of the ship the same as would any ordinary large dog. The Captain has also a four-wheeled barouche with light red wheels, and silver-plated harness. When this turn-out makes its appearance on the Bloomingdale Road and Harlem Lane, there will be some excitement, and the owner says he will take down some of the fast trotters, as his gay little steed can go a mile within three minutes.

OLD STAGERS.—A company of old stage proprietors, agents, and drivers, who, twenty years ago, on the banks of the Connecticut, first commenced to lay aside the "whip and horn," to make room for the "bell and whistle," have recently had an "old-fashioned stage supper" at Springfield, Mass. We propose that New York "follow suit," for we are inclined to think that there are more *old stagers* here, than in all the *one-horse* towns of New England put together. Wouldn't there be a blow-out, should they do so?

A STEAM WAGON.—The *Dunleith Advertiser* says there is in that place, awaiting shipment up the river, a veritable steam-wagon, adapted to running on common roads. Its inventor, John A. Reed, of New York City, is with it. He says it will travel any common road at the rate of eight or ten miles an hour, and move upon an ascent of a thousand feet to a mile or more, easily. This last assertion is certainly very *steep*. The wagon was built at Newark, N. J., and is intended to run between St. Paul and Pembina in Minnesota.

A TURKISH EDICT.—The *Journal de Constantinople* contains a late imperial edict, which, among other forbidden practices, includes the following: "No family shall keep equipages beyond their means, and the drivers must be most carefully selected." The members of the codfish aristocracy, from *civilized* society, who contemplate emigrating to Turkey, will conduct themselves accordingly, and take heed to *their ways*.

ANOTHER MONSTER.—A curious model of a monster omnibus intended to accommodate forty-five passengers, was lately exhibited on the Boulevards of Paris.

THE VERY LAST CURIOSITY spoken of in the papers, is a wheel that came off a dog's tail when it was a waggin. The man who discovered it, is said to have *re-tired* from public life, to live upon what he owes.

SOME of the finest iron-work in the Palace of Fontainebleau, was made by Louis XVI, who was an adept in the mechanical arts, and whose turning-lathe and forge were for a long time kept in the Palace of Versailles.

THE Central Park is working a revolution among our young bloods. Fast driving, in buggies, will probably soon give way to the more sensible and healthful exercise of riding on horseback. So says a cotemporary.

## INVENTIONS APPERTAINING TO COACH-MAKING AT HOME.

### AMERICAN PATENTED INVENTIONS.

Dec. 3. AN IMPROVEMENT IN HUB-BORING AND MORTICING MACHINES.—G. M. Atherton, of Friendsville, Ill.: I claim the arrangement of the pawls, S S<sup>1</sup>, with spring rods P P<sup>1</sup>, and arms V V, projecting from the reciprocating gate, L, for operating the same, in combination with lever M, for relieving either one or both pawls from racks, Y Y<sup>1</sup>, the whole being arranged and combined for the purpose of moving the carriage with the hub up to the morticing tool, as set forth.

AN IMPROVED TOOL FOR FINISHING FELLOES.—Charles A. Denison, of Guilford, Vt.: (assignor to A. Miller, of Brattleboro, Vt.): I claim, first, the described washer and the described iron gauge for trimming and shaping the internal surface of felloes, &c.

*Second*, The described collar gauges for squaring the external and internal curved surfaces of the felloe.

AN IMPROVEMENT IN CASTING BOXES FOR WHEEL HUBS.—Thos. Ellis (assignor to himself, W. A. Ellis, and A. D. Ellis), of Philadelphia, Pa.: I claim supporting the sand core E, between two sand-heads F, when the above parts are employed in connection with a sand-mould C, in the manner shown and represented.

Dec. 13. AN IMPROVEMENT IN RUNNING GEAR OF VEHICLES.—A. R. Bartram, of Redding, Conn.: I claim attaching the front axle A, to the bolster B, by means of the sleeves, B B, fitted loosely on the bolster and connected with the bar C, which is attached to a circle-plate or any suitable swivel connection, between the said bar and axle—when said parts, substantially thus arranged, are used in connection with thills or a draft-pole attached rigidly to the axle A, for the purpose set forth.

AN IMPROVEMENT IN STONE-LOADING WAGONS.—D. S. Fancher, of Logansport, Ind.: I claim, first, the inclined frame or bed A, and the hinged drop B, in combination with the friction rollers C C, and the windlass A B B, for the purpose set forth.

*Secondly*, I claim the receiving-table A, in combination with the clamps E E D, substantially as described, and for the purpose set forth.

AN IMPROVEMENT IN ATTACHING SPOKES OF CARRIAGE-WHEELS.—Joel Y. Schelly, of Hereford, Pa.: I claim, first,

The ferrule D, when furnished with rings A A, and applied in the manner and for the purpose set forth.

*Second*, the screw plats B, welded upon the inside face of the tire, in the manner and for the purposes set forth.

*Third*, I claim the combination of (with suitable slots made in the inside face of the tire) the bolt E, key-bolt G, and plate H, all arranged in the manner specified for securing the tire rigidly in its place upon the wheel, as stated.

AN IMPROVEMENT IN CONNECTING ELLIPTIC SPRINGS TO VEHICLES.—Jas. W. Lawrence (assignor to himself, Henry Brewster, and John W. Britton) of New York City: I claim the manner of combining and securing the back axle and the elliptic spring, specifically as described. [By an oversight, this patent, on page 169, is dated one year ahead.]

Dec. 20. AN IMPROVED WRENCH.—A. J. Bell, of Greenupburgh, Ky.: I claim the combination of the jointed lever F wedge E, and tooth E, with the sliding jaw D, and bar A, as and for the purpose shown and described.

AN IMPROVEMENT IN WAGON-BRAKES.—Robert D. Brown, of Prattsburgh, N. Y.: I claim the combination and arrangement of the brake mechanism lever E, and connecting rod F, when the latter is attached directly to the front axle so as to be operated by the backward movement of the front truck; the said movement being allowed by the slot H, in the reach or coupling bar and the roller G, in the bolster, substantially as set forth.

AN IMPROVEMENT IN HOLD-BACKS.—R. W. Carrier, of Sherburne, N. Y.: I claim the combination and arrangement of the open hold-back loop or eye, pivoted lever stop bar which has an extension or heel on its lower end, and the flat spring, substantially as and for the purposes set forth.

AN IMPROVEMENT IN STONE-LOADING WAGONS.—Nathaniel Drake, of Newton, N. J.: I claim the employment or use of the shaft D, with one more drums G, placed loosely on it—the shaft and drums being provided with ratchets, in combination with the pawls I, and the adjustable bar K, provided with the pulleys L, the whole being applied to a mounted frame, and arranged substantially as and for the purpose set forth.

AN IMPROVEMENT IN SCREW TOPS.—Wm. Foster and Robert Foster, of New York City: We claim the combination of the oblique-backed tops C, and slotted collar B, with the tapering or conical stock A, substantially as shown and described, so that on turning the collar the cutting threads of the tops will be released from the nut, and thus allow the tool to be withdrawn, all as specified.

AN IMPROVED MACHINE FOR FORMING HUBS.—William Patterson, of Constantine, Mich.: I claim, in combination with the swivel nut I, having a yielding or spring seat M, the adjustable collar L, and cutter shaft for causing the cutter to form a shoulder in the hub, in a plane parallel to the end of the hub, while the cutter is carried and fed by an inclined screw shaft, as described. I also claim the combination of the guiding spring bar I, and its adjusting screws *m n*, with the slide D, centre disk G, and cutter shaft, for the purpose of boring out the interior of the hub, and cutting off the ends of the spokes, and thereby prevent the latter from resting and pressing unequally on the box or on the exposed part of the axle, as described.

AN IMPROVEMENT IN SHIFTING TOPS FOR WAGONS.—Homer H. Dikeman (assignor to Ira Dikeman & Son), of New Haven, Conn.: I claim the shifting slide or curtain rail, in combination with the jointed bows, when the whole is constructed, connected, and made to serve the purposes designed, substantially as described.

Nov. 1. AN IMPROVEMENT IN HANGING CARRIAGE BODIES.—William Doulin, of Youngstown, Ohio: I claim, in combination with any of the ordinary springs of a carriage, an elliptic spring, G, on the reach of the wagon, said elliptic spring being constructed and arranged in the manner and for the purpose set forth and explained.

AN IMPROVED BIT-STOCK.—A. Spoffard, of Haverhill, Mass.: I claim arranging the socket, A, of a brace, with a slot, *a*, as described, in combination with a thumb-screw, *b*, and projections, *d*, or their equivalents, substantially as for the purpose specified.

AN IMPROVED BENCH-VICE.—G. A. Gray, jr., of Cincinnati, Ohio: I claim the described combination of the handle, G, loose head, F, and catch, H, with the jaws, screws, and endless chain of a parallel bench-vice.

January 3. AN IMPROVEMENT IN SPRINGS FOR CARRIAGES AND RAILROAD CARS.—Heiman Gardner, of New York City: I claim combining and arranging the coiled spring or blade, A, with the loose auxiliary semi-elliptical springs, H H, upon and around the central cylinder, having upon its periphery the recesses to receive the loose springs; the whole operating together in the manner and for the purposes described.

AN IMPROVEMENT IN AXLE-BOXES FOR VEHICLES.—Isaac Hallway, of New York City: I claim, first, an axle-box arranged with chilled cast iron balls, D, to fit into a cap, C, together with a groove, A, in the axle, A, an oil-hole, R, in the centre of the cap, C, and quadrant recesses, G, in the inside of the sleeve, substantially as and for the purposes specified.

*Second*, The arrangement of the recess, D, in the flange, E, in the front edge of the axle, A, substantially described, for the purpose of facilitating the operation of putting in and taking out the balls, D.

IMPROVEMENT IN HORSE HARNESS.—John Rouse, of Port Gibson, N. Y.: I claim the double-eyed hook, D, arranged and described, in the yoke-ring C, so as not to be withdrawn therefrom, in combination with said ring, and with the divided hame straps, E E<sup>1</sup>, which are respectively secured to the opposite eyes of the hook, for the purposes specified.

**A. R. VAN NEST & CO.,**  
50 Warren & 120 Chambers Streets, New York,

MANUFACTURERS AND DEALERS IN

**PATENT AND ENAMELED LEATHERS,**  
ENAMELED CLOTHS, MOSS,

**CARRIAGE HARDWARE, AND TRIMMINGS.**

Also, HARNESS MOUNTING of all kinds.

Orders by mail will receive careful attention.

**NOTICE.**

Having concluded to close out my store in New York, I now offer my stock of

**SHELF GOODS**

AT REDUCED PRICES,

All of which I intend to dispose of before the FIRST OF MAY.

I think the above worthy of your personal inspection. I shall continue the manufacture of

**SPRINGS & AXLES**

As formerly, and shall pay particular attention to the same.

Yours respectfully,

SAM'L MOWRY, 171 Canal St.  
New York, Feb. 23, 1859.

N. B. All communications to me, must be directed to Greenville, Conn.

**POMPTON CAST STEEL TIRE.**

The above Tire has met the unqualified approval of all who have used it, welds better, and is less liable to break than any other in use. A full supply of usual sizes always on hand, or made to order any length required.

The attention of carriage-makers is also called to "Ashe's Patent Tire," of which we are the sole makers in steel. This Tire has internally a raised bead in the centre, fitting into a groove on the felloe, which acts as a key at the joints, preventing their wearing or bending, requires no bolts to fasten the Tire to the felloe, leaving that in its full strength, besides being a saving of the bolts, and the time for boring and fitting.

Please address,

**GEO. W. REID,**

Agent Pompton Steel Works.

Office, 32 Liberty street, New York.

**D. INGHAM,**

MANUFACTURER OF

**COACH, OMNIBUS & LIGHT-CARRIAGE HUBS!!!**

*Chittenango, Madison Co., N. Y.*

Makes from the best seasoned red and white rock-elm timber, Fashionable and superior morticed and unmorticed HUBS, at short notice and on the most reasonable terms. Orders respectfully solicited.

**The Best Lining Nail in Use, IS THE PATENT BASSELAIN.**

It is made by the IVES & PARDEE Manufac'g Co. To be had of all Dealers in Carriage Trimmings.

**THE PATENT TOP PROP.**

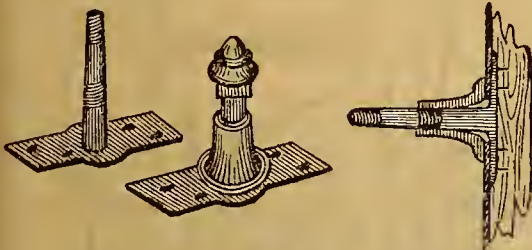

**10,000 Sets Sold**

SINCE THE DATE OF THE PATENT,

**September 22, 1857.**

The excellence of this improvement is acknowledged by all who use them. They are just what is wanted, make a perfect finish, leave the leather without wrinkles, are very strong and secure, and are sold at a very low price.

Among the many manufacturers, who use our props exclusively, are: MINER & STEVENS, New York City J. M. QUIMBY, Newark; SAROENT, GUNNISON & Co., Ameshury, Mass; SAROENT, HARLOW & Co., Ameshury, Mass.; J. CLAPP & SON, Pittsfield; ALLEN GREEN, Providence; F. L. CHAPMAN, Cambridge, Mass.; A. BLOON, Boston, Mass.

**NICHOLS & THOMAS,** West Newbury, Mass.  
Manufacturers and Patentees.

**THE IVES & PARDEE MANUFACTURING COMPANY,**

**MOUNT CARMEL,**

FACTORY AT IVES STATION,  
ON THE CANAL R. R.

CONN.

MAKE AN EXTENSIVE VARIETY OF

**Brass & Silver Coach, Carriage,**  
AND

**SADDLERY HARDWARE,**

AMONG WHICH MAY BE FOUND

- 52 Styles BANDS, of more than 1,000 sizes.
- 15 " SOCKETS.
- 6 " DASH COLLARS.
- 5 " LOOP BOLTS.
- 51 " TERRETS.
- 35 " PAD HOOKS.
- 21 " HAMES.
- 7 " BITS.

The Patent Basselain Lining Nail is manufactured exclusively at this establishment Also, the Star Screw-Cap Bands.

**SUPERIOR LEATHER-WASHERS FOR CARRIAGE AXLES.**

**W. H. SAUNDERS,**

**PATENT AXLE MANUFACTURER,**

**HASTINGS on the Hudson, Westchester Co.,**  
**NEW YORK,**

Has invented and perfected machinery for cutting and finishing

**LEATHER-WASHERS FOR CARRIAGE AXLES.**

This invention enables him to supply a BETTER and CHEAPER article than any other manufacturer. These Washers are cut from the

**HARD BACKS ONLY, OF HEAVY SIDES;**

All huts and hellies being excluded. Washers cut to any given sizes, to suit any make of Axles.

**PATENT HOMOGENEOUS STEEL AXLES,**

5-3 inch and upwards;

**Patent Homogeneous Steel Tire, for Light Wagons,**

**MINER, STEVENS & SAUNDERS' PATENT SHAFT AND POLE COUPLINGS,**

Neither of which can be had from any other manufacturer; also all styles and sizes of Carriage Axles, made from the celebrated Low Moor, Bowling, and other first quality irons, got up, as usual, in the manner which for the past twenty-seven years has secured such decided approbation.

Letter-orders, with references, promptly attended to.

**English Varnishes.**

The public are respectfully informed that F. S. DRISCOLL & CO., have been appointed Sole Agents for the United States, for Wm. HARLAN & Son's celebrated English and Japan Varnishes.  
Depot, 94 Bowery, N. Y. City.

**THOMPSON PRICE & Co,**

MANUFACTURERS OF

**COPAL VARNISH,**

No. 308 MULBERRY STREET.

NEWARK, N. J.

All Orders promptly attended to, and Shipped in New York, free of charge.

**A SINGER MACHINE,**

For Stitching Leather,

COST, \$152,

**BUT IS OFFERED FOR \$130.**

Now publishing in Monthly Parts (Royal 4to, price 2s. 6d. each),

# The Carriage-Builders' and Harness-Makers' Art Journal,

Containing practical directions in all branches of Coach-Building, with working drawings and colored illustrations. Forming  
A BEAUTIFUL SHOW BOOK OF CARRIAGE ARCHITECTURE OF THE MOST APPROVED DESIGNS AND PATTERNS  
OF ALL DESCRIPTIONS OF

PLEASURE, DOMESTIC, PUBLIC, RAILWAY, GOVERNMENT, AND AGRICULTURAL CARRIAGES,

Introducing and explaining, from time to time, all new Patents and Improvements in Springs, Steps, Wheels, Axles, and Lamps; designs in Metal Chasings, Steel and Iron Work, Silk and Lace, Carriage Furniture, &c., &c.; with an inquiry into the Combination of

Paints and Varnishes, and the Contrasts of Colors.

Including working drawings and designs in Harness-Making and Saddlery.  
LONDON: Tails & Co., 21 Warwick Square, Paternoster Row. NEW YORK: D. Appleton & Co., Broadway.

## COOK'S PATENT SLAT IRONS, SILVERED AND JAPANED. PATENT SPRING TOP LIFTERS, WITH HANDLES SILVERED OR JAPANED.

Silver Plated Dashes, Wood Dash Rails, Dash and Side Handles, Joints, Foot Rails, Steps, and Dash Rods, of any required size or pattern.

NEW AND IMPROVED PATTERNS OF CURTAIN FRAMES.

Silver Carriage Bands, of the latest Styles, and at all Prices. All Goods Warranted.



Broadcloths, Coach Lace, Curtain Fringe, Carriage Tassels, Scrim, Buckram, Enamelled Cloths, Tufting Twine, Seaming Cord, Tufts, Marshall's Thread, Jap. Buttons, Jap. Knobs, Jap. Lining Nails, Sil. Lining Nails, Sil. Knobs, Sil. Band Nails, Sil. Cap Knobs, Trimming Tacks, Lace Tacks, Curtain Rollers, Curtain Frames, Whip Sockets, Oil Carpet, Coach Locks, Iron Turned Collars, Screws, Bolts, Stump Joints, Shaft Couplings, Axle Clips, Hooks and Rings, Buckles, Lead Moulding, Chamois Skins, Silver Moulding, Sil. Calèche Trimmings, Sil. Door Handles, Sil. Rosette Top Props, Sil. Plain Top Props, Sil. Bull's Eye Props, Sil. Chased Rosettes, Sil. Chased Ornaments, Sil. Shaft Tips, Sil. Pole Tips, Sil. Neck Yoke Tips, Sil. Pole Yokes, Sil. Capped Screws, Sil. Hollow Dash Collars, Sil. Looped Bolts, Sil. Boot Mouldings, Sil. Mock Joints, Sil. Concord Handles, Sil. Chaise Handles, Sil. Inside Handles, Sil. Loop Collars, Snelle's Auger Bits, Carved Carriage Parts, Carved Bars, Carved Opera Boards, Shafts, Poles, Seats, Seat Sticks, Rug Fringe, &c., &c.  
Particular attention paid to orders for Fine Work.



**GEO. H. BROWN,**  
COACH  
**CARVING**  
In every variety.  
BACK-BOARDS,  
AND  
COACH  
ORNAMENTS,  
Constantly on hand at  
**33 Orange Street,**  
NEW HAVEN  
CONN.

**D. W. THOMAS**  
Manufacturer of  
**Carriage Name Plates,**  
90 Thompson Street, New York.

Name Plates made from sheet silver, in any shape or style of lettering, in a superior manner, at very low prices. Orders by mail will meet with prompt attention, and shipped to any part of U. S. and Canada.

**The Best Lining Nail in Use,**  
IS THE PATENT BASSLAIN.  
It is made by the IVES & PARDEE Manufac'g Co.  
To be had of all Dealers in Carriage Trimmings.





DAVID PRICE.

THEO. BOND.

CHAS. C. PRICE.

**PRICE, BOND & CO.,**  
**MANUFACTURERS OF SUPERIOR COPAL VARNISHES.**  
 No. 275 RAILROAD AVENUE, NEWARK, NEW JERSEY.

Constantly on hand a large supply of all the various kinds of Furniture Varnishes, also, White Copal (as is white), for Inside Work, Dammar, &c.

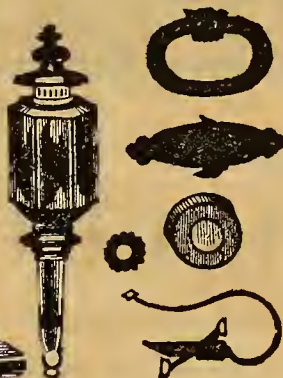
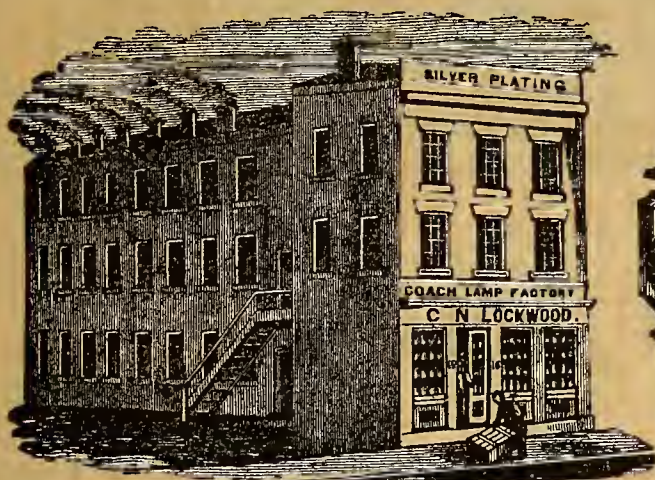

**C. N. LOCKWOOD,**  
 (LATE EAGLES & LOCKWOOD,)

**Coach Lamp**  
 MANUFACTURER  
 AND  
**SILVER PLATER,**  
 16 MECHANIC STREET,  
 NEWARK, N. J.

The Largest Assortment in the United States,  
 Embracing over 190 different sizes and patterns of  
**COACH & BUGGY LAMPS.**

**ENGINE & SIGNAL LAMPS,**  
 COACH & CANTEL MOULDINGS,  
**CURTAIN FRAMES, DASHES,**  
 RAILINGS, BRANCH IRONS,  
 Handles, Pole Hooks, Tuft Nails, &c., &c.,  
 Constantly on hand, at Wholesale and Retail

**CARY & YOUNG,**  
 No. 1 MECHANIC ST., Newark, N. J.,

MANUFACTURERS OF  
**COACH LAMPS,**  
 COACH-MAKERS'  
 Hardware & Ornaments,  
 OF EVERY DESCRIPTION,  
 CONSISTING IN PART OF  
 Coach Lamps, Pole Hooks,  
**BANDS,**  
**HANDLES, TOP PROPS,**  
**MOULDING,**  
**CALECHE FIXTURES,**  
 Rosettes, Knobs, &c., &c.,  
 Plated Dashes and Side Handles.

Coach-Makers and Dealers will find our assortment of Lamps and Ornamental Trimmings unexcelled in the United States for quantity, variety, or style.



**NOTICE OF REMOVAL.**

Newark, N. J., May 1 1888.

Gentlemen—We beg to inform you that we have removed to our new premises, (next the Inclined Plane, in Summit Street,) and that our facilities for manufacturing Hubs, of every description, are now perfect.

We have a larger stock of Elm, Gum and Oak Hubs on hand than ever before, manufactured with care, of the very best Timber; and we shall continue, as heretofore, to fill orders at the shortest notice, which our unequalled stock enables us to do with better seasoned work than can be obtained elsewhere.

We thank you for past favors, and solicit a continuance of your orders. Yours, respectfully,

**WILLIAM MILES & CO.**

Please make a memorandum of the change of location.

**THE TOMLINSON**  
**SPRING & AXLE COMPANY,**  
 Cannon St., Bridgeport, Conn.,

Manufacture Coach and Carriage Tempered Springs, Mail, Half Patent and Taper Case-Hardened Axles. We are the ONLY authorized manufacturers of E. M. Stratton's Improved Mail Patent Axles. Orders promptly filled on reasonable terms.

RUSSELL TOMLINSON, Pres't.

WM. G. LINDBURG, Sec'y. S. B. FERGUSON, Jr., Treas.

**The Best Lining Nail in Use,**  
 IS THE PATENT BASSELAINE.

It is made by the IVES & PARDEE Manufac'g Co.  
 To be had of all Dealers in Carriage Trimmings.

**PIERSON & ROBERTSON,**  
 MANUFACTURERS OF  
**COPAL VARNISHES,**  
 Cor. Chestnut St. & Rail Road Ave.,  
 JAMES PIERSON,  
 ELIAS C. ROBERTSON, } NEWARK, N. J.

Transparent Elastic Varnish for Japanners, always on hand and warranted.

# C. & D. COOK & CO. CARRIAGE MAKERS

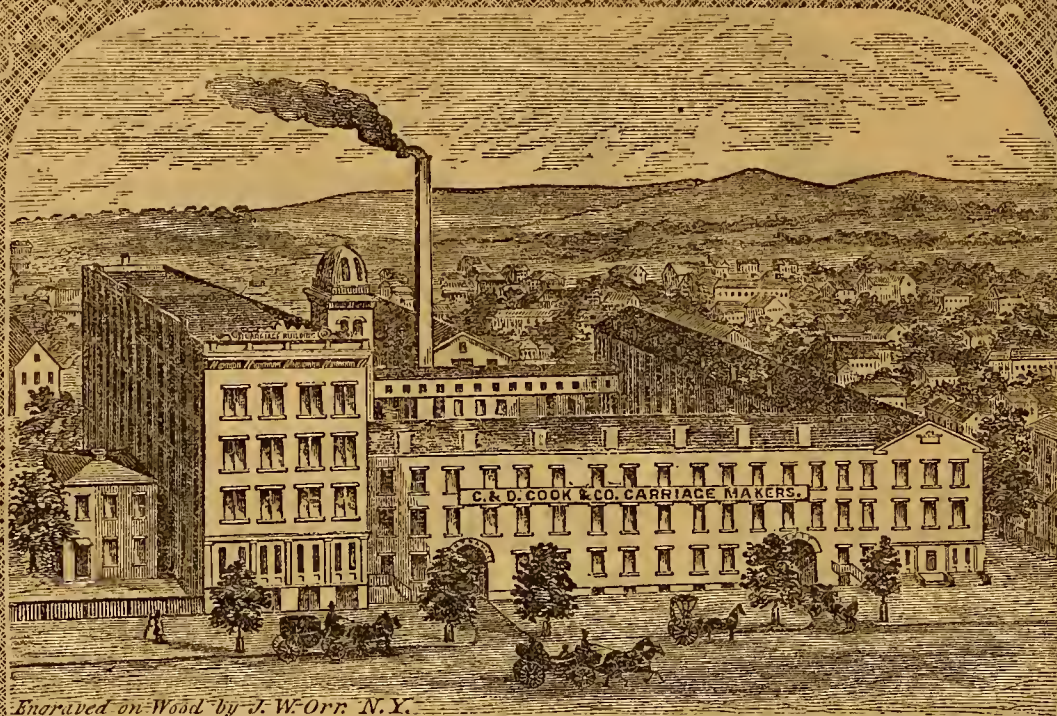

C. & D. COOK & CO. CARRIAGE MAKERS  
NEW HAVEN, CONN.

## G. & D. COOK'S PATENT ADJUSTABLE CARRIAGE SEATS.

This arrangement for adjusting Carriage Seats was Patented by **GEORGE & DAVID COOK**, of New Haven, Connecticut, February 3d, 1857.

They are adapted to almost any style of Carriage—can be used on a crooked as well as a straight body—and are at present being used extensively throughout the New England States, on light Roekaways as well as all styles of Open and Top Buggies. The peculiar merits and advantages of this invention over the ordinary sliding-seat, or in fact any other mode of adjustment, consist,

1st That the seats are perfectly secure and firm in either form, without the use of thumb-screws or bolts.

2d. They can be changed from a one to a two seat carriage, and *vice versa*, by any person, in less than five seconds.

3d. Their construction is such there is no possibility of rattling.

4th. They are so simple in their construction, that they do not get out of repair.

5th. The perfect symmetry of the Carriage is preserved in either form, so that when in one seat form, no one unacquainted with them would ever think there was another seat concealed.

6th. The manner in which they *jump* instead of sliding, is such, that in changing them the paint is not marred or scratched. In short, the simplicity, ease of construction, durability, and lightness, together with the most perfect principle heretofore introduced, must necessarily commend itself to Carriage-makers generally, and at once take the precedence of all other modes of adjusting seats now in use.

During the past two years we have made and sold over *four hundred* of the Jump-seat Buggies, and have never yet heard the first complaint in regard to their operation, but on the contrary we have many recommendations, a few of which we submit, on the opposite page. We also refer parties, wishing to know more about the merits of the *Jump-seat*, to the following persons, who have bought many of us during the past two years:

G. & D. COOK & CO.

### REFERENCES.

JAMES B. BREWSTER, Broadway, New York.  
E. M. STRATTON, Editor Coach-maker's Magazine, New York.  
G. C. DICKERMAN & CO., Natchez, Miss.  
D. E. HULL, Talahassee, Fla.  
BARLOW & CO., Canton, Miss.  
L. CHAPIN, and all other Carriage Dealers, Charleston, S. C.  
W. F. TUNNARD, Baton Rouge, La.  
OUTHWICK & SON, Galveston, Texas.

A. W. FORWOOD, Lexington, Ky.  
R. H. MAY & CO., Augusta, Ga.  
G. D. & J. G. ENGLISH, St. Louis, Mo.  
WHITTIER & POYEN, and all other Carriage Dealers, Boston, Mass.  
C. P. KIMBALL, Portland, Maine.  
SANDERS & SOUTHARD, Newark, N. J.  
DENMAN & CO., Rahway, N. J.

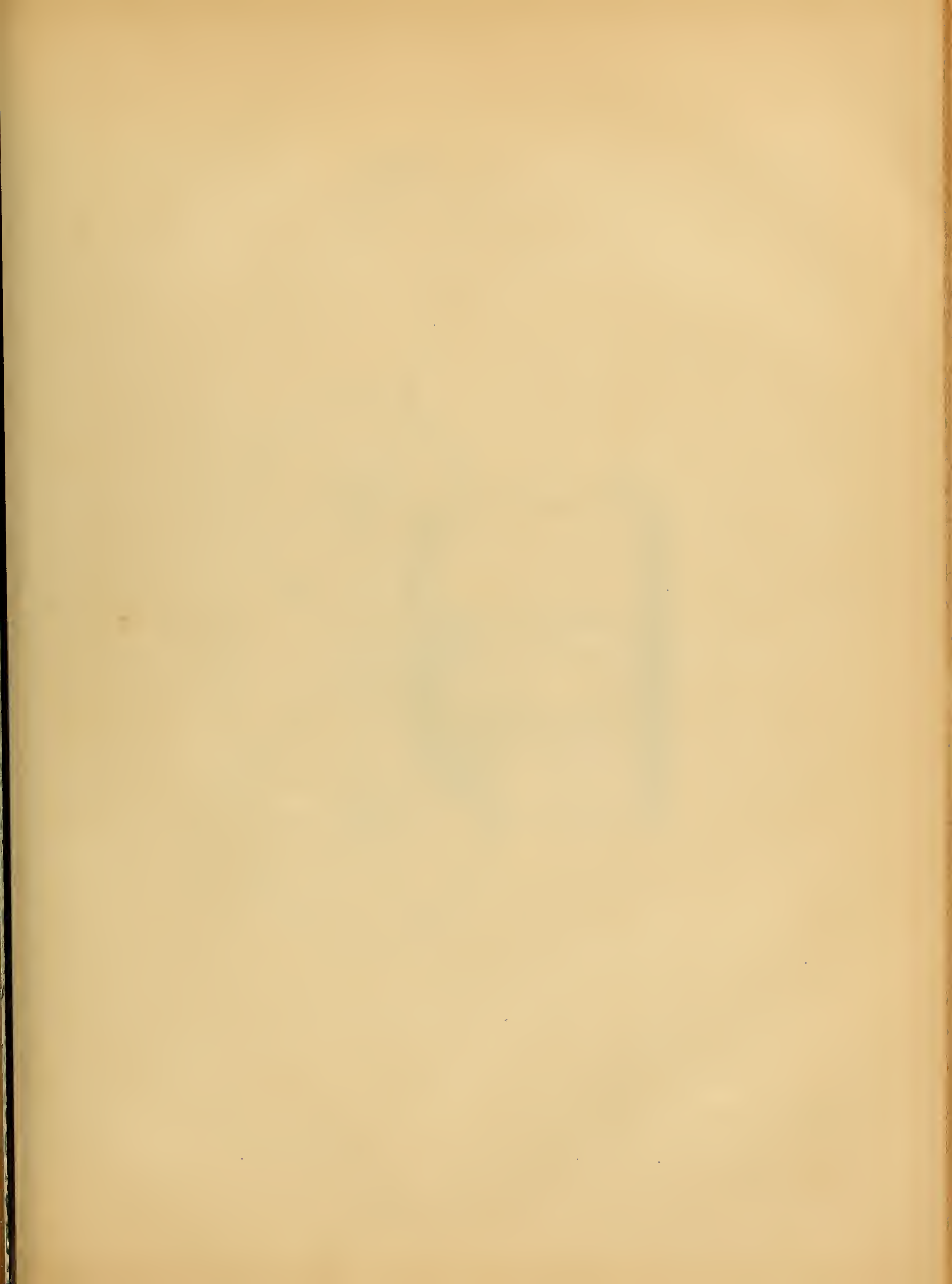

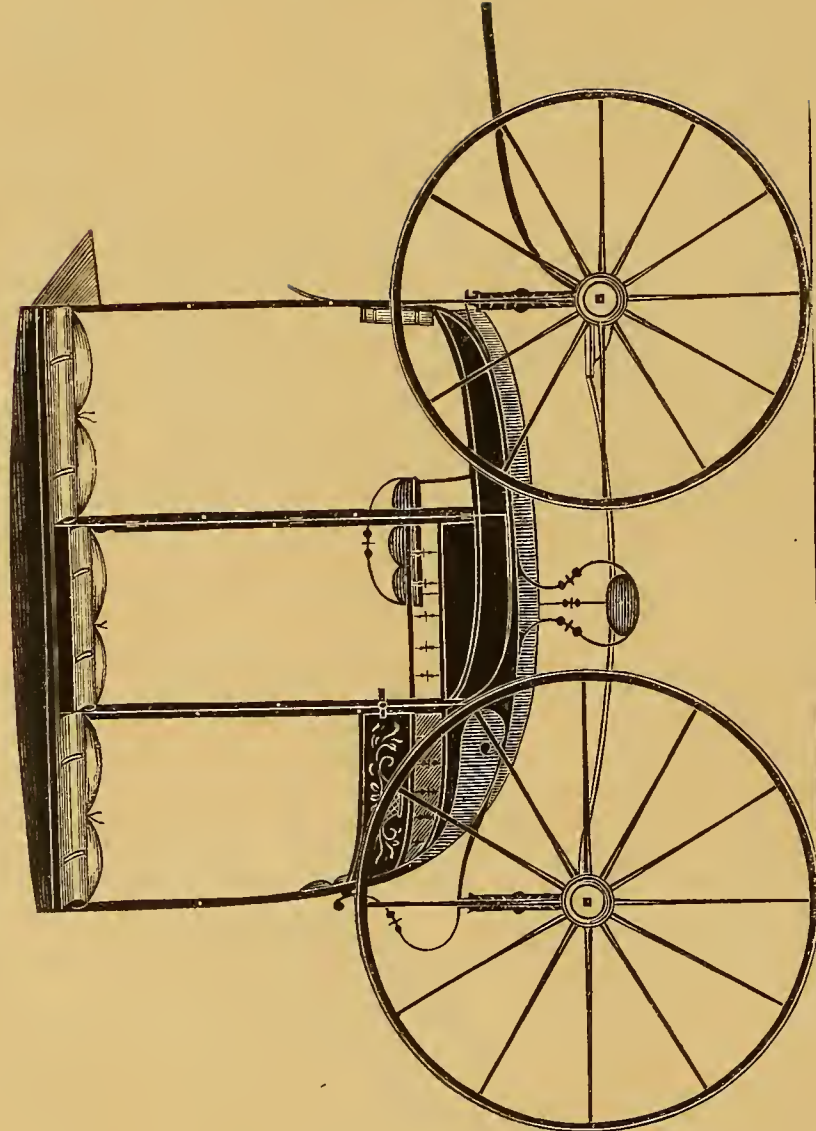

LIGHT ROCKAWAY.— $\frac{1}{2}$  IN. SCALE.

*Engraved expressly for the New York Coach-Maker's Magazine.—Explained on page 189.*

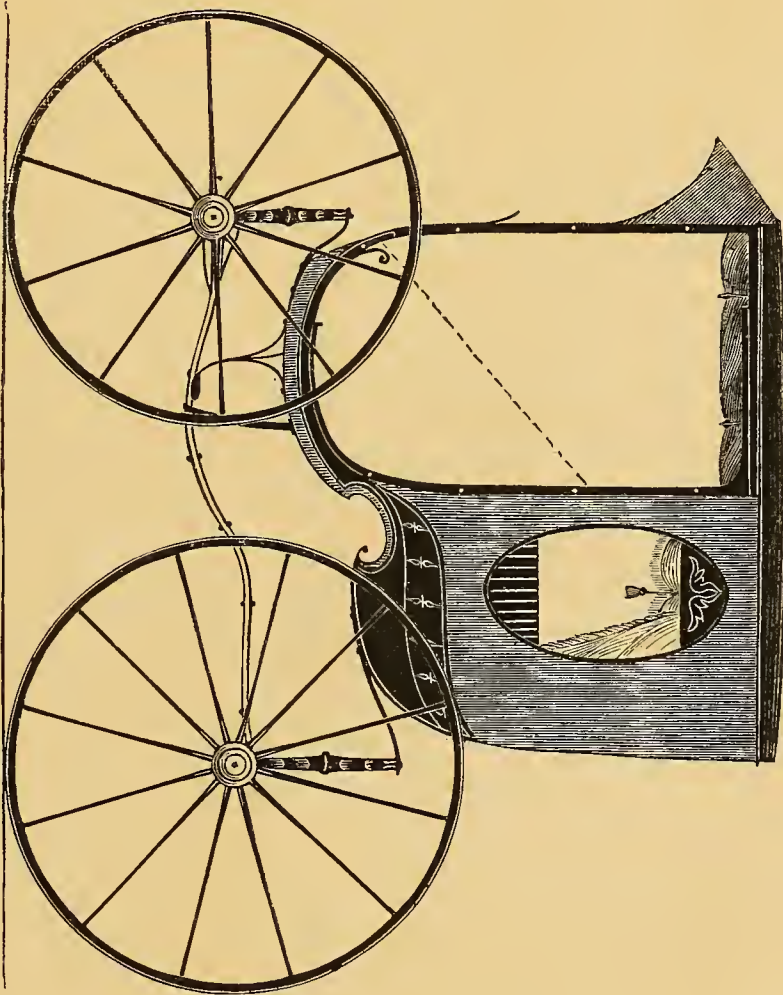

PHYSICIAN'S ROCKAWAY.— $\frac{1}{2}$  IN. SCALE.

*Engraved expressly for the New York Coach-Maker's Magazine.—Explained on page 189.*



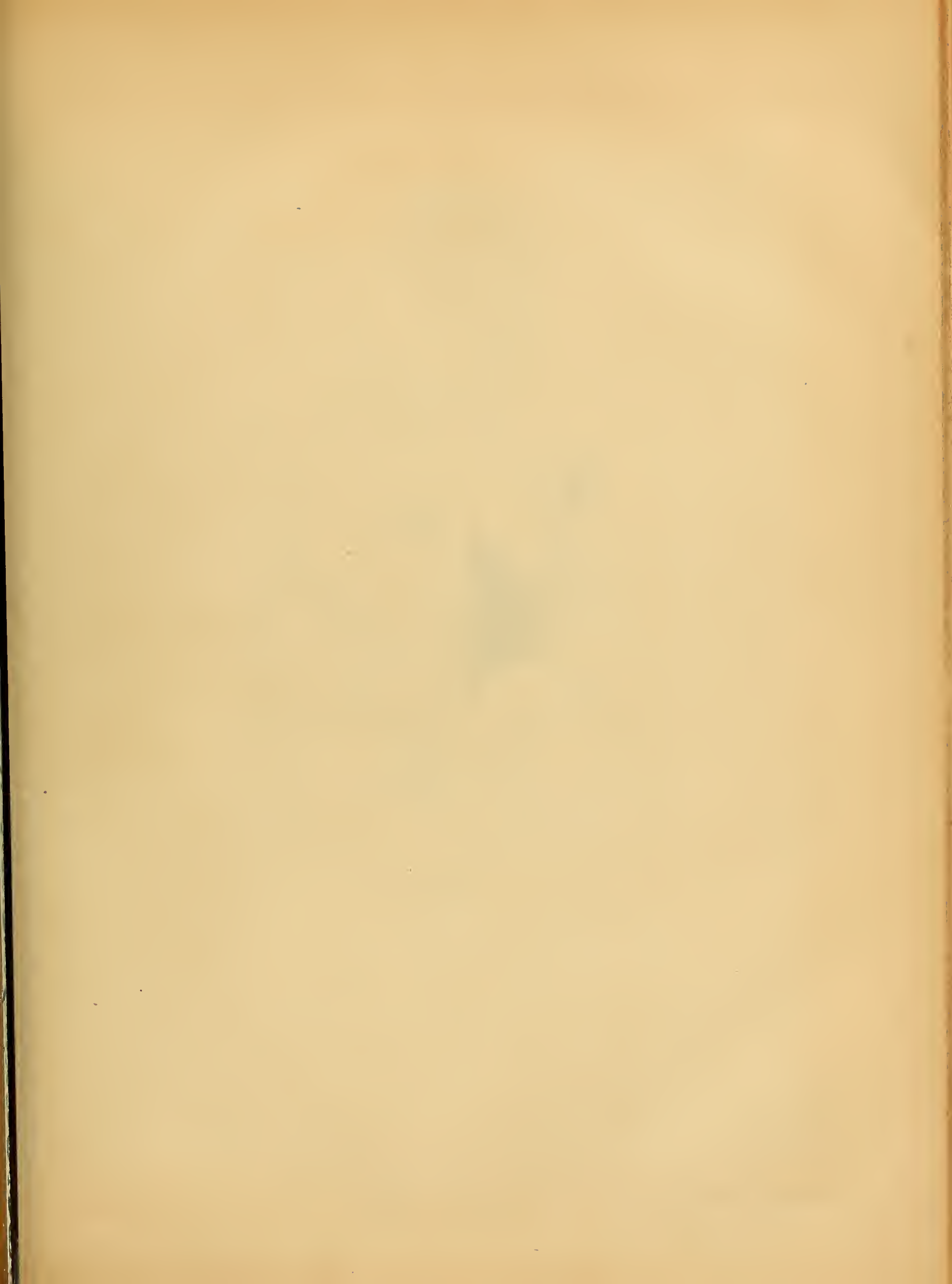

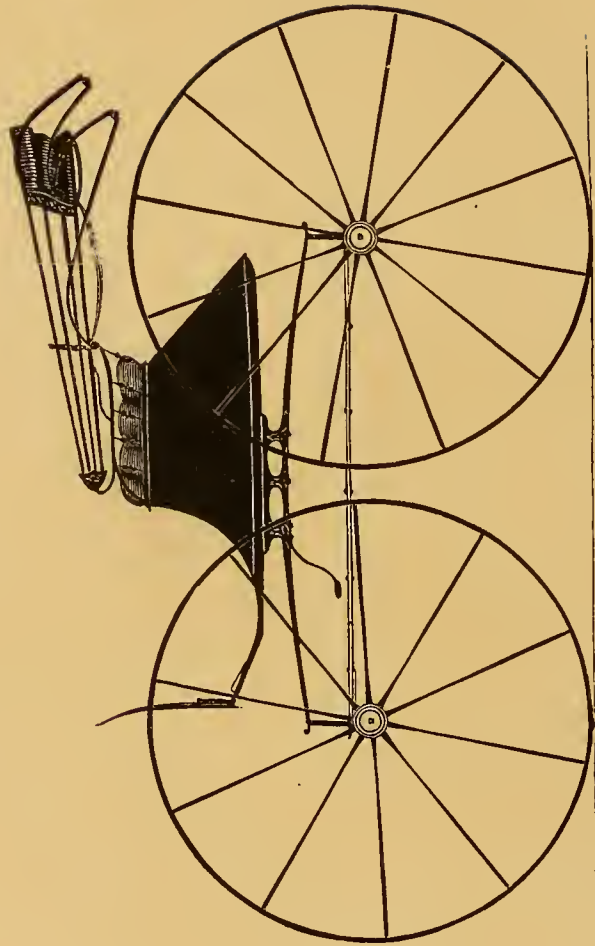

PANELED-BOOT OPEN-FRONT BUGGY.— $\frac{1}{2}$  IN. SCALE.

*Engraved expressly for the New York Coach-Maker's Magazine.—Explained on page 190.*





No. 1.



No. 2.

ORIGINAL ORNAMENTAL DESIGNS.

*Engraved expressly for the New York Coach-Maker's Magazine.*

*Explained on page 192.*





DEVOTED TO THE LITERARY, SOCIAL, AND MECHANICAL INTERESTS OF THE CRAFT.

Vol. II.

NEW YORK, MARCH, 1860.

No. 10.

### Miscellaneous Literature.

#### COACH-MAKING HISTORICALLY CONSIDERED, AND INCIDENTALLY ILLUSTRATED.

BY THE EDITOR.

#### CHAPTER XX.

The earlier emigrants to America stood more in need of carts than of carriages—Carriages thermometers for determining a nation's rise in the scale of civilization—Richard Ewstead and Richard Claydon, wheelwrights sent over to the Massachusetts Bay Colony in 1629—Under the Colonial government, carriage-making did not prosper in America—All were imported, and limited in use—Stages first used in 1693—Story of a Royal Governor and his coach—Chaises—An ancient one described.

WHEN OUR ancestors came to this land, they found it a howling wilderness, occupied by human beings, if anything more wild than the animals by which they were surrounded. Although mostly poor, they were not altogether unacquainted with the conveniences, and even luxuries, found in a community where the arts and sciences were encouraged and studied. We have, in these pages, before intimated that civilization—a higher state of refinement—and carriage-making, are found marching forward side by side in the warlike "conflict of ages" with the powers of barbarism, so that wherever a high degree of refinement prevails in a nation, there coach-making will be found in the greatest perfection. We ask for no better indication of progress in a state than that to be discovered in the architecture of its carriages; in it alone will be found a correct index to the formation of a right judgment on this subject. This we shall take as the rule; what immediately follows will be taken as the exception.

We shall assume that the original settlers of this new world came from lands where civilization had far advanced; but *they* came mostly in indigent circumstances, comforted only with the consciousness that they had expatriated themselves from all that which tends to make life tolerable, in the hope of being the better able to prepare for that life that never ends—for the hope of enjoying the liberty to worship God according to the dictates of enlightened understanding. Under these circumstances, the first care of our progenitors, on landing on these shores,

was to make provision for the body; to do which the forests had to be leveled, the ground broken up, and the seed thrust in. These preliminary labors left no time for pleasure-taking; and, consequently, the coach-maker's occupation, for the time being, was gone. Only such vehicles as the cultivation of the soil demanded were required. The pioneer of the craft, then, must be the wheelwright. It may be inferred such was the case here, from the account which follows:

Among the Company's instructions to Endicott and his council, in founding the colony of Massachusetts Bay, we find that among the artisans sent over in 1629, "There is one Richard Ewstead, a wheelwright, who was commended to us by Mr. Davenport for a very able man, though not without his imperfections. We pray you, take notice of him, and regard him, as he shall well deserve. The benefit of his labor is to be two thirds for the general Company, and one third for Mr. Craddock, our Governor, being his charges is to be bourne according to that proportion; and withal, we pray you take care that their charges who are for partable employments, whether in halves or thirds, may be equally defrayed by such as are to have the benefit of their labors, according to each party's proportion. Their several agreements, or the copies thereof, shall be (if God permit) sent you by the next ships."\*

In the May of the same year (1629), we read in the Company's second letter to Endicott, that "Richard Claydon, a wheelwright, recommended unto us by Dr. Wells, to be both a good and painful workman, and of an orderly life and conversation, our desire is, that upon all occasions he may have your furtherance and good accommodation, as you shall find him by his endeavors to deserve; to whom, as to all others of fitness and judgment, let some of our servants be committed, to be instructed by him or them in their several arts, &c."†

These men, doubtless, were the first individuals in the country to furnish the colonists with the necessary farming carts, wagons, &c., in cultivating the soil. From these small beginnings, it will be seen in the sequel that our progress has been such, that we may now boldly challenge

\* Young's *Cronicles of the First Planters of the Colony of Massachusetts Bay*, page 165.

† *Ibid.*, page 177.

the world to exceed, or even come up to us, either in the beauty, elegance, or strength of our productions, where lightness and ease are studied. We can only regret that our material for its history cannot be found in books, and that the writer has to draw his facts from the storehouse of the mind in a great measure, strengthened by a study of half a century.

While this country was a mere dependency of monarchal England, no carriages of any note were made in it, and but very few were in use. There was, to be sure, now and then one to be found among some wealthy English families in the vicinity of Boston; huge, unwieldy, and cumbrous things, adorned (emblazoned) with family crests on the panels, set off with characteristic luxury and ease, attended by liveried and officious menials, which made them odious to the sight and abhorrent to the feelings of the plainer and more modest American citizen. In Virginia, some of these "gentry" figured in their carriages in the earlier days of its history; but these, as was the case in Massachusetts, were all imported by the colonists from Europe. They who rode, and they who walked, then, may be classed as having belonged to two different orders of citizens.

Stages were in use at an early date—the first mails being carried fortnightly between New York and Philadelphia in 1693, when New Amsterdam had been conquered eleven years. Some years after, a mail stage ran, occasionally, between New York and Boston; while, as late as 1730, the post was performed to Albany on foot. As late as 1755, the "post goes twice a week" only "between New York and Philadelphia, and arrives in New York at noon on the third day." But matters had so far improved in 1774, that a "Flying-Machine" (as advertised) is started in opposition to the "slow-coach," which, it is said, carried passengers through to Philadelphia in two days—quite an improvement. The advance in the facilities for travel had no little effect on the minds of the colonists, and the "Flying-Machine," so cavalierly announced above, was but the emblematic forerunner of our American Liberties. The following account, from the *Boston Post-Boy* for Nov. 11th, 1765, will serve to show how much the "liveried" menials of "His Britannic Majesty," "who kept their carriages," were disliked about the time of which we are writing.

Lieut. Colden, who had his residence in the city of New York, and, by His Majesty's orders, was about to enforce the odious Stamp Act of the British Parliament upon her American colonies, found himself in trouble; for "the people" in their majesty "proceeded to the foot of Wall street (Fort Walls as it was then called), where they broke open the stable of the Lieut. Governor, took out his coach, and after carrying the same through the principal streets of the city in triumph, marched to the Commons, where a gallows was erected; on one end of which was suspended the effigy of the person whose property the coach was. In his right hand he held a stamped bill of lading, and on his head was affixed a paper with the following inscription: 'The Rebel Drummer, in the year 1745.' At his back was affixed a drum, the badge of his profession; at the other end of the gallows hung the figure of the Devil, a proper companion for the other, as 'tis supposed it was entirely at his instigation he acted. After they had hung there a considerable time, they carried the effigies, with the gallows entire, being preceded by the coach, in a grand procession to the gate of the Fort, where it

remained for some time, from whence it was removed to the Bowling Green, under the muzzles of the Fort guns, where a bon-fire was immediately made, and the drummer, Devil, Coach, &c., were consumed."

After the Revolution, our American patriots, among whom was our illustrious WASHINGTON, Adams, and others, kept their carriages; but, in contrast with the subjects of the British Crown of former days, they were very plain affairs. These, too, were all imported from Europe. When heavy carriages were first made in America, is not very definitely given in the histories of our country. Only the more wealthy could afford to ride in these expensive articles. The middling classes had to content themselves with two-wheeled vehicles called chaises (vulgarly *cheers*), and by some gigs. These have continued, with very important alterations, in use until the present time, and are still known as the Boston chaise. They were at first constructed very clumsily, with a heart-shaped body, with scarcely any swell to the sides, suspended without any other than long wooden springs, with a square standing-top formed of  $\frac{3}{8}$  rods of round iron, clumsy and rude, and very expensive, withal. The prevailing color of these chaises was yellow, and occasionally they were painted green, or a sky-blue. Sometimes they were ornamented very highly with heavy silver-plating. The chaise to which we have alluded as having a standing-top, was owned by our grandmother in the year 1800, and cost about 230 dollars,—a large amount of money for that day. In this she was accustomed to take her airings, and this, of itself, was sufficient at that time to confer distinction upon its possessor. Those who "went to meeting" in gigs, in our boyhood, were considered "great," because they were few in comparison with those who were forced to "foot it." These "old settlers" are now nearly all gone,—like their passengers,—to that destiny of all things—ashes. Only a few exist; we know of but one—in the vicinity of New Rochelle, Westchester county, New York, and that *only lives* because its maker, an *old fellow-craftsman*,—now dead two years,—wished to preserve it as a keepsake in remembrance of former days, when he carried on the business here. *Sic transit gloria mundi.*

There was a Coach-Makers' Society organized in New York as early as 1788, the members of which were found in great numbers in the public procession in honor of our Federal Constitution. As an account of their proceedings may prove interesting, we shall give them a little in detail. The coach-makers, in company with the harness-makers, had a stage drawn by ten horses at the head of their division, accompanied by three postillions, dressed in yellow, and jockey-caps trimmed with yellow, and four workmen on the stage at work. A flag extended across the stage, representing a shop with open doors, representing hands at work and a coach finished. At the door a vessel was represented as lying at the wharf, taking on board carriages for exportation; over the shop the Union flag; over the ship, the nine federal members from this country. In the center, the coach and coach-harness-makers' arms, on a blue field, three open coaches, supported by liberty on one side, holding in her left hand a cap of liberty, on the other side by Peace, holding in her right hand a horn of plenty, Fame blowing her trumpet over their heads; motto, "The Federal Star shall guide our Car." A green monument, supported by ten pillars, with an Union in the center; erect on the top of the arms, and an eagle soaring from a globe. In addition to the above,

the saddlers, harness, and whip makers carried in a separate department an emblematical figure of their profession: a horse decked out with an elegant saddle and harness, with embroidered tassel, led by a groom dressed in character, attended by two black boys, and a long retinue of bosses and journeymen following in their rear. From the reports of the elder members in the trade, we learn that coach-making in New York city sixty years ago, was one of the "institutions" among other mechanical occupations, and its members were, some of them at least, men of wealth and influence.

For the New York Coach-maker's Magazine.

### CARRIAGE-MAKING IN BOSTON, MASS.,

WITH A CRITICISM ON "WESTERN WORK," AND THE FINISHING AND SALE OF CARRIAGES GENERALLY.

(Concluded from Page 162.)

In most cases wheels are made by hand in Boston; and builders who pay from sixteen to twenty-four dollars for the making of a set of coach-wheels, are not expected to sell their work at the same price that others do, who pay but from fourteen to sixteen dollars for wheels, stock, workmanship, and all incidental expenses of making them upon their own premises included. The first costs are high, but prove cheap in the end, which carriage owners around this vicinity fully appreciate, and willingly pay for. As regards painting, if it does not always turn out as perfect as we could wish, it is done with the intention of its being equal to the other branches. It is all done by days' work, and the man that lays the finishing coat of varnish, very likely puts on the lead, and takes his share of rough and smooth throughout. A man that rubs rough-stuff one day, leads carriages another, and perhaps finishes a job once in fourteen days, is not expected by sensible men to have that perfect finish to his work, which men have that do nothing but finish all the time. His brushes get dirty, with standing so long unused; his varnish gets skinny and seedy; but Boston painters can always finish work so that it but seldom cracks, never blisters or peels off, and always gives general satisfaction to the purchaser.

There may be painters of more pretensions than myself, who may feel disposed to dispute the question that Western painters make a cleaner finish of their work than we do; but I am inclined to think, that where every branch is done so systematically, where every man has one particular branch, and such a quantity of work that it keeps all in full operation, such men have the advantage of small shops in the appearance of, but not in the durability of their work, which is well known to all who are constantly re-varnishing it. It is needless to say that work that is executed by experienced workmen from beginning to end, through rough and smooth, costs more than if half-made mechanics were employed upon it. The cost is fully fifty per cent. more than what the same piece of work costs Western builders. The reader needs no reminding of the difference in the wear of articles washed with silver, and the same plated with good silver plate. This is fully understood by carriage-owners who take the necessary precautions, and order their work from those builders who have more regard for their reputation than to use it.

The same comparison may be drawn between inferior and superior work, no matter in what country or in what

part of a country it may be made. The same discrimination is made between Boston builders themselves. There is one builder whose work is held in such high estimation, that vehicles constructed after his style or design fetch a higher price than any other builder's; but if his name be attached to them, they readily bring from ten to fifteen per cent. more. While other builders get ten hundred and fifty dollars, he undertakes to build no coach for less than from eleven to fourteen hundred, and in some cases fifteen hundred dollars. It is true, his business is limited, and perhaps he builds no more than a certain quantity during the year; but when they are built they will bear inspection. They are no apology for a coach; they represent what they are intended to represent—*carriage building*. He undertakes to build no coach under from five to eight months; but when you do get it, it will bear comparison with any work in any country.

Some men would be inclined to criticise, and find fault with the sweeps and general outlines of Boston-made work, and I think in some cases have good ground to do so; for when tested with a true "mechanical eye," faults may be pointed out which add no beauty to its general appearance. Notwithstanding this, Boston customers like these styles, and will have no other, and the builders can well afford to give the palm of novelty of design to builders in other parts of the country. It ought to be enough for them that they can and are building vehicles which no competition can compete with, in durability, and the satisfaction they give, which always insures customers for all that can be conveniently built; and the price obtained, though not so remunerative as it ought to be, still is sufficient to uphold the reputation of the craft, and insure to the consumer a satisfactory equivalent for his money invested. If any other proof is wanting of the surfeiting the public of this vicinity have had of cheap work, I need only say that work is built within the precincts of the city of Boston, after the style of Western work (and sold at a similar price), and while other builders' work, commands a premium, this remains almost a drug in the market.

This bringing of cheap, inferior work into competition with good, substantial work, let the price be whatever it may, can never have any permanent success. It may have a temporary advantage; but all men any way "posted up" in carriages, know that instead of paying \$100 less for an inferior, they had better pay \$200 more for a superior vehicle. I entertain no such dread of the "fell tyrant" Competition, which your correspondent J. I., in the December number of vol. I, p. 126, seems to think so much about. The fell tyrant can never do the workman any very serious harm, without he is a party to it himself. The most injury competition can do the really good mechanic, is something in this way: In almost every town, in every State throughout this great country, there are men following the carriage-making trade, that think they are competent to be builders, and carry on business upon their own "hook," when they have neither the brains, nor yet the capital, requisite; but they hire an old barn, or build what is quite as bad—a brick hovel—hang out their shingle, and take their chances of work, the same as the help they hire have to take *their* chances of pay. They have nothing more than ordinary ability, and depend upon the prices they sell at for patronage. The prices they do sell at are not remunerative; they fail to pay their help; they *fail* themselves, by which they not

only lose their own *all*, but rob the honest, industrious mechanic of his hard earnings.

Competition will never lessen the demand for carriages. If a man buys a buggy, and it turns out to have been badly constructed, he does not forego the use of one because his first happened to be a bad one. He will buy another—but not made by the same maker; but the price he paid for the first, he makes the criterion for the price of the second. He may be fooled a third time; but depend upon it, he will begin to see his error, and rush to the opposite extreme and buy one of the highest cost, which he is likely to find the cheapest in the end. Competition, as it is now carried on, may be the principal means of moving the manufacturing localities of the craft. We may take Boston as a true index for other parts of the country, which have chiefly depended upon the Eastern States for their regular supply of carriages. By a constant supply of poor (inferior) work, customers will be more disposed to encourage the manufacturing of carriages nearer home, although they may not be made with such beautiful sweeps, and finished so fancifully in detail. The consumer will sacrifice all that for durability.

Some five or six years ago, there were some sixteen to eighteen hundred machinists employed in a few machine-shops in Boston, making locomotives, sugar-mills, lathes, and all kinds of machinery for mechanical and commercial purposes; most of which was for the Southern market. Trade was so driving, that I knew tailors and ribbon-weavers, who scarce knew the use of a file, demand and receive ten dollars per week for their labor; while more competent hands were earning from fourteen to twenty dollars per week. But matters have changed since. Where those sixteen hundred or eighteen hundred men were employed, there are not more than two hundred to three hundred at the present time; just enough to supply the home demand. Those eighteen-dollar-per-week men are glad to be employed at ten, and the trade is overstocked at that price. What is the reason for this change? There is still a demand for this work, but the ravings of designing politicians, and the constant agitation and bitter animosity it engenders between different sections of the country, with perhaps a little unfaithfulness upon the part of contractors, occasioned by employing inferior help, induces capitalists to look nearer home, and have their orders completed where they themselves can exercise more supervision over them.

It is the great southwestern cities that are gradually drawing the surplus of all mechanical labor from the northern market into their own hands. You may depend upon it, those twelve or fourteen hundred machinists are not starving. The practical mechanic must and will follow labor, and face fevers, ague, and all other climatic diseases, in order to obtain it. I apprehend no such sudden collapse in the carriage business. The home demand is so great, it will prevent it; but by an excess of competition, and by constantly manufacturing an inferior article to bring it within the limits of selling at competition prices, it may in course of time take a surplus of the business now done upon Southern account, to a market nearer home; for depend upon it, the South will never retrograde in mechanical arts. The civilization and progress of the times is a sure guarantee that they will never do less to supply their own demands than what they have heretofore done; and it is for Northern manufacturers to consider whether they can and will let the Southern trade slip

through their hands; it is more to them than the workmen; for wherever carriages are wanted, carriage-makers will be found to do the work.

If there is anything to fear in the competition between capital and labor, there is equally as much cause for the practical mechanic to fear the competition between superior and inferior help; for men who claim themselves as members of the different branches of carriage-making, can be hired at almost any price; and in large manufactories, where the principals are unacquainted with the help they employ, and the men in charge have no care whether it be good or bad, a half-made workman gets along just about as well as the best. It often happens he is better thought of. The experienced, competent workman has a good deal to fear from the narrow-minded ignorance of employers, for all will admit that upon the whole "journs" bear a favorable comparison with "bosses," for intelligence, and integrity of character. There are a great many employers that can never appreciate good or bad help, no matter which they may chance to have; both are treated alike. Under all the circumstances, I would say to J. I., be of good cheer; and if you are obliged to work for men who manufacture and sell at competition prices, I would say get your pay weekly. Don't let your employers speculate with your capital, if to be avoided; and when left to their own resources, and their work tested by its true merits, they will soon go to the shady side, and make room for those who wish to make a fair article at a remunerative price, and who will carry on a legitimate business. Whatever branch you may be a member of, if you work piecework, you can accommodate yourself to the remuneration you receive. If they pay in accordance with the price they sell for, you, on your part, can do your work accordingly.

This manufacturing of work by the wholesale, and filling repositories and auction-rooms, and selling at a sacrifice, will give out sooner or later. The greatest trouble is, it too often happens that the honest, industrious employee has to share the same fate as his reckless, speculative employer. But, let us hope for the better time coming, when builders will consult the interest of all concerned, by building a superior article, and selling at a price which will enable them to pay good wages for good help. By so doing, they will encourage honest industry, and advance their own reputation as men and employers. A little more taste and good management displayed by those who build for the market, might prove advantageous both to the workman and the builder. If they would keep some of the gew-gaws off the work which often prevent its sale, and either put the money they cost in their own pocket, or divide it among their workmen, so as to enable them to bestow more pains and finish up their work better, it would be far more beneficial to the customer. A great portion of the work now offered for sale, would be more readily purchased if ten per cent. more money were asked, and a better finish given, which would return both master and workman more profit for their labor; dividing five per cent. among those men who do their work by the job, they would soon show the difference in the appearance of their work, and the remainder would enable the employer to meet his current expenses with a better spirit than a great many do.

We hear our house-wives tell stories of the sentimental "cheap Jacks" they come in contact with in dry-goods stores, who will ask a price double the market value of

their goods, and one third more than they intend to take; but I question if they are not surpassed by the carriage-selling fraternity, who have practiced it to such an extent that a customer upon hearing the price asked, immediately makes his own deductions, and fixes the price himself. This practice does serious injury to the general business. The inexperienced buyer has no confidence in that which he purchases. It would be far better if they intended to

abide by the price asked, sell or never sell, and not take twenty-five or fifty dollars less than what they may have asked. The community would have more faith in securing a good vehicle, and would have a higher regard for manufacturers, who, they would consider, carry on a legitimate, straight-forward trade, and who "ask no more and take no less, sell 'em or never sell 'em."

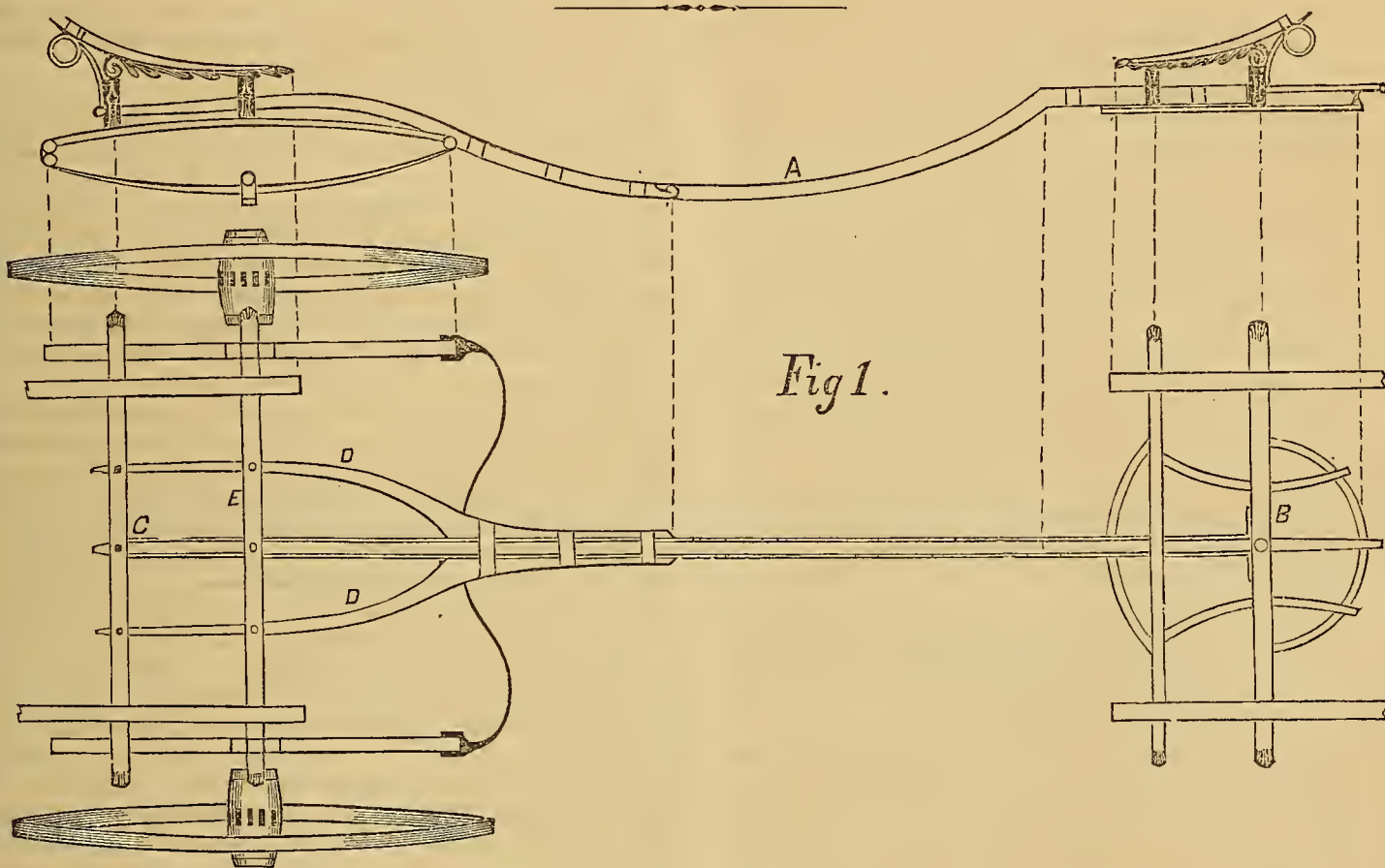

Fig 1.

For the New York Coach-maker's Magazine.

GEOMETRY OF CARRIAGE ARCHITECTURE.

BY A PRACTICAL COACH-MAKER.

PART TWELFTH—CONSTRUCTION OF THE CARRIAGE PART.

This kind of carriage-part is the most difficult to make of any, and requires the greatest amount of study and calculation to combine strength with lightness. It would be useless in this place to lay down a rule for direction as regards dimensions, as each carriage must be suited to the body for which it is designed in strength and proportions, width of track, height of wheels, &c. The perch A must be a solid piece of work, with iron plates on both sides and on the bottom. The side plates must be cornered on to the head transom B and there bolted, and extend into the mortice in the cradle-bar C. The wings D must range with the perch. They are fitted to the side, against the side-irons, and there banded on with three bands as shown in the diagram. The transom B and back-bed E must be clipped on to the mock-spring. We design to give the principle of the mock and C springs, in a future number, on a larger scale.

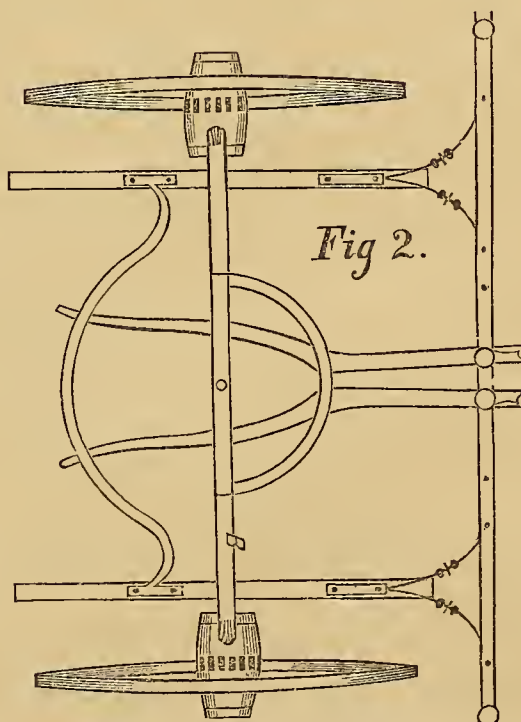

Fig 2.

For the New York Coach-maker's Magazine.

### RALPH LONG'S STORY.

BY JAMES SCOTT.

(Concluded from page 168.)

As I took the boy in my arms and sprang on shore, there was a swaying to and fro of the crowd, and many voices shouted, "Make way! stand back! here comes his mother!" Two ladies now issued from the throng, and bounding to my side with frantic cries of delight, clasped the boy in alternate embraces and greeted him in terms of touching endearment. As my eye dwelt upon the group, a thrill of blissful surprise shot through my frame—they were Mrs. Reed and her fatherless family! Oh! how wildly my heart throbbed at the discovery! But why? Was it because the consciousness of having done a meritorious deed eased my sin-burdened soul of a moiety of its load? No! had the boy been the son of my Irish washer-woman, such would have been my state of feeling; but one glance at the tearful face of the beautiful girl before me, strongly suggested a different cause—he was her brother! This fortunate adventure, I soliloquized, will bring me to know her—to gain her friendship, perhaps—but no, I dared not hope for more. The voice of a shop-mate aroused me from these, but too pleasant thoughts, and I hastily left the spot.

"They didn't even thank him," I heard a voice say, as I passed a group of persons.

I could have strangled the speaker on the spot. Thanks, indeed! Bah! what cared I for thanks given in the presence of a gaping crowd of villagers. I knew they would seek a more fitting time and place.

Towards evening I received a brief note begging me to call at the residence of Mrs. Reed, and expressing sorrow that in the overwhelming excitement of feeling attending the rescue of "Little Harry," his preserver should have been allowed to depart without even the poor recompense of thanks. It was not without considerable trepidation that I started to obey this summons. I wished—as who would not under similar circumstances—to make a favorable impression, and yet, I much doubted my ability to do so. It was true I had plenty of faith in my conversational powers, and was conscious of possessing a sufficient fund of general information to draw upon; but the society in which I had mingled for the two years preceding was far from refined, and I therefore dreaded that enough of its baleful contagion still elung to me to infect both speech and manner. It was a humiliating thought—one that made me very wretched; and yet, reason told me that it was a hopeful sign of inward regeneration—a sign of repentance and amendment. As I neared the house, pride, or something akin to it, came to the rescue, and I gained courage to appear, at least, calm and collected.

I had not time to ring the bell when the door was thrown open by little Harry, for that was his name, and he rushed out to meet me. His large, dark eyes surveyed me for an instant, then, taking me by the hand, he said with childish glee—

"Oh! I'm so glad you've come! Ma's in the parlor, and wants to see you so much."

"I suppose you were pretty well frightened to-day," said I, as he led me through the hall.

"Wasn't I, 'though!" he exclaimed, shaking his head, "and ma' was scared awful—wasn't you?"

Before I had time to reply, we were in the presence of his mother, who arose to receive me. There were tears in her eyes, and her voice betrayed much emotion, as she said—

"I took the liberty of sending for you, sir, that I might have an opportunity of thanking you for the life of this dear boy. I know that anything I can say will fall far short of what my heart feels; but a nature like yours will easily understand me. I thank you, sir, from my inmost heart; and may God reward you!"

I was deeply affected, and replied with much embarrassment; but when Alice entered and added her acknowledgments to those of her mother, the warm blood rushed in torrents to my cheeks, and I stood abashed and confused. In spite of this momentary confusion that piqued my pride somewhat, the fact that I merited the thanks and approbation of that sweet being increased my self-respect wonderfully. I felt that I could once more claim to be a man—that I could meet the eye of the world without a blush of shame, and take rank in society with the best of my fellows.

The entrance of the brother of Mrs. Reed, Mr. Williams, by whom I was warmly received, relieved me from all embarrassment, and I took an active part in the conversation that followed. Both ladies gave ample evidence of high mental culture and extensive acquaintance in the world of letters. There was a rich freshness about the elegantly-worded thoughts that fell from their lips, and a vein of charity pervaded their criticisms of "men and manners." Music was discussed in a manner that proved it a passion with them; and a ballad, at that time very popular, was highly praised by Alice, as possessing rare elements of beauty, both in poetry and music. Having frequently heard it at concerts, I agreed with her as to its merits, and begged that she would sing it. The memory of that sweet, gushing voice once heard in the village sanctuary, gave promise of a rich treat, and I was not disappointed. I have heard the same simple, touching ditty sung by those who stood first on the list of fame as vocalists, but never with such thrilling effect—her heart and soul were in the song and tuned her melting voice to every word; nor could Thalberg himself have excelled the artistic excellence of the accompaniment. "If fate," I said, enthusiastically, "had only spared the author of that song to hear you sing it, he would have been content to rest his fame on that one production and die."

"Ah! Mr. Long, I see that you are given to the sin of flattery," she answered, smiling, "but it will not avail you with me. Just think of it! You, a Gothamite, fresh from the opera and concert-room, to praise my poor performance so extravagantly—it will never do Sir, never!"

"You wrong me," I replied; "I am perfectly sincere in what I say. I never listened to music like that in opera-house or concert-room. If I over-estimate your singing, you must blame my judgment rather than my sincerity. The truth is, our public singers, with but few exceptions, strain after startling effect rather than truthful beauty; they prefer noisy rounds of applause to that quiet, heart-felt, but undemonstrative appreciation that true musical taste never transcends. Just imagine a theme as sad as the last dying wail of some poor, broken heart—a theme that, sung in the spirit of the poetry, would melt the heart of a Nero; and then imagine it greeted with a storm of



clappings, stampings and shoutings; does such an inconsistent demonstration speak well for the truthfulness of the performance? I think not."

"I admit the truth of what you say with regard to professional vocalists," answered Alice, "but I must repudiate your opinion of *my* singing, until you descend within reasonable bounds in your laudations. Why, there is Uncle John," she added, playfully, "he often becomes positively annoyed at my screeching, as he pleased to call it."

"I admit the charge, Alice," said Mr. Williams, "but it is only when you endanger your lungs by venturing upon some of those outrageous opera pieces. Sing 'Sweet Home' for me, and I can listen all day, aye, for a week; but deliver me from 'Norma' and all such stuff!"

"I see you are all against me," exclaimed the fair girl with mock petulance; "but I'll punish you," so saying she struck into a brilliant prelude on the fine-toned piano, and, aping all the airs of a prima donna, sang "Hear me Norma" in dashing style.

Even now, I look back on that memorable evening, spent in social converse with my new friends, as one of the happiest of my life—one that will always live fresh in my memory.

"I trust, sir," said Mrs. Reed, when at a late hour I arose to depart, "that you will visit us often. You are a stranger in our town, and boarding-houses afford few of the comforts of home, so you must spend some of your evenings with us. You will always meet a hearty welcome, for we can never forget you, never!"

"Yes, my young friend," added her brother, "consider this roof your own, and me your friend. Don't stand upon ceremony with us, but come often. Alice, here, will only be too happy to have some one to sing for, won't you, my dear?"

"Any one but you;" cried Alice, laughingly boxing his ears. "Whenever you want music, Mr. Long, come here and you shall have it; but no more criticisms, Sir, remember that."

"I am deeply grateful for your kindness," I answered, "my visits will be neither few nor short, I promise you; music and friendly faces are temptations I cannot resist. Good night!"

I pressed the hand of each, and took my way homeward, full of new feelings and aspirations—new determinations to inaugurate, new reforms both of heart and head.

A year passed on—a year of such tranquil happiness as I had never known. Much of my leisure time was spent in the family circle of Mrs. Reed, and all that pure, ardent friendship could do towards making me feel as one of themselves, was done. Little Harry and I were playmates, and many a wild romp we had together. There was only one drawback to my complete happiness, and that, alas! sometimes threatened to destroy me. I loved Alice Reed with all the strength of a first and only love, and, with bitter despondency, I saw that there was nothing in her bearing towards me to warrant even a hope that it was returned. This was my only sorrow, sometimes, it is true, a word or a look would set hope to building castles in the air; but another word or look was sure to follow that dashed them to pieces; indeed, I often fancied that her manner towards me was studiously guarded. Had she discovered the state of my feelings, and did she thus

seek by unvarying coldness to teach me that I had nothing to hope? It seemed but too probable, and the thought made me very wretched. I have learned since, that men in love take very circumscribed views of matters in general, and it is not wonderful that I formed many crude ideas about the peculiar relation in which I stood towards Alice Reed. But my eyes were soon opened.

One beautiful moonlight night, I sought the dwelling of Mrs. Reed, I was in a frame of mind far from enviable. All day an inexpressible sadness had weighed down my heart, and my thoughts were of the most gloomy description. I had absented myself for more than a week, in the vain hope of conquering the hopeless passion that ruled me, and I was much embarrassed how to explain to my friends the singularity of my conduct; it was the first time a week had passed without seeing them. As I traversed the garden the voice of Alice humming a plaintive air reached my ear, and told that 'though no lights shone from the parlor windows, it was tenanted.

"Ralph," said she, as I entered, "I am glad you have come. Something told me you would be here to-night, and so I stayed at home to receive you. Mother and Harry are spending the evening with a neighbor; but where have you been so long? You have not been unwell, Ralph, have you?"

"Yes, Alice, but only in mind."

What prompted me to make such a reply I know not, perfect recklessness, I suppose; for I ought to have known that my language would call for an explanation. She looked at me in surprise for an instant, and said, reproachfully:—

"Was it right, Ralph, was it kind, to thus deny us the opportunity of even sympathizing with you? This was certainly not like you."

"Did you but know all, you would scarcely blame me," I answered bitterly.

"I can imagine no cause," she said, warmly, "that would justify neglect of us—no cause save *indifference*, and that, I know you do not feel."

"Yes, Alice, there is another cause. What if I should tell you that a sense of danger to myself restrained my visits?"

I looked into her face, and, by the straggling moonlight that stole through the windows, I saw that it was flushed with crimson. She understands me then, I thought. But there was a covert smile lurking about the corners of her mouth that puzzled me.

"And what may this terrible danger be, Ralph?" she asked in a tone I thought careless, almost heartless. It stung me to the quick.

"I will tell you Alice, since you ask the question, I—I love you, and—"

I could go no further; my heart was full to bursting, and I buried my face in my hands. There was a silence of a few minutes, and I felt her hand laid on my shoulder as she said, softly:—

"This is not new to me, Ralph, I have seen, and known it for months."

"And you!" I cried springing to my feet.

"Love you in return, Ralph—love you dearly!"

This startling transition from utter wretchedness to the realization of my wildest dreams of bliss was too much to bear calmly. I drew the dear girl to my heart, and, bowing my head on her shoulder, wept like a child.

Reader; I was about to say more, but Mrs. Long has

just deposited Ralph, Jr., a bouncing little chap of two summers, in my lap; and as the young gentleman has a decided penchant for upsetting ink-bottles and tearing paper, I must close here, trusting to your own imagination to finish my story.

## The Home Circle.

For the New York Coach-Maker's Magazine.

### BROKEN VOWS.

"A LETTER for me! O, thank you Ed!" but the hand so eagerly lifted just failed to grasp the prize.

"Not until you promise to sing me a song, or tell me a story."

"Why, Ed., you *know* I can't sing; and as for telling a story, I've no gift for that, either."

"You know the alternative."

"If I promise to sing you a song, *that* will be telling you a story (since I can't sing a single tune), and will entitle me to my letter."

"No; the story must be founded on fact."

"Well, give me the letter; I promise you a story."

"Founded on fact?"

"Yes; founded on fact."

"A short letter is soon read; and now for the story. But, Kate, what do you think? Anna Austin has married a widower, after all, and is now Mrs. Fred. Benton."

"O! Bessie, tell Ed. about those vows, and how they've all been broken."

"Four years ago, this winter, a party of us were visiting Anna and Emily Austin. We hadn't any of us met for two or three weeks; consequently there were many items of general intelligence to be discussed. 'Girls,' said Carrie Davis, 'have you heard that Jennie Ball is married?' No, we hadn't any of us heard it, and Carrie proceeded to give us all the particulars. 'Married a widower, did you say?' 'What, that pretty, young girl marry an old widower!' 'I did not say *old*; indeed he is quite a young man,—scarcely past thirty.' 'Well,' said Anna Austin, 'I vow I wouldn't marry any widower, old or young. I couldn't be contented with a second love.' Carrie 'wouldn't mind his being a widower;' he was a minister, and for her part, she thought Jennie had done very well, 'better than Fannie Cobb, who is the wife of her cousin, or Miss Stork, whose husband is *six months* her junior.' And Carrie vowed that *her* husband should be as many years older than she. Emily Austin was sure that a minister was the last man in the world—unless it was a *cousin* or a *pedagogue*—whom she would marry. A dozen hands went up, like so many exclamation points, for we all magnified the office of a minister; but Em. had evidently given the subject more thought than we. How she came to reconsider it I never learned; I only know that she is a matron now, and that her letters are directed to the care of *Rev. J. M. Austin*, who is *her father's nephew*. Martha Higgins said that since the others were taking vows upon themselves, hers should be not to marry at all. Of course, some of us raised an outcry against her, but all joined in giving her sister, Sarah, a word of caution, when she announced it as her solemn determination to accept gratefully the first offer of marriage she should receive thereafter. Before the winter was over, I saw

Martha stand up beside a gentleman, and promise to love, honor, and obey him, and a minister present pronounced them husband and wife. Carrie Davis was there, and hoped the vow of obedience would be kept more sacredly than the one Martha had just broken. She was reminded that a bad promise is not binding. Carrie didn't know about that; she was sure of one thing,—*she* never made promises that she couldn't keep. Didn't I remind Carrie of that, two years afterward, when she told me she was going West with Tom Wilson! But Carrie only laughed, and said she hadn't met Tom then, or she never would have made that vow. And Tom *was* one of the best and manliest boys in the world; *but then*,—Carrie is twenty-seven, and he is five, not months, but years, younger! O, Carrie! it will be four years next spring, since Mrs. Benton died. She was one of Anna's most intimate friends; but Anna's own letter shall tell the story:

"DEAR BESSIE:—Let me bespeak for Anna Benton the same love you gave so freely to Anna Austin. I did want to tell you, long ago, of my happiness, but I remembered a foolish vow I once made, and knew that you had not forgotten it. I could not bear to have a 'railing accusation' brought against me then; now, my happiness is complete, and I do not dread your raillery. I have married a widower, and am contented to be his second love. You know that Julia Benton and I were intimate friends—more intimate than sister Emily and I ever were. I spent much of my time with her in her home, and saw her every-day life, and that of Fred. I marked their delicate attentions to each other,—their perfect *oneness* of feeling, and contrasting them with every other married couple I had ever known, they were the only ones who realized my dreams of domestic happiness. I was there during the long illness which preceded Julia's death, and saw how with even more than a mother's tenderness, Fred watched over her. But, Bessie, I would not measure any one's love by his care for the *dying* (the hardest heart must melt into something like tenderness then), but by the care which is ever watchful to lead the *living* in the gentlest paths. Three years after Julia died (nearly one year ago), Fred asked me to take her place in his *home*. He did not say in his *heart*, and I loved him for it. I would not accept a place in a heart that could replace one love with another, as we exchange an old glove for a new one. It is true I hesitated at first,—charge that to my pride, that was not willing to take a second place,—but while doubting, I found that his esteem was more to me than the love of any other living being, so I took *Julia's* place in his home, and have made a place for myself in his heart. Come, Bessie, and see how happy I am. Do you remember Sallie Higgins' vow to accept gratefully the first hand that should be extended to snatch her from a life of single wretchedness? I know of more than one worthy man who has offered her his hand, but she seems not to regard any one with deeper feelings than those of friendship. Let me say again, come soon to your loving friend,

ANNA.

"Anna forgets that 'the pen is the tongue of the absent.' Sarah spoke truly, but she knew we would all think her jesting. None of us knew at that time that she was regularly exchanging letters with Frank Lee; but it was so, and the interest which each had at first taken in a mere friendly correspondence, was assuming a deeper tone than the term friendship can express. She alone kept her vow. Frank is coming home in the spring,

and they will then seal with marriage the engagement made four years ago."

"Pshaw! Bessie, when you named your subject I thought you were going to tell me a *real, orthodox love story*. But you have not told us about *your* vow, and its fulfillment."

"No! I didn't want to make a promise I couldn't keep; so, with characteristic prudence, I declined recording any, not knowing but I *might* be tempted above that I was able to bear."\*

For the New York Coach-maker's Magazine.

### WOMAN'S PERVERSITY.

BY LUA DELINN.

"THE winds are striving together with the strife of those who hate,  
And clouds o'er the skies hang darkly, like frowns on the face of Fate.  
Whence shineth the light around us? whence the glow that makes so warm,  
That we heed not the heavy darkness,—the chill of the wintry storm?"

(Full well I knew the meaning of the word, the look, the tone;  
It thrilled my heart with a pleasure that I did not care to own).  
"And why should we heed the darkness, the cold of this winter night?  
The grate is heaped and glowing, and the Astral burneth bright."

"Does the lamp that is burning brightly one ray to your mind impart?  
The fire on the hearth that is glowing, hath it power to warm your heart?  
O! life is cold and stormy, and dark as this winter night,  
When the winds are madly striving, and clouds hide the stars from sight.  
There are lights that gleam and vanish, as fire-flies come and go;  
Lights that but feebly glimmer, and give to the heart no glow.  
'Tis the flame of love that only a steady light can shed;  
O! love, look up and tell me, shall it gild the path we tread?  
Thy hand in mine, and pledge me that I need not walk alone,—  
That henceforth and forever thy path and mine are one."  
(The clock that stood on the mantel repeated solemnly, *One!*)

"No! no! life is *not* stormy, but peaceful mine hath been,  
All these many years unclouded (you know I'm just seventeen).  
I am sorry that storm and darkness are all that your life hath known;  
*My pathway is one of sunshine, and—I like to walk alone!*"

I heard the sound of his footfall,—his footfall heavy and slow;  
And there fell on my heart that moment the weight of a heavy wo;  
An icy chill came o'er me (in spite of the "glowing grate"),  
More dark than those clouds so stormy hung frowns on the face of Fate.

When the harvest fields were bending 'neath summer's golden grain,  
The gentle tones of my lover spoke peace to my heart again.  
And yet when again he offered his heart so true and tried,  
Do you think that again in my folly I flung the jewel aside?  
Ah! when did *woman ever* turn an idle ear to *Pride!*

"Can the lover of one so fickle as to change when seasons change,  
Be worth to you the asking? Methinks 'tis passing strange,  
I am not one, believe me, who can thus lightly change."

I heard the sound of his footfall as he turned away from the door,  
And that heavy weight of sorrow rolled back on my heart once more.

CONTEMPT will sooner kill an injury than revenge.

## Pen Illustrations of the Draft.

LIGHT ROCKAWAY.

Illustrated on Plate XXXIII.

THIS kind of carriage, as most of our readers perhaps know, derive its generic name from that of a celebrated watering place in the vicinity of New York city. No carriages of one class are more varied in form than these. The one we now give possesses no feature of novelty in its design, but has its usefulness in that it may be shown to a customer as one example by which he may the more intelligently give the manufacturer an idea of what he wishes built. The body can be built either "paneled" or "solid," as lightness or price dictates. In the April number we intend to present something from Mr. Irving, of the Rockaway kind, entirely new.

For the New York Coach-maker's Magazine.

PHYSICIAN'S ROCKAWAY.

Illustrated on Plate XXXIV.

WILMINGTON, DEL., January 10th, 1860.

EDITOR OF COACH-MAKER'S MAGAZINE: *Dear Sir*—According to promise, I send you a drawing of a Doctor's Rockaway, which you will, of course, use, or not, as you may think best. I believe that this kind of carriage is original with Mr. Wm. D. Rogers, of Philadelphia.

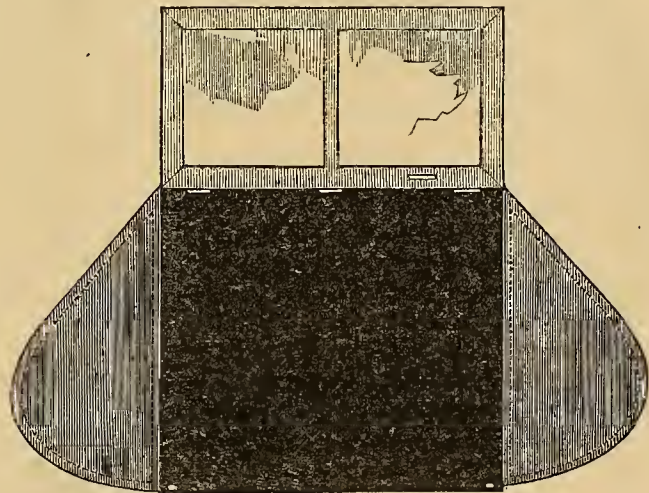

I think the accompanying drawing is of more interest to Doctors than the draft, as it answers every purpose for which it is intended. Dr. H. F. Askew, of this place, with whom the boot is original, has had one in use some months. This apron (or call it what you will) is fastened with two hooks. It furnishes a perfect protection against stormy weather, and is easily detached from the vehicle in fair weather, and may be left in the carriage-house. The side-flaps fold in, and the sash being down, the whole may be thrown forward against the front pillars, and there fastened by spring-catches, which clears the way for getting in and out. With this apron, this carriage could be made without a front pillar, and the half-door as in the drawing.

Yours respectfully,

E. HUNSBERGER, of E. H. & Co.

## PANELED-BOOT OPEN-FRONT BUGGY.

*Illustrated on Plate XXXV.*

OUR number for February contained about the latest "cut" of the New-York style of Buggies. With this we give another very popular form, very much admired by "the fancy." In it are combined the Byron and the one spoken of above, making a very light and pretty "turn-out," when the paneled boot is properly painted and ornamented. The prevailing mode of finish here is to leave off the striping altogether. Without the top, this buggy will answer the purposes of a light road-wagon. Stitching in white has about "played out" in this direction, and falls, &c., are generally stitched with black. The tops of cushions should be of cloth, tufted.

## Sparks from the Anvil.

For the New York Coach-maker's Magazine.

## C-SPRING.

THE principle of this spring is shown in the following cut. The bolt-scroll A on the end of the spring is about one and a half inches behind the square line B.

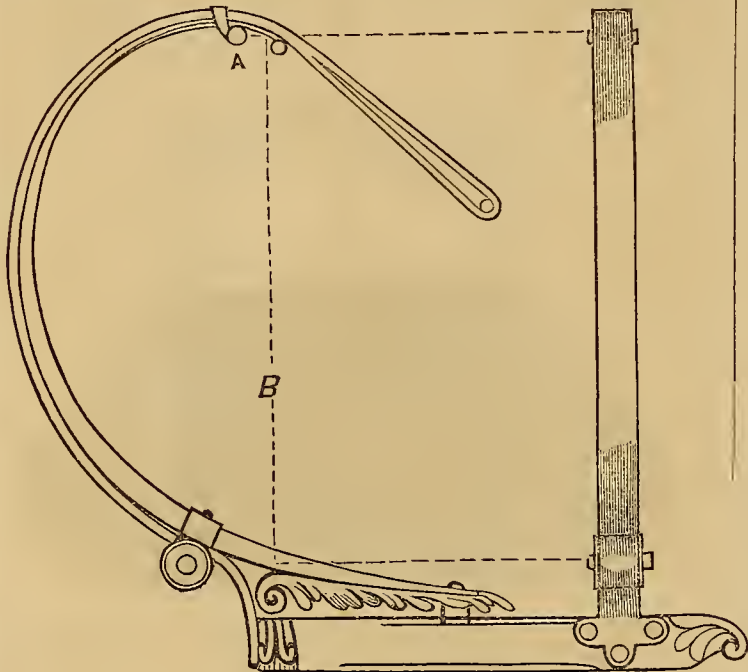

The manner of securing this spring to the carriage is fully shown in the diagram. The grand feature in this spring is the beauty of outline after the other points are observed.

## THE MOCK, OR UNDER SPRING.

THE top half of this spring is useless as a spring, it being merely required for a support for the stays, braces, &c. It is generally made of swaged iron from half-inch to three-quarter-inch, according to the strength required, and covered on top with a piece of one-inch ash, or

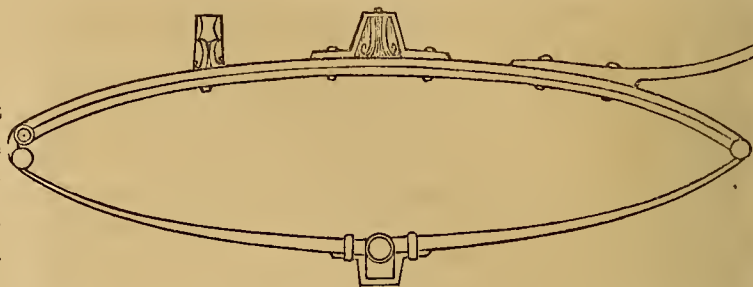

hickory. The axle on a job of this kind is generally cranked the thickness of itself, at the collar. J. I.

For the New York Coach-maker's Magazine.

## NEW METHOD OF FORMING SQUARE CORNERS.

BLOOMSBURG, PA., Jan. 26, 1860.

MR. EDITOR: *Dear Sir*—I send you the sketch of a new method of forming square corners in working iron of any size, from half-inch bars and upwards. Take a bar, round or square, and heat it in the fire until it is sufficiently hot, and afterwards cut it one-third through, so as to be the more easily bent to the shape illustrated in the cut, into which fit and weld a suitable piece of iron in the corner. This will make a good job, and avoid the liability to "gall" in turning, as in the old way.

Yours respectfully,

A. A. CROSLY.

## Paint Room.

For the New York Coach-maker's Magazine.

## GOSSIP FOR THE PAINT SHOP.

*(Continued from Page 172.)*

It would be a waste of time, and also encroach upon the patience of the general reader, should I occupy the columns of this Magazine with anything that would not interest a portion of its patrons; therefore, having said a few words upon the principal colors used, we shall not divide them into the many different shades which they are subject to, or yet discuss those colors that are seldom used. In the good old times when stage-coaches were all the go in England, the painter had to have a little more knowledge of fancy colors than what seems requisite nowadays. All stage-coaches were then invariably painted blue, red, yellow, white, and black; each and all of these requiring all his skill to finish to satisfaction; and especially ought a majority of the painters of the present day be congratulated upon the fact of yellow being considered an unsightly color in this country, for it always was a test, and still is, of his ability in all the different branches that painting can be divided into, viz., ground-work, coloring, striping, and varnishing.

There is nothing in my mind equals an English nobleman's chariot, or it may be a foreign ambassador's court-carriage, painted patent yellow. The beautiful delicate

tint of the color, in contrast with the best of jet black the art of the manufacturer can produce (the panels being polished and smooth as a mirror), and the striping so regular, and every part in unison with each other, together with the large and noble-looking family and national coat-of-arms—all combined, make it one of the handsomest pieces of work the carriage-painter can possibly execute; and no one that has not seen such a vehicle can comprehend or appreciate its merits.

The English patent yellow is prepared differently from any other color used in carriage-painting; but as the reader is not likely to be troubled with having a job to be painted that color, we shall not take up space in explaining it. It has been supposed from the first that we had a body painting; so we have, but it is so long since we thought of it, we have to hunt it up; we find it, and it appears we have done considerable unto it. Let us recapitulate. We have given it two coats of oil-lead, then puttied it up and given one coat more of oil-lead; we have then given five or six coats of rough stuff, having the last coat in great contrast (as regards color) to the others, to serve as a guard for the rubber, for when this last coat is rubbed off, there must be a surface; we have sand-papered and dusted it off cleanly; then given it a coat of the right kind of lead, and looked the surface particularly over with hard stopper; have let it dry hard, and "faced" it with block pumice-stone; sand-papered it once more with the finest paper, and dusted, and after which have given one more coat of the same kind of lead; examined once more the surface, and repaired all damages with hard stopper, which we rub with hard pumice-stone, and the remainder of the body sand-papered well. The inside being very dirty, we will give it a heavy coat of lamp-black, mixed with varnish-bottoms, and a little oil in it, to make it work free; and the body being as good as paint and putty can make it, is now ready for the colors. As it is optional with us what color we paint it, we will choose lake, because it is so simple, and yet gives the inexperienced the most trouble to finish with satisfactory results. We will suppose we wish for a rich dark purple lake, and our body is in a moderately light lead color; and as we wish to turn out a good job (being unrestricted as to time), we will do it as good as it is possible for it to be done, at the same time remarking how it might be done, if wished to be "put through."

Best black will not cover well upon lead color, and of course would not make a solid ground-work; so, to insure that, we will first give it a coat of lamp-black, prepared as before directed, making sure of having sufficient sugar of lead in it to have it dry hard, say in forty hours, but be careful and don't get deceived in thinking it dry, when it is no more than half-dry, for if it works up in our next coat, there is no other remedy than to wash it all off. Being dry, we take a little curled hair, and give it a good rub all over (best black might be substituted for lamp-black if the job was in a hurry, and the imperfections of it not being sufficiently solid, would not be detected unless placed in an unfavorable position, such as being placed in the sun, when it most likely would look a little "streaky"), and well dusted; we will give it a nice coat of best black all over, having the color very finely ground, and being very particular not to lay it on too thick, having enough oil in it to prevent it from drying too quick, and not enough to keep it from drying say in forty-eight hours, after which it is ready for lake; of which we have spoken,

and will only add, that nothing darker than good raw linseed oil ought to be used in preparing it, for it takes but little to destroy its richness and brilliancy. All it has to come in contact with should be perfectly clean: the stone you pulverize it upon, the mill you grind it in, and the pot you put it into, should all be as clean as possible; for either one of them being dirty will detract a little from its perfectness. Lake can be ground to satisfaction in one of our common paint-mills; but the mill has yet to be invented that will bear comparison with a good hard marble slab. With all due respect to Mr. James Scott's opinion expressed in the August number (volume i. page 52), I must say that a good fine bristle brush, well worn, would be my choice to lay lake with. You have not then to thin your color until there is no body in it, which you have to do to make it applicable for a blender.

We have before stated, if your lake be good, two coats will make a solid color; and if it be bad, you can never make it good, give it as many as you will. Having given that part of the body which requires lake, one coat, your black should now receive your attention; and most likely the reader is familiar with the remark that it is "more difficult to paint a good black, than any other color." This is true to a certain extent. If a man has not the materials he cannot do it. A painter that has but an indifferent black, and nothing but a dark colored varnish to lay over it, and a still darker Japan to mix it with, cannot be expected to turn out the best jet black, and to compare English black Japan alongside of it makes it look miserable indeed. Painters who reside in our large cities, and but seldom go into one of the thousands of small shops which are scattered throughout the country (in small cities and towns), where, for the most part, light work is built, must bear patiently with me if I trespass with a few remarks upon English black Japan. I know many of them know all about it; but they must consider that ninety-five per cent. of these small shops have never used, seen, or heard of it, and it is for their information we mention it.

This black varnish is the best of black used in painting; the English best drop-black bearing but a poor comparison alongside of it. It is applied and works similar to the best English varnish, and costs about the same money—five dollars per gallon. In some cases, where it is known and appreciated, the cost prevents it from being more extensively used. Manufacturers pay three dollars per gallon for varnish, and they think of course it must be the cheapest; but I take that to be a mistaken notion, for I think the quality more than makes up for the price. Black Japan is a thin, light substance, the same as English varnish, and is susceptible of being laid on very thin; and men experienced in laying varnish know that one gallon of English varnish will go over more than two-fifths more surface than one gallon of our heavy American varnish. So that it more than makes up for the cost. Every coat of black Japan given, requires one coat less of varnish; consequently the difference in cost is but two dollars per gallon, and taking into consideration the quantity of surface it will go over, and the beautiful jet black it gives, makes altogether to the interest of carriage-builders to use it. All colors show up much better by being in contrast with good black, and all solid blacks have but a poor show alongside of black Japan. One coat upon best black, covers and makes an excellent black, but by laying two it is still better. I think it a good plan to lay one

coat of varnish over black, then rub down and give one coat of black Japan; or it may be used all through, except the last coat, as it has no durability in itself when exposed to the weather, and requires varnishing. It rubs good, and as good a surface can be got upon it as on any other varnish. It should be kept as air-tight as possible; for when too much exposed, it is apt to thicken, and will not then work so pleasant.

A great deal of English work never gets any drop-black, as two coats of black japan upon lamp-black, makes a solid color; and after giving the third (having a good surface), you can rub down for the last coat. It is perhaps needless to say that, in ninety-nine per cent. of English carriage-painting, black japan is used for the work requiring to be painted black. Even the black striping upon blues, lakes, yellows, vermilion, light greens, and all colors which show up black, or black shows the color up, is first striped with drop-black, and afterwards gone over with black japan. If the excellence of this article were more widely known, I am sure it would be more extensively used; and as I always use and advocate its use, we will suppose we are using it to the body we are painting. Accordingly, we will give the black part a nice even coat of black japan; and the lake being perfectly dry, we will give it the second coat of lake. A thin coat of black japan will dry sufficiently well to rub in forty-eight hours, though it may feel a little "tacky." Fine dust, and a gentle rub, not laying on too hard, will prepare it for the second coat; but it requires rubbing, and the surface sufficiently breaking, or it will neither take a second coat of varnish nor japan, as it dries with an oily, glassy surface; and either, laid on without first going over it with water or curled hair, will erawl up into lumps, and the painter is sure to have trouble with it. If the lake is good, has been ground fine, and applied as it ought to be, it is ready for a thin coat of varnish. Even if it is only passably good, we would prefer clear varnish to mixing color in it. When we say a thin coat, we would not imply varnish half turpentine, but good pale varnish the consistency of the best English varnish, well spread on; and it should be equally as pale for lakes.

The japan being dry, and our job being a large, full-quartered coach, we will now give the quarters, boot, and all that are within sight, a second coat. The roof, bottom, insides of doors, are optional, but would be better done. The varnish upon the lake being ready for rubbing, we proceed to rub it as much as it will bear, taking care not to go down to the color. This being finished, it depends upon circumstances what shall be done next. If the lake was of an inferior quality, and the varnish we have upon it not of the palest and best quality, we ought to lay on another coat of lake. But this is a critical stage of the job. If you have a good hard varnish upon it that not only feels dry at the surface, but is hard at the bottom, another coat of oil-lake cannot do any harm; but, if your varnish is a sweaty, slow-hardening varnish, and you put anything upon the top of it which will dry and harden quicker than itself, you ruin your body; for sooner or later it will be sure to crack. The lake for this coat should have more oil in it, have plenty of time to dry in, and should dry shining. After it is thoroughly hard, another even coat of good pale varnish may be given, which makes two coats of varnish for the lake, and two coats of black japan for the black work.

It will now bear a tolerably good rub; and were it a

smaller vehicle (having had a good surface to start with), it might finish with one more coat of varnish; but being a coach with large plain quarters, we will give it an excellent rubbing, and one more, what we may term a "flowing coat of varnish," which does not imply it should be laid on as heavy as it might be, but enough for the brush-marks to flow out of it. Beforetime, we have only varnished up to the molding, but now we go all over; and if our stock has been up to the average, and the painter does not make a good job, I should be apt to lay the fault with him in not having the ability to do so. All the varnish being now on previous to the last rubbing, and as it will take considerable time to harden, we will now send it to the trimming-room to be trimmed, while we chat upon varnish, and what has been written upon varnish in the columns of this Magazine.

(To be continued.)

## ORIGINAL ORNAMENTAL DESIGNS.

*Illustrated on Plate XXXVI.*

THESE very spirited designs have been in our drawer a long time and had almost been forgotten. They were furnished by our friend Mr. J. C. Norris of Canada, and are very creditable to his pencil.

No. 1. The ground work of the dragon's head and the minor details about the figure, is left entirely to the taste and fancy of the painter.

No. 2. In this figure, the ground work of the copias may be white, black, and Naples yellow, shaded with French blue, and drop-black, mixed; the dark shades glazed over with burnt sienna. The hair of the manes can be done with burnt umber, lightened with Naples yellow; the fleshy parts being done with flesh-colored tints according to fancy. The drapery will show well in purple.

## Trimming Room.

### STITCHED CLOTH LACE.

A FRIEND in this city, who is quite an ingenious carriage-trimmer, has been experimenting with cloth as a substitute for lace for the inside finish of carriage-tops when the curtains roll up. He assures us that he finds that when dark cloth—used as leather has sometimes been—is stitched with white thread in figures, it looks very neat and tasty, especially in a buggy. We recommend to our readers a trial, and afterwards to give us their opinion of its merits.

### NEW STYLE OF TRIMMING FOR A 'PRINCE ALBERT.'

THE illustration here given represents the cushions and the back and side linings of a Prince Albert. It will be seen that the style is neither straight nor diamond, but is drawn in the center, and fastened with silver ornaments. This mode of trimming is called "the Oriental style," as

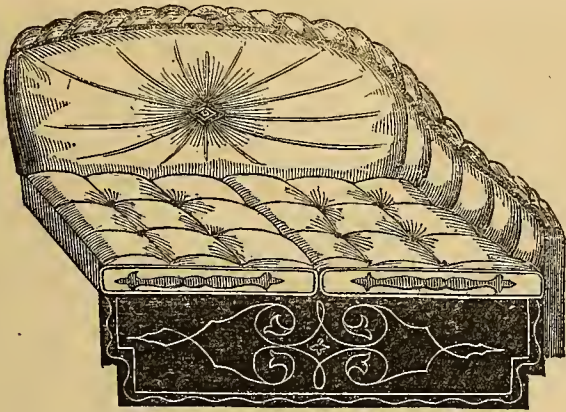

it is an imitation of that prevailing in Turkish vehicles. The roll on the top is made in what is called the herring-bone fashion. The fall is designed to be cut out of harness-leather, and stitched as seen in the figure. The whole represents a very pretty style of finish where a little fancy is to be exercised in the taste.

#### COCHINEAL CULTIVATION IN TENERIFFE.

THE brilliant carmine of the leather-dresser, and the rich scarlet and crimson colors of the silk and woolen dyer, are produced from a small bug which feeds on the cactus plant. This insect, called "cochineal," was unknown in Europe before the discovery of this continent. It was first exported by the Spaniards from Mexico, where it was employed by the natives in producing those beautiful red colors on feathers, which were made into divers curious Indian fabrics. Cochineal is sold at from one dollar and a half to two dollars per pound. At one period, its cultivation was most limited to Mexico proper; but it has lately been extended to other countries, with very profitable returns to those who have engaged in it. Its introduction and present extensive cultivation in the island of Teneriffe, forms a remarkable episode in the history of the plants and people of that wonderful island, whose volcanic peak is seen from afar on the ocean, towering up, like a huge sugar-loaf, twelve thousand feet into the blue vault above. For three hundred years this island had been a vine-producing country, and wine was the principal article of its commerce—as much as 25,000 pipes being exported annually; and who would have thought that it ever would be otherwise? But sometimes revolutions take place in the natural, as well as the social world, and about fifteen years ago, "the handwriting of doom" went forth against the wines of Teneriffe. The "vine disease" fell upon the vineyards, the fruit withered, the plants died, and starvation stared the people in the face. The American vessels which used to frequent the island to exchange flour and provisions for wine, deserted the harbors. What were the people to do?

Some years previous (in 1835), a native gentleman, knowing that the cochineal was cultivated profitably in Honduras, thought it might be equally so in Teneriffe. He therefore introduced the cactus plant and its attendant insect, and set out a cochineal plantation. The people around him, blinded by a strange fanaticism, thought that the cultivation of the cactus was something insulting to the vine; and they destroyed his plantation at night. But, being a man of some determination, and supported, happily,

in his views by government, he was so encouraged as to adhere in his efforts to cultivate it as secretly as possible, in some lonely spots; and he was at last rewarded for all his trials and labors. When the grapes died, and despair seemed to settle down upon the people, as the vine was their principal dependence, the question was sent forth, "Why not try to convert the abandoned and withered vineyards into cochineal plantations?" A *furor* seemed to seize the people in its favor, as it had already been demonstrated that the cochineal insect propagated rapidly, and the cactus flourished luxuriantly. The deserted vineyards were converted into fields of the cactus plant, and such a profitable investment was never made before in the culture of the soil, even in the palmiest days of wine-growing. An acre of ground set out with the cactus plant, yields about 300 pounds of cochineal, and under the most favorable circumstances, 500 pounds, for which the owner receives about \$340. The peasant women nurture patches of the cactus around their cottages, and thereby acquire considerable convenient little sums for domestic purposes, as the cochineal is always marketable, and in demand.

The cochineal insect resembles a plump rose-bug when dried. The female parents produce young in very great numbers; the males resemble gnats, are very short-lived, and are few in number in comparison with the females. The latter, when young, are white, but gradually become purple in color, by secreting the fluid derived from the plant—that for which it is so valuable. When filled with this secretion, these insects are shaken off the plants, placed on clean boards, and dried in ovens, which process prepares them for market.

It ought to humble personal human pride when it is considered that its gratification is oftentimes due to very despised sources. Thus, the cochineal insect, or bug of the cactus plant, is employed to put the artificial rose on the pale cheek, and the bloom on the new scarlet uniform in which the young soldier takes so much pride. At some future day, cochineal may become an object of culture in Florida and Texas, where the cactus and its purple insect abound.

#### LITERARY NOTICE.

A NEW humorous and satirical journal with the significant title of *Vanity Fair*, something in the style of the London Punch, has recently been started in this city. The aim of this publication is declared to be "to interest and amuse the public, while conveying sharp sermons and pungent lessons on all sorts of topics, to all sorts of people." Unquestionably, the humorous predominates in the American character, generally, as far exceeding any other nation in this respect, as this new candidate for public favor does any of its predecessors in this particular line. Published every Wednesday, at 113 Nassau street, New York, at \$3 per annum, or six cents a single copy.

Our great favorite, the *Atlantic Monthly*, for Feb. again graces our table. It is well got up as regards paper and press-work, in this respect showing that in its new proprietorship, the public have a guarantee of future excellence. The matter in this number is varied and interesting. In our estimation it is the gem of the monthlies.

## The New York Coach-Maker's Magazine.

MARCH 1, 1860.

E. M. STRATTON, Editor.

### TO READERS AND CORRESPONDENTS.

AGENCY—TO COACH-MAKERS.—*The publisher of this Magazine, offers his services to fill orders for any article his friends may want, to be found in the New-York Market, FREE OF CHARGE where the individual is a subscriber. None but orders inclosing the cash are invited. Letters of inquiry, &c., MUST contain two red stamps.*

 All letters directed to this office on business, NOT relating to the Magazine, but solely for the writer's benefit, must inclose a stamp; if requiring an answer, two red stamps. Orders for a specimen number must be accompanied with nine three-cent stamps. When these terms are NOT complied with, no attention will be given them.

 Name-plates furnished to order, of different patterns, for from \$14 to \$20 per hundred, at this office, or sent according to directions, by express, payable on delivery; to which express charges must be added.

G. H. W. OF CONN.—You will find the terms for clubs, &c. on the first page of the cover.

J. W. S. OF PA.—The coupling you refer to, should you buy a right, would not enhance the value of a carriage to which it might be applied, and besides might involve you in a lawsuit for infringement, as it is not yet certain who is the legal inventor. The safest way is to let "perch-couplings" alone for the present.

A. J. V. OF N. Y.—We give *all* the drafts of buggies, possible, consistent with the fashions.

### TO THE COACH-MAKING FRATERNITY.

Two more monthly parts will bring us to the end of the second volume of THE NEW YORK COACH-MAKER'S MAGAZINE, and to the close of our second year's labor as the conductor of this work. It is scarcely necessary for us here to say, that the publication has given evidence of progress; this will have been observed by our friends, in the better selection of drafts, in its mechanical execution, and in the greater and more varied number of valuable and interesting communications with which our talented correspondents have favored us. These evidences of our good intentions heretofore exercised, we trust will strengthen the confidence of the public in our enterprise, and enlist us many new assistants in adding to the list of our already numerous subscribers the coming year.

All that now appears to be necessary to the complete development of our original plan is, a wider field for the circulation of this work, which the low state of finances in the West has heretofore circumscribed. We have been wholly dependent for success up to this time, upon our Eastern fellow craftsmen (and they have done nobly); but we have many warm friends in Ohio and other adjoining States, who are only awaiting the ability to do so, to show us that their sympathy with our undertaking is pecuniarily substantial. Everybody says our Magazine is a good work of the kind, and all admit that it is in advance of its contemporaries in Europe, and well worth

the money charged for it. We have many assurances from all quarters that, now we appear to have become "fixed," they intend to get us up clubs for our third volume, that will prove to us that we have not been forgotten. We assure all such that we shall strive to deserve all that they may do for our benefit.

We have still on hand and can furnish complete sets of the Magazine from the commencement in June, 1858, to any who may desire it. Those, who are still waiting in expectation that we will reduce the price, may be assured that the work is actually worth more to-day than it was when first published, from the fact that the older the work gets the more interesting it becomes. This circumstance forbids our selling it for less than the original prices. We expect that in 1870 the work will have doubled in price (should any copies be for sale) caused by the change in the fashions alone, which for the purpose of contrast must make it very interesting.

### OUR PRINTING OFFICE IN ASHES.

READER! don't become alarmed; although burned out, *your* NEW YORK COACH-MAKER'S MAGAZINE is not yet burned up, and should even such a calamity happen, not oftener than once in a month, your monthly *dish* will always be ready in time. Our entire edition, including the February number, is safe, being stored in our office, 106 Elizabeth street, three-fourths of a mile from the fire that happened at 113 Fulton street, where our printing was done. We had placed one half of our copy for the March number, and a portion of the engravings, in the compositor's hands, all of which had been put in type, and the first eight pages "made up," and ready to go to press, when, at half-past one on Sunday morning, the 29th of February, from some as yet unexplained cause, "the lodging place of genius," or of whatever else fills up the columns of the New York daily, weekly, or monthly papers and magazines, was discovered to be on fire! So complete was the work of destruction, that every vestige of that portion of our property left in the building was destroyed, embracing all our advertising pages and tint blocks (mostly in electrotype plates), a large quantity of engravings for future numbers, the eight pages above mentioned, with the "copy," and twenty-three reams of paper placed there two days previously, *to feed the flames*. Our loss, on which there was no insurance, *only* amounted to \$300, a small matter in itself; but the amount of brain-work required in getting "copy" ready again, was where the trouble lay. Monday morning found us astir, and within nine days, our cuts, electrotypes, copy (some of it from over three thousand miles), were all replaced.

We are now in a new office, with new plates, new types, paper, &c.—which our subscribers will have proof of in the improved appearance of our Monthly—with *new*



determinations to study to please our fellow-craftsmen, in our future issues. The warm sympathy expressed for us, under our misfortunes, has had the effect of encouraging us to labor on. We have little doubt that our subscribers and ourself will both profit by the calamity; they get a better magazine, and the notoriety given to us, by the press, will make our Monthly more extensively known, and bring us extra subscribers enough to reimburse us for our losses. To this end we would direct the attention of our friends, and ask them to present the claims of our work to the consideration of their neighbors and workmen, that our circulation may be increased, from the formation of clubs and otherwise.

Among the sufferers with us are the *Ledger*, *Mercury*, *Spirit of the Times*, *Merry's Museum*, *Railroad Guide*, *Commercial Report*, and others, of less note; the whole losses of which, including the buildings, amounted to \$140,000. The insurance companies are many of them sufferers by this calamity; but the activity of the publishers burned out will very soon provide for the supply of food required in filling the intellectual stomachs of the million. In proof of this, our readers will see that we, as one of the parties, are out in our regular time.

#### THE NAUGATUCK CARRIAGE-MAKERS' RE-UNION.

SOME eighty-five miles distant from New York, on the line of the Naugatuck Railroad, has sprung up a village, within a very few years, which, if we mistake not, is destined to figure respectably in the future history of our country. Among the evidences of progress in this place may be mentioned the carriage-manufactory of the Messrs. Henry Stevens & Co., spread over nearly an acre of ground, embracing as it does, an office for business, the wood, smith's, and other necessary buildings for carrying on an extensive business.

A few rods north of the shop noticed above, may be seen a smaller one now occupied by a successor. In this small shop, some eight years ago, might be seen the two Brothers Stephens, with sleeves rolled up, exercising their naturally industrious powers, until their business had so increased that they were compelled to build the larger shops they now occupy. Notwithstanding that carriage-making in many other localities has had to succumb to the disastrous state of finance, during the most of that period this manufactory has gone on prospering, until now it employs some one hundred and twenty-five hands, male and female, in the different branches of the trade. Some idea of this success may be gathered from the following statistics. During the first year, and when the two brothers did a great part of their work with their own hands, they turned out ninety-five carriages; in the second year they sold one hundred and fifty; the third, one hundred and eighty-

four; the fourth, two hundred and fifty; the fifth, three hundred; the sixth, six hundred and forty; and the seventh, one thousand eight hundred and twenty. We alluded to this establishment on page 115 of this volume, in our visit to Naugatuck, and then noticed that the mutual good understanding between employers and employed had produced its usual good effects on all concerned. We found abundant evidence of this in soliciting subscribers to our work, where, from the first, we have found many warm friends to our enterprise.

In this manufactory the steam-engine and a systematic order in conducting the business, have had the desirable effect of economizing labor and expense in getting up work. In the trimming-shop, for example, a man is engaged, whose constant business is to cut out the leather for the linings and tops of carriages, after a pattern known to be correct. Every manufacturer knows that where men are allowed (as in the old method) to cut out each one his own stock as he needs it, there will be much wasted. This loss is avoided here by a judicious confiding of this business to one man alone, who perfectly understands it. As to female labor in trimming, some may object to this; but we are assured by those competent to decide, that in some parts of the linings, females do their work much better than men, because they are accustomed to the use of the needle from childhood, and are naturally more patient in carrying out the minor details of stitching, so as to be finer and stronger. Female labor, aided by the stitching machine, has greatly lessened the expense of trimming-work in this establishment.

Much of the work done here the past year has been of the kind that passes under the name of Concord wagons (named after a town of that name in Massachusetts), and, as got up by the Messrs. Stevens & Co., is highly ornamented, to suit the southern market. Those who are employed at this branch of the business are very expert; and, as we learned from the workmen, their wages are very remunerative. Our design, however, in writing this article was not so much to bring our friends into notice as business men, but to illustrate those nobler qualities of the heart, which, when judiciously exercised, result to the mutual advantage of employers and employed. We commend the "social" example of the Naugatuck firm to the attention of others, believing that one such is productive of more good than all the trade strikes that ever took place.

On Monday, the 16th of January last, the Messrs. Stevens & Co., by previous arrangements, had a supper provided for their invited employees at the Scoville House in the neighboring town of Waterbury. With a band of music, under the charge of a special conductor, "all hands" left the depot, a few rods from the workshops, for the place of the destined "reunion." On arrival at

Waterbury, a procession was formed, which with the music at its head marched into the hotel in fine style, with sharpened appetites for doing justice to the good things provided by "mine host" for the physical man.

The party numbered over two hundred ladies and gentlemen, sufficient to create a "sensation" in villages of larger pretensions than that of Waterbury. At the head of the table presided Henry Stevens, Esq., one of the principal members of the firm, who, after the company had done justice to the viands then spread out before them, delivered a neat and appropriate speech, in which he stated that for whatever success they had achieved, they were indebted to the active co-operation of their employees, who had shown an interest in the prosperity of the company, and had taken a pride in the workmanship and finish of the work as much as if it had been their own. Having explained to the company the object of the assemblage, the following toasts were presented:

THE PRESIDENT OF THE UNITED STATES—May he be successful in preserving the Union of the States, and soon find himself happily united.

Responded to by Mr. Campbell.

THE CONSTITUTION OF THE UNION—Our glorious carriage of State. May her *felloes* (fellows) ever be strong in the Union.

THE PRESS.

Responded to by Mr. Townsend, of the Waterbury American.

OUR INVITED GUESTS.

Responded to by S. W. Kellogg, Esq.

THE CARRIAGE-MAKERS OF NAUGATUCK—The axletree of its industry. As their wheels roll off may the money roll in!

Responded to by D. R. Stevens.

THE EMPLOYEES OF MESSRS. STEVENS & Co.

Responded to by B. A. Wooster.

OUR HOST—His *board* is excellent. May his patronage equal his des(ert).

Responded to by J. P. Stone.

WOMAN—The main spoke in the wheels of our existence, may they never want a fellow (fellow).

Responded to by G. F. Gardiner, Esq.

THE OCCASION WE CELEBRATE.

Responded to by C. H. Carter, Esq.

THE WORKING-MEN OF AMERICA, THE FARMER AND MECHANIC—The true nobility of our republic, whose ancestry is recorded in living words upon the pages of history.

Responded to by F. H. Thompson, of Bridgeport.

The company having enjoyed themselves with the festivities of the evening, and in interchanges of good will towards each other, returned home after midnight, highly delighted. May all concerned find in this "re-union" their mutual interest greatly promoted! Subsequently the following cards from the employees have appeared in the public prints:

A CARD.—We, the lady employees of H. Stevens & Co., adopt

this method of presenting our cordial thanks for the liberal entertainment given by the firm at the Scoville House, in Waterbury, on Monday evening, the 16th inst. And also of acknowledging our appreciation of their benevolent consideration of us, in thus amply providing for our enjoyment. May the Author of all good reward them, with not only temporal, but the choicest of spiritual blessings!

Per order.

Miss L. A. BISHOP,  
Miss J. C. ROOT,  
Miss M. R. WOOSTER,

} Committee.

Naugatuck, Jan. 10, 1860.

A CARD.—We, the employees, take this opportunity to return our sincere thanks for the kindness and liberality of our most worthy employers, H. Stevens & Co., in extending to us the compliments of their supper at the Scoville House, Waterbury, Conn., on the evening of Jan. 16th, 1860. May their success in business equal their generosity.

N. T. SCOTT,  
B. A. WOOSTER,  
E. JEWETT,  
S. N. BEECHER,  
F. S. ANDREWS,  
GEO. HOADLEY,  
L. S. SPENCER,

} Committee.

#### AN ENGLISH CRITICISM OF AMERICAN CARRIAGES.

OUR transatlantic cotemporary, "The Carriage Builders' Art Journal," in its issue for December last, has indulged in "a criticism as is a criticism," and throws out some ideas which, on either side of the Atlantic, may certainly be considered as not very flattering to our national vanity, nor commendable of our taste as active members of the great cosmopolitan coach-making fraternity. At the first glance or two of examination we felt inclined to view the article as a piece of ponderous merriment, by way of contribution towards our Christmas "fixins," and kindly sent from "Unele John" to make "Our American Cousins" laugh while we "all take tea," without any further "wait for the wagon." At the close, however, the writer gravely asserts that his "remarks" are "not offered in any spirit of ill-will, but of genuine comparative merit, in an article of luxury, economy, and taste—three qualities very difficult to combine." Something Decemberish about this, without being so convivial as we would prefer for a wintry season. But, we here present the remarks of our critic:—

Among the great variety of objects of manufacture, there are none more capable of displaying taste and judgment than carriages; and none are subjected to a more severe test of public opinion, being confined to no locality or class. And while we cheerfully give our Transatlantic brethren every credit for their skill and good judgment in every other article of manufacturing enterprise, we must be allowed to except that of Carriage Building, upon which public opinion has set its seal. That they are marvelously light, extremely well put together, most ingeniously constructed and designed for their purpose, we readily grant; also that the draught is so light as to lessen fatigue

to the horse, is a valuable point gained. Yet these advantages are gained by an absence of quiet good taste, a want of proportion, a deficiency of that solid, substantial quality, that forms the characteristic of an English carriage. If we are to define the matter, then, we take these spider-looking vehicles, having enormous high wheels, with scarcely any difference in the height, before or behind, with spokes less in diameter than an ordinary broom handle; against this the body is extremely shallow in height, giving it a low, squatty appearance, rather of a vulgar aspect. The absence of frame work, in the carriage part, leaves great spaces unfilled up, looking meager and deficient; while the iron work, from its wire-like form, makes one tremble to think of a collision with the high and rough stones which we are bound to travel over, without daring to think what might be the consequence in the event of one of those rencontres to which most drivers are liable, particularly in our streets, and occasionally on the roads. These, taken separately and combined, influence the general opinion entertained, and confine their use to a few amateurs to whom novelty is a charm; but for hard work, or constant use, unless on very smooth roads, we confess we think them impracticable. The first impression they give is a want of importance, an absence of dignity, inconsistent with the idea altogether of a carriage, let its quality be what it will.

Notwithstanding our surprise at this unusual display of explanatory condescension in a British periodical, we begin to recognize the fact that our cotemporary is in earnest, and this makes the matter all the more laughable in reality. But, if such be the English view taken of the present state of American carriage-making, we claim the right of being heard before such a sweeping condemnation can be allowed to impose upon the people of any other country.

We have not the slightest idea of quarreling with any of our cotemporaries; for a certain old lady is usually considered to have remarked that "there is no accounting for tastes." We aim at the cultivation of a correct standard (or adaptable standards) of taste, as well as our English cousins. We are sure to fraternize in that endeavor. In fact, at page 145 of the present volume, we have already given place to some remarks by a writer in the "Carriage Builders' Art Journal"—understood to be Mr. T. R. Starey—in which that gentleman has happily concurred in defining "taste" to be "the perception or power of perceiving and relishing excellence; the faculty of discovering beauty, order, congruity, proportion, and symmetry." Good! We lock arms, and march along with our English cotemporary on that platform. We shall try to keep step for step with him, even if we do have something to say when he gives us an unexpected poke in the ribs.

In another part of the article we had already extracted and given at page 145, the writer has well observed that "in every case, *fitness*, or adaptability of the carriage to the purpose for which it is required, should be the first consideration; without this, whatever may be its beauties of form or harmony of colors, it must result in a failure."

Now, those are our sentiments, exactly; and we cannot help feeling entitled to know what "taste" is best suited for our people in our own country, especially as we have not the slightest doubt that our cotemporary in England is a correct exponent, and judicious authority upon all such matters in that country.

We should like to introduce some of our American carriages to the tasteful observation of Mr. Starey; for we have an "idea," somehow, that he has never seen one. Perhaps we may be mistaken; perhaps not.

In the extract above, our readers will perceive that the assertion is made, that our American carriages show "an absence of quiet good taste, a want of proportion, a deficiency of that solid, substantial quality, that form the characteristics of an English carriage." Here we have a wholesale but decisive comparison. A disinterested observer will naturally inquire—what is this thing to which our carriages are thus invidiously compared? In Mr. Adams' work on "Pleasure Carriages," he has given a description which ought to be, we suppose, an unobjectionable answer. He says, page 209, "The frame work and wheels look a huge mass of timber and iron work, much too heavy for the light load which is suspended on it. The wheels appear to project apart from it, for no apparent reason." Two sentences further, Mr. Adams observes, "Altogether, it is a barbaric mass, which is only redeemed from positive ugliness by the harmony of the various curves as a whole; and, to produce this harmony, there are yet no ascertained rules," etc. In the same paragraph, further on, Mr. Adams says, "The size and weight of a carriage ought to be proportioned to that of the horse or horses intended to draw it, as well as that of the person or persons intended to ride in it, and also the locality and season it is intended for," etc.

Now, this is just what "our folks" have been doing. In this country of "magnificent distances," we are all, more or less, according to the requirements of either business or pleasure, concerned in the use of riding vehicles. With a comparatively new country, we naturally associate riding or driving among the essentials of education; and, in fact, almost every American boy or girl, without being remarkably "fast" in their ideas, can tell the various recommendatory qualities of this or that style of vehicle as it passes by in the panorama of "life on the road."

American ingenuity has availed itself of modifications from all European or Indian styles, ranging from a London lord-mayor's coach, to a Neapolitan fisherwoman's carriole. Undoubtedly, the heavy and close English carriage is the parent of the majority of our four-wheeled vehicles for riding purposes. Its closed-up sides, all except the sash in the upper half of the door (and even that sometimes had a Venetian blind), its foot-board and sling-bands from the roof behind for the footman to

stand on and "hold on" with, its enormous perch and axle-trees, and its very official-looking hammer-cloth seat for the coachman,—now give us the idea of some state funeral or animated four-post bedstead, going along by the aid of some concealed mechanism under the valence. It is a singular fact that, in England, where these close-covered carriages, with their rumble-come-tumble motion, originated, all attempts to lighten them by paneling or by the substitution of glass or leather in their sides, have never been followed by popular approval. The chariot, having only one seat, and that in the back half of the body, allows of glass in front of the occupant; but when hackney coaches and chariots are standing at the same coach-stand, the former are usually preferred. The introduction of the modern cab is the only change that has made any great impression upon the old, slow-coach patrons. The English carriage-makers removed the painted or varnished panels, and allowed the top to hinge back in two halves. Many of the aristocracy approved of the idea, and gave orders liberally for what was thus called a landau. Chariots were next modernized by the manufacturers, in a somewhat similar style, and these vehicles were then called landaulets; but the great masses yet clung to the idea that to ride in a carriage was to be protected from all rude observation, not even allowing the wind to blow upon the occupants.

Another singular fact in the English view of carriage riding, is very significant. The carriage-builders in England gradually introduced a lighter kind of four-wheeled vehicle, calculated to seat four persons, but without any perch, and mounted on elliptic or grasshopper springs, instead of the old-fashioned C springs. This style of coach was named the "Clarence," after the Duke of Clarence, subsequently William the Fourth, one of England's most popular monarchs; but it has never been viewed with much favor except by the aristocracy of the agricultural districts, who readily observed its many improvements. The Clarence is yet frequently found in the large cities, with the old C springs purposely put on to please popular prejudice! Let not the English carriage-builders (the English term still applied to them) be blamed for this backward dignity of their customers, whom it is their business to please. We doubt if Queen Victoria herself, popular as Her Majesty unquestionably is among all classes, could change the notions of her city-bred subjects upon the awful solemnity of "riding in a carriage!" Mr. Shillaber's "omnibus" soon became a favorite; Mr. Hansom's "patent-safety cab" was readily adopted for street use, especially after Henry Dolby's improvements were added; but woe to the man who lays a hand on "the carriage" in England!

These matters we leave to be settled between the English "builders" and their customers, being quite content in observing the fact that whenever any European

parties have imported English carriages HERE, they usually contrive to part with them at a "marvelously low figure." Ask Mr. Leeds, of New York, or any of our most "eloquent" auctioneers. Let facts do the footing up of our argument.

A very slight acquaintance with the prevailing styles of our private or public vehicles, especially those intended for professional utility or as "pleasure carriages," soon causes the European visitor to confess and extol their elegance as well as strength—their lightness as well as utility. The hackney-coach of London, and the fiacre of Paris, although nearly out of date by the general substitution of cabs or cabriolets, yet retain a clumsy and antiquated look to the eyes of an American traveler, for the reason that they are usually the remains—at second hand, as it were—of some faded "gentility." Whereas, in New York, or nearly all our large cities, the vehicular conveyances used (even by our hackmen or livery-stable keepers), are generally manufactured expressly to their order; or, if bought at a sale of some private gentleman's effects, are sure to be not very far behind the most modern styles, in either structure or finish. Scarcely any features among American manners or customs are more nationally characteristic than the ever-fresh and always-improving styles of our wheeling or sleighing vehicles. "Public opinion has set its seal," and so has the world's opinion, as we have here shown, decidedly in our favor. What astonishes us is, that as an editor, endorsing the opinions of others, he should have so inconsistently contradicted himself, while finishing off the old year with such a gratuitous fling at his American cousins. We wish he would come here, and take a walk with us in Broadway, on some fine afternoon.

In the octavo volume published by Mr. Adams in 1857, he comfortably asserts, and complacently prints, that "English carriages, take them altogether, are the most perfect carriages constructed in any part of the world;" but he immediately adds, "The mistake has been in confounding high superiority in existing art with absolute perfection. To show that English carriages are still far short of perfection will be no very difficult task." He then proceeds to "show" this fact, with his usual clearness when not trying to disparage any other nation. But our carriage-makers have been PROVING the fact any time the last twenty or thirty years; and we shall continue honestly trying to make further improvements.

Like our European brethren, we have been engaged in solving the problem of the old joker, who quaintly described a carriage as something with "a large wheel following a smaller one without being able to overtake it." We all know the fallacy of such locomotion. Dickens himself has made a loquacious cab-driver describe a "pair of big wheels," as forcing a horse to "go on" against his will. The American relish of humor is as decided as our

perception of geometrical principles; and, whatever blame may properly belong to us as a nation, that of being backward in invention, or clumsy in execution, is not usually attributed to "our folks," we believe. Next to the extraordinary discrepancies between the English Editor's "notions" and Mr. Adams', is his most extraordinary ignorance of the present state of carriage-making in this country. Editors are usually supposed to be posted up on the current affairs of the times. Let us give the culprit the benefit of a doubt. Surely, the editor did not observe the above; or, is it an English joke.

### FAMILIAR LETTERS FROM THE CRAFT.

CLEVELAND, TENN., JAN. 14th, 1860.

MR. E. M. STRATTON:—*Dear Sir*, The number of the Magazine you sent me came to hand in due time; with the contents of which I am very well pleased, with one or two exceptions, which does not amount to much, if anything. I think it would better meet the approbation of Southern manufacturers, if there was a plate of a light carriage in each number. \* \* \* I saw a notice in the Magazine concerning the different tracks. The wagon-makers here, make their wagons to track five feet two inches. I have been making my carriages track five feet from center to center.

Yours, respectfully,

H. F. McCAMY.

JAMAICA, L. I., NEW YORK, Feb. 6th, 1860.

MR. EDITOR:—Last August, while working in a neighboring village, I saw the July number of your valuable Magazine. I was about coming here at the time, and intended to put my name on your subscription list the first time I came to New York. A week after being here I was taken with rheumatism, and have been confined to the house ever since, which made me, from want of means, incapable of fulfilling my desire; but my former employer kindly send me his to read, and I verily believe the Magazine has done more to alleviate pain than much of the medicine I have taken.

In your last number I noticed an article on "carriage-making in Boston, with a criticism on 'western work'" &c., that I could not make tally with my ideas of consistency. The writer says:—"No sensible man would dare to charge them (*i. e.* Western workmen) with incompetence or inexperience; for perhaps there are no better workmen found than those employed in large manufactories." In the next column speaking of "Western trimmers," he says:—"If they were to come to Boston they would find, in the first place (these competent and experienced workmen), that it would be difficult to do the work at all; and if they could do it, though having one third more money for the same kind of vehicle, they would not earn as much by two, three, or four dollars per week." "*If they could do it*," implies that they could not do it, though "there are no better workmen found" than Western workmen.

Again in the following column, he continues:—"We hear men, who have worked upon [Western blacksmith work], blow and tell how they used to iron a coach each week, and rip and tare, spout and splurge, about the old fogyism of Boston workmen, who cannot do it in less than

from six to eight weeks. These very men, in trying to imitate Boston work, cannot do it themselves in less than three weeks;" and when finished "it is only fit to grace the wood-work of a scavenger's cart." Men who cannot be charged with incompetence or inexperience; men who as workmen have no superiors, and yet can only make work "fit to grace a scavenger's cart," sounds (to me) like a gross contradiction of terms. The writer says, Boston trimmers get one third more for a job than is paid in Western shops for the same work; but a Western trimmer completes his work in twelve or fourteen days, and it requires from four to six weeks for a trimmer to finish the same job Boston fashion. Now, to sum up, we will split the difference between twelve and fourteen days, and call it thirteen days that it takes a "Western trimmer" to do his work. Making the same average with Boston time (between four and six weeks) would give five weeks, or thirty working days. Thus we find, from the writer's own statement, that a Boston trimmer gets but one third more for thirty days, than a Western one does for thirteen days.

I do not know the price for the work in trimming a "Western coach," but will put it down at twenty-five dollars; one third of twenty-five added to twenty-five makes thirty-three dollars and thirty-three cents, for the Boston trimmer's thirty days, or one dollar and eleven cents per day, while a Western one would have twenty-five dollars for his thirteen days, or one dollar and ninety-two cents per day.

Here seems to be two horns to a dilemma, either of which will *hang* the writer. If you make that twenty-five dollars more for the "Western" job, you increase the difference in price of day's work in favor of the Western trimmer; and if you let it stand as it is, we have this fact established that Boston trimmers, work for the same wages that hod-carriers frequently get in the city of New York; and yet the writer tells us that when Western work is made for the market, men "have to be smart, and nothing but smart, to earn a comfortable livelihood," &c.

If all the writer tells us is true we should judge that men in "Modern Athens" have to be smarter, *and nothing but smarter*, to earn a bare subsistence, even upon custom work; but as there is so much difference between their work and ours, perhaps their logic may be equally different, so that these (to me) conflicting statements may be perfectly reconciled, after all.

A FRIEND OF LOGIC.

Extracts from a letter dated COLUMBUS, O., JAN 17, 1860.

MR. EDITOR:—In previous letters I have said something of the utter prostration of business here, and the unprecedented scarcity of money. Well! things are in the same state of fix, *only more so*. I will give you one example of the condition of carriage-making, from which you can judge of the *exact* condition of affairs. In the principal establishment of this city, where they usually employ from seven to ten painters, there are now at work one journeyman and one apprentice. In the smith-shop there are two fires going instead of six or eight, and the same state of things exists in the wood and trimming shops. Add to this the fact that they do not get on an average two dollars per week *in money*, and you can easily imagine the sum total. This is not exaggerated a particle. \* \* \* Your Magazine has friends here, who would willingly

take it, *if they could*. I think, that times are improving in other Western localities; for I have seen several advertisements for hands, in Cincinnati papers within a week past, and I have had two offers of situations in Indiana myself. It may be, this financial malady is local with us.

Extract from a letter dated THURSDAY, C. W., Jan. 23th, 1860.

MR. E. M. STRATTON:—*Sir*, It has been some time since I heard from you, and I am anxious to know whether you are alive and kicking. I took the Western Coach-maker's Magazine until it got to be good for nothing, then I received a prospectus of a new one to be started in New York by you. I received the first number, but did not feel at liberty to take it. [Was you "afeerd" of that tall Son of York?] I was showing it the other day to some of the craft, and they seemed anxious to have it; so I said I would write and see if you was in existence. I would like to know if you can furnish back numbers. Please send the Magazine from January, 1860, *and if it suits, I will take it and endeavor to pay for it, and if not you will hear from it.*

N. F. C.

[We are happy to say that we are not only in "existence," but can furnish *all* the back numbers complete, from the commencement, *when* we receive the money therefor. We don't want to hear from the Magazine afterwards, *if it should not suit*; for *shocks* of this kind have already deranged our nervous system. Consequently we cannot send it without the money *in advance*.—ED.]

#### INVENTIONS APPERTAINING TO COACH-MAKING AT HOME.

##### AMERICAN PATENTED INVENTIONS.

January 10. AN IMPROVED TOOL FOR CUTTING ROUND TENSORS.—L. A. Dole (assignor to himself and Albert R. Silver), of Salem, Ohio: I claim, first, the arrangement of the flanged cylinder A, face plate D, radial rests E E E, and cutter F, in the peculiarly constructed adjusting ring C G, substantially as and for the purpose set forth.

Second, The combination of the right-hand screw-thread H, formed on the inner circumference of the flanged cylinder A, the left-hand screw-thread I, formed on the circumference of the gage-shank and the set-nut F, substantially as and for the purposes set forth.

Jan. 17. AN IMPROVEMENT IN ATTACHING THILLS TO VEHICLES.—Adam Odell, of New York City: I claim the use of the flat-headed bolt C, in combination with the clip-holder A, and thill-iron B, made and operating in the manner and for the purposes set forth.

Jan. 24. AN IMPROVED ARRANGEMENT OF STEAM ENGINES FOR PROPELLING STREET PASSENGER CARS.—Robert H. Long, of Philadelphia, Pa.: I claim, first, placing a steam engine and boiler, constructed and arranged as described, on the platform of a city passenger railroad car, in a manner substantially as specified.

Second, Placing the pinion F, upon the frame of the engine, thus permitting the engine to be brought close to its work; and the whole to be used in combination with a city passenger railroad car, for the purposes set forth.

AN IMPROVEMENT IN ATTACHING THILLS TO VEHICLES.—Andrew J. Ritter, of Rahway, N. J.: I claim the combination of the clevis C, and the thumb-screw D, with the shaft-eye K, and the half journal box H (which is secured to the axle of the vehicle); the parts K and H being so constructed that when the clevis C, which is secured to the shaft-eye by the bolt and nut E F, is in the position shown in Figs. 1 and 2, the part K and H will be coupled together; but when the thumb-screw D, is

loosened, and the bottom of the clevis C is pulled forward and upward toward B, the parts K and H will be uncoupled.

AN IMPROVEMENT IN MACHINES FOR POLISHING LEATHER.—Richard A. Stratton, of Philadelphia, Pa.: I claim attaching the agate to a vibrating arm, J, which is so controlled by an eccentric, K, or its equivalent, operated by and moving simultaneously with the shaft which imparts the vibrating motion to the arm, that the agate is depressed to the curved bed of the machine during the inward movement of the arm, and raised from the bed during its outward movement, as specified.

AN IMPROVEMENT IN CLEVIS FOR ATTACHING WHIFFLETREES TO VEHICLES.—Levi S. Taylor, of Laneville, Ill.: I claim the clevis, or its equivalent device, constructed substantially in the manner described, and for the purposes fully set forth.

AN IMPROVED WRENCH.—John E. Neill, of the United States Navy (assignor to E. S. Pomeroy, of New York City): I claim the use of the jaw B, in combination with the collar C, when said jaw is constructed and operated in the manner specified.

AN IMPROVEMENT IN LOCOMOTIVE VEHICLES FOR RUNNING ON ICE OR IN WATER.—Norman Wiard, of Janesville, Wis. (assignor to J. Townsend, of New York City, as his trustee): I claim, first, The combination of the following elements, viz., a water-tight boat, capable of floating on runners or skates, to run on ice, and sustain the boat thereon, and so connected with the boat as to turn for steering, substantially as described; and a single traction or propelling wheel placed centrally between the runners or skates, to act on the ice, for the purpose of propelling the boat when its runners or skates rest on the ice, substantially as described. I am aware that the traction wheels fast on one and the same driving axle, have been combined with runners and a boat; but in such case the runners were not swiveled to the boat, to change the direction of the line of travel, and the two wheels being fast on the same axle, would resist any means employed for steering; and hence I do not wish to be understood as claiming, broadly, the combination of traction wheels with runners or skates, and a boat, but to limit my claim to the combination above stated.

Second, I also claim combining the traction or propulsion wheel and the boat, by interposed springs or equivalents thereof, that the wheel may be self-adapting to any inequality of surface, whilst the runners rest on the surface of the ice, as set forth.

Third, I also claim, in combination with the boat and runners or skates, the mechanism substantially as described, for lifting the runners from the ice, by lifters which sustain the weight, substantially as described, whereby the runners can be prevented from becoming fastened by frost to the surface of the ice, when at rest, as set forth.

Fourth, I also claim the stationary runners attached to the bottom of the boat, in combination with the movable runners or skates at the sides, substantially as and for the purposes set forth.

Fifth, I also claim constructing the traction wheel, substantially as described; that is, periphery a sharp cutting edge, to penetrate into the ice, to prevent the boat from moving sideways, and thereby admit of using runners smooth or rounded, when such periphery is combined with lateral projecting wings, having cutting edges to penetrate into the ice, and take hold thereon from traction, substantially as described.

Sixth, So connecting each of the movable runners or skates with the boat, that each may turn in a horizontal plane on an axis, substantially as and for the purpose described.

Seventh, I also claim combining with the turning runners or skates, and with the steering chains, the tension or adjusting blocks, or equivalents, substantially as and for the purpose described.

Eighth, And I also claim connecting the ice-penetrating brake by a hinged rod or arm to the boat, substantially as described, in combination with the connection of it with the toggle joint lever, or the equivalent thereof, with a steam piston, substantially as and for the purpose specified.

Jan. 31. AN IMPROVEMENT IN CARRIAGE SPRINGS.—John M. Forrest, of Norfolk, Va.: I claim a carriage spring, constructed, arranged, and operating substantially in the manner described.



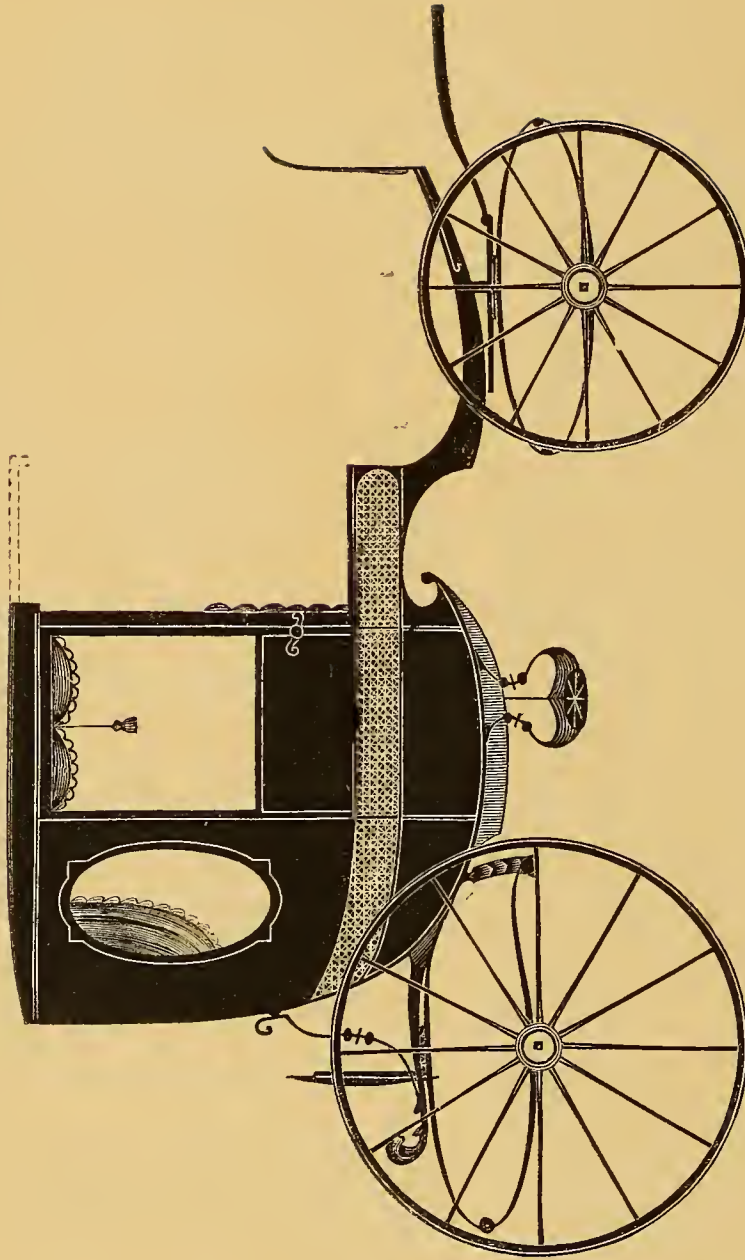

IRVING'S TRANSPOSE ROCKAWAY.—(1st Form.)— $\frac{1}{2}$  IN. SCALE.

*Engraved expressly for the New York Coach-Maker's Magazine.—Explained on page 209.*



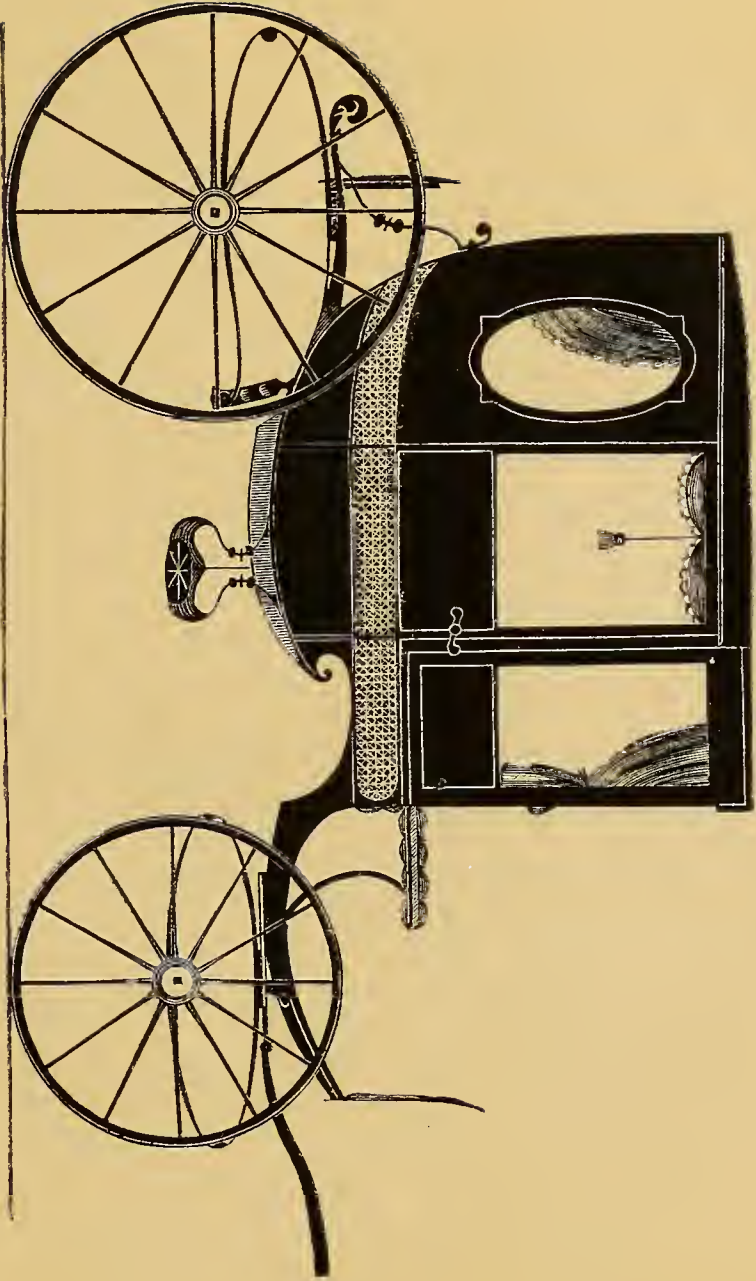

IRVING'S TRANSPOSE ROCKAWAY.—(2D FORM.)— $\frac{1}{2}$  IN. SCALE.

*Engraved expressly for the New York Coach-Maker's Magazine.—Explained on page 209.*





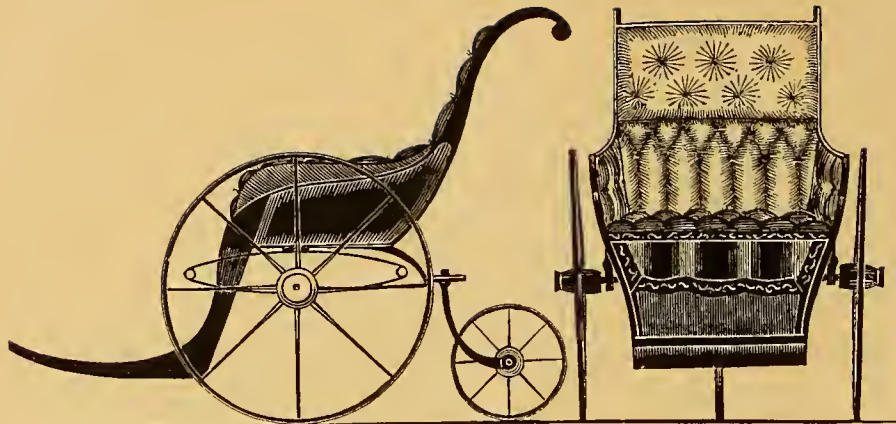

INVALID CHAIR.— $\frac{1}{2}$  IN. SCALE.

*Engraved expressly for the New York Coach-Maker's Magazine.—Explained on page 209.*

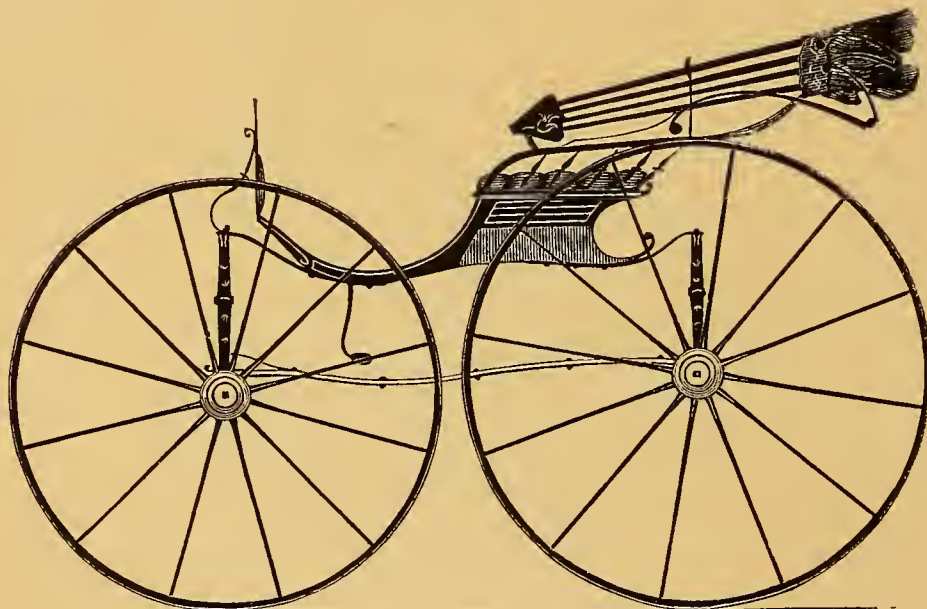

PHAETON.— $\frac{1}{2}$  IN. SCALE.

*Engraved expressly for the New York Coach-Maker's Magazine.*

*Explained on page 209.*

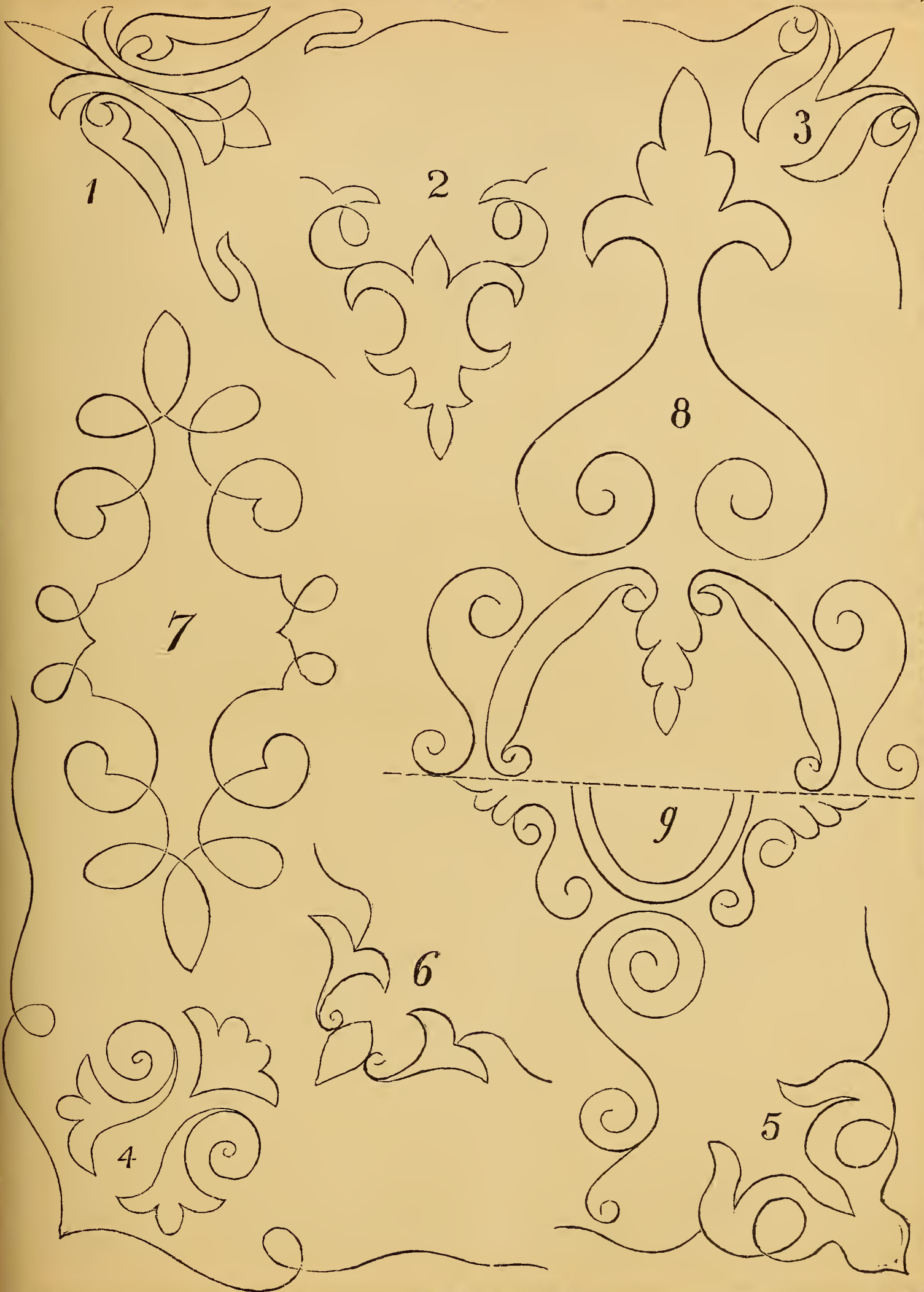

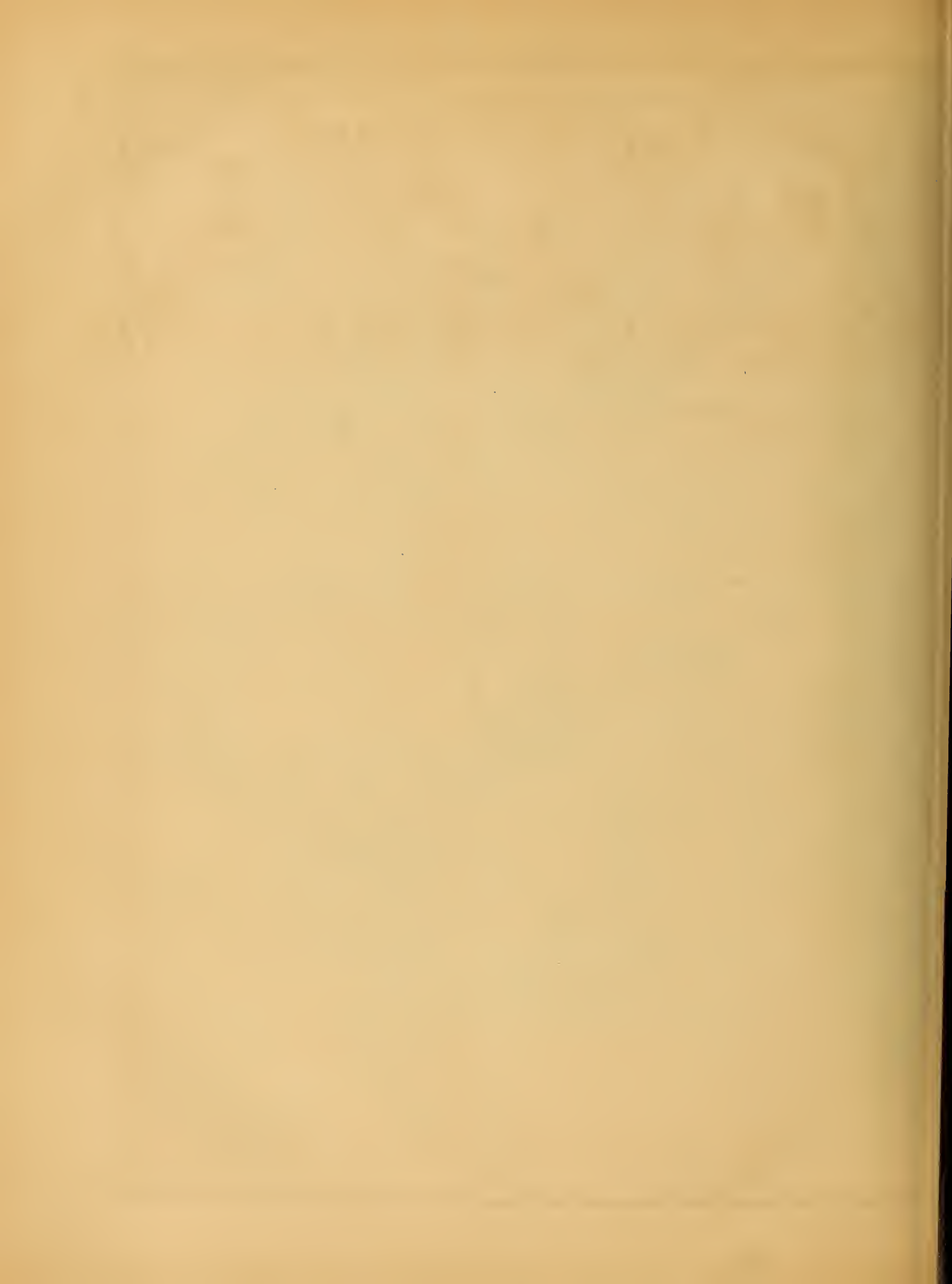



DEVOTED TO THE LITERARY, SOCIAL, AND MECHANICAL INTERESTS OF THE CRAFT.

Vol. II.

NEW YORK, APRIL, 1860.

No. 11.

### Miscellaneous Literature.

#### COACH-MAKING HISTORICALLY CONSIDERED AND INCIDENTALLY ILLUSTRATED.

BY THE EDITOR.

##### CHAPTER XXI.

John Clapp, the Bowery inn-keeper, poet, and wag—The Albany city ordinances against driving "slees," &c., faster than "a stap"—The first coach owned in New York—General Society of Mechanics and Tradesmen organized in 1785—New York coach-makers in 1786—9—Carriage-shops "near the gaol"—Livery stables in 1786, and some of their "legal rates"—The first coach built in Philadelphia, and some of the "bosses" named—The first carriage built in Newark, N. J., sold in New York—Only six coach-makers in New York in 1793, fifteen years after the close of the Revolutionary war.

WITHOUT offering any apology for digression, we think the following extract is of sufficient interest to recommend it to the reader. As early as 1697 there was one John Clapp, who appears to have been poet, inn-keeper and wag, in the Bowery, "2 mile from the Post office." He tells us, in an old almanac printed by Bradford, the earliest printer here, among other things, it is now one year "since the first Hackney coach was made and kept in this city, by *John Clapp*, for the accommodation of all Persons desirous to hire the same. From the Post office in New York to *Jo. Clapp's* in the Bowery is 2 mile (which generally is the bating place where gentlemen take leave of their Friends going so long a journey), and where a parting glass or two of generous wine

'If well apply'd makes their dull Horses feel  
One spur i' th' Head is worth two in the Heel.'

No doctors at this period visited their patients in a carriage; all "footed it."

In this same year (1697), on the 22d of December, an ordinance was passed in Albany, N. Y., in which "it is Proclaimed y<sup>t</sup> all Persons who enter y<sup>e</sup> City with slees [sleighs] and horses, horseback and oyrwise, shall not ride faster than foot tap throughout y<sup>e</sup> streets, upon Penalty of three shillings for each offence." Two years afterwards, in 1699, "It is further Resolved and thought convenient that a Proclamation be proclaimed y<sup>t</sup> no Carman shall hereafter use a Cart until such time they have Mr. Mayor's Lycence therefore, upon Penalty of forfeiting y<sup>e</sup>

somme of six shillings, and y<sup>t</sup> no person or persons shall drive there horse or horses in slees or oyrwise through y<sup>e</sup> streets of this city faster than upon a stap, upon penalty of forfeiting y<sup>e</sup> somme of three shillings, *toties quoties*." It would be interesting, in this day of fast horses, to know exactly how far these laws against driving "slees" were regarded by our "boy" Knickerbockers in early times. But these were days when scarcely any rode. The earliest coach *owned* in New York city is said to have belonged to Lady Murray in 1745, when to go to market required, that Dutch should be understood and spoken. From this period until 1786, the date of the earliest city directory, while as yet New York contained but very few inhabitants, we know but little of carriage making. A long and bloody war had been going on in this country for several years, and only three years of peace had yet been afforded the citizens for recovering from its effects. The carriages most in demand since 1776 had been *gun-carriages*, with the making of which the coach-maker is seldom troubled. How much of the history of the earlier struggles of the "craft" at this period sleeps in the earth with our ancient brother, Stephen Steel! How much might be learned of Isaac Jones,—and the two Warners! how was business with them? Peace to their memory! To what degraded uses have their "establishments" now been doomed! alas, alas!

Since penning our last chapter, further research gives us reason to infer that the coach-makers did not, as we had supposed, have an organized and distinct society of their own in New York. Some of their number probably were embraced in the General Society of Mechanics and Tradesmen of the city and county of New York, established on the fourth day of August, 1785. The declared intention of that society, was "to promote universal friendship, confidence, and good understanding among the various descriptions of mechanics, as far as to prevent litigation and disputes among tradesmen, to promote mechanical knowledge, and afford relief to its distressed members, and to establish funds to enable the Society to carry their laudable designs into effect." This has continued until the present time. They have a very extensive library under their charge, and a school in a flourishing condition, at 472 Broadway.

In 1786 there were but three coach-makers' shops in New York: Stephen Steel, 81 Kings street (afterwards

called Pine street, and known in 1797 as number 2); Isaac Jones, and James & Charles Warner, in Broadway, before that street was numbered. One Jas. Hearne had at this time a livery stable at 56 Gold street. Steel appears to have died in 1798; as we find the following year, that widow Catharine Steel lived at number 2 Pine street.

Three years after, in 1789, we find that Cornelius Van Anler (no number), in Barelay street (afterwards No. 30); Wm. Collet, 4 Wall street; Robert Manly, Dye's street; Thos. Parsons, 81 Broadway; Jas. Kellet, 1 John street; and Charles Warner, 6 Great George's street (afterwards called Broad street), were added to the above number of coach-makers. Also, Thomas Barron, at 38 Broad street, hung out his sign as "coach-painter and print seller," whilst his name-sake, and probably his brother—John—kept a shop at 52 Broad street, where "coach and sign painting" was "done" to order.

Among the "wheelwrights" of this period we find John Lawrence, corner of Chambers and Little Chapel streets; Adam Fisher, 4 First street (now Christie street); John Hallet, 121 Queen street; Hall, corner Church and Barclay streets; John Poalk, and Jacob Blane, in Greenwich street; George Taylor, Eagle street (?); and Christian Pullis, in Chambers street. Jas. Warner, at No. 6 Great George's, and doubtless brother to Charles, the coach-maker above named, both carried on a saddle and harness-making business in the same building. It will be seen, hereafter, that they, for a short period, were in partnership as coach-makers in the same place, which is stated to "be near the gaol." An anecdote in this connection may not be out of place. In 1825, there stood a carriage-shop in *old* Fairfield, Conn., occupied by a man named Thorp, who was famous for hiring hands *cheap*. In the same place stood the county jail, where in those interesting times a man who was "too fast" was generally "brought up *all* standing" for debt, and confined until he paid. These (and some of them were carriage-makers), were permitted to go within certain limits during the day. "Old Thorp," as he was called, saw in this a chance for a "spee," so he, who before was *without* said limits, had a shop built *within* them, where an unfortunate "brother chip" might have a job to earn a little spending money while he was paying off old debts *in jail*. Some of our readers *may remember the—shop!*

At the period (1789) of which we are writing, it would seem that Chas. & Jas. Warner, of Great George's street, "near the gaol," kept a livery-stable in connection with their other business, as did also Jas. Hallet, at No. 1, and John Ross, at No. 5 John street. Besides these, James Hearne, 56 Gold street, — Huek, 81 Wall, and Pat. Shay, 5 Courtlandt street, were "Proprietors of Coaches." The stand for all coaches at this time was at the Coffee House, corner of Wall and Water streets. The legal rates of fare were, "to take up and set down one passenger within one mile 1 shilling; two passengers, 2 shillings; to the two mile stone and 'round by Cumming's (a tavern in Water street at that time), for a party, &c., 6 shillings; Horn's Tour, 8 shillings; Lake's Tour, 10 shillings, and for each hour the carriage may be detained on the route, 2 shillings; for waiting on company in the city, per hour, 3 shillings; to Murray's, half a day, 14 shillings; to Graeey's tavern, 16 shillings; to Apthorp's tavern, 38 shillings; to Harlaem, one day, 38 shillings; to do. half-a-day, 30 shillings; to the twelve miles Fort, one day

32 shillings; and to King's Bridge, 15 miles, one day, 40 shillings. Some of these men were afterwards known as prosperous coach-makers in New York, having increased in wealth with the increase of custom.

Mr. Charles Perrie, an aged coach-maker of Philadelphia, states that in 1790 David Clark, on Sixth, between Market and Chesnut streets, built a coach for Samuel Powell at a cost of about \$800, which was considered a very extravagant price for that day.\* After Mr. Powell's death it became the property of his widow, and afterwards fell into the hands of her nephew, John Ham Powell, who afterwards deposited it in Wood's Museum, where it has since been reported as having once belonged to our illustrious WASHINGTON, on what authority we are not advised. The maker of this carriage died of yellow fever in 1793.

The names of those engaged in the business in Philadelphia, in 1790, were David Clark, Alexander Penman (both Scotchmen), Jas. Simmons, Robert Feeling, Thomas Eagle, Wm. Hunter, and James Kerr. From all we have been able to learn, coach-making in Philadelphia was rather in advance of the same business in New York. This was owing, doubtless, in some measure, to its comparatively inland situation, and removal from the actual ravages of the Revolutionary war. It will be remembered, too, that New York, for some time, was in the possession of an enemy who had no certainty of keeping it, but which, in fact, acted as a check for the time being on all mechanical advancement.

In 1796, it is stated that there were only 7,904 inhabitants in New York city. About this time, Daniel Ross went from New York and commenced the coach-making business in Newark, New Jersey, where he built a carriage "for the family of Kearney's." Previous to this nothing but the old-fashioned "chairs" hung upon wooden springs, had been made there. Ross's carriage, although made in the plainest manner, is said to have been "substantial in all its parts." Soon after this experiment, an English coach was brought to Newark by the Kemble family, having been purchased in Philadelphia. This excited a good deal of curiosity; and it is stated that Robert B. Canfield, an old carriage-maker still living, but who at the time had just commenced the business, and only made work of the humblest pretensions, took patterns of its several parts, examined it well, and determined to imitate it as well as he could. Being without the tools necessary to make some parts of the carriage, Mr. Canfield started on foot for New York in the morning, returning to Newark in the evening with the tools wanted. He immediately set himself to work, and soon produced a coach as nearly like the English prototype as possible. He afterwards

\* In several publications—*The Historical Magazine* among them—we have observed the following passage: "The first carriage built in America is said to have been made by a man named White, in Dorchester, Massachusetts, for a private gentleman in Boston, in 1805. This was copied from a kind of English chariot, made much lighter, and said to have been creditable to the builder. It was, however, found to be much cheaper to order them from Europe, on account of the high price in material and excessive cost of wages. A plain kind of wagon, with the simplest description of finish and trimmings, was made in the cities of New York, Boston and Philadelphia." The most charitable construction to be found for the writer's statement, is in the supposition that he has confounded the fact that the first carriage built in Massachusetts was in 1805, with his belief that it was the first built in America. Our investigations may serve to set him right upon this subject.—Ed.



took it to New York and offered it for sale as his own manufacture. This story the "Yorkers" would not credit, as they thought a carriage of such skillful workmanship could not have been made in a "country shop." He succeeded, however, in selling it finally, and these proceeds supplied him with his first capital for the extensive business he afterwards carried on.

In this year we find that the afterwards distinguished coach-maker, Abram Quick, appears as a journeyman painter, residing in Cross street. Three years after, he was residing at No. 6 Fair street. It is not until 1816 that he figures in the city directory as a coach-maker, from which he retired in 1826. We shall have occasion to speak of him again.

In 1798, two years afterwards, Jos. Powell, 73 Broad

street; Thos. Parsells, 145 Broadway; Cornelius Van Allen (Van Anler), 30 Barclay street, were the coach-makers then in business. Charles Warner, at No. 7, and James, his brother, at No. 9 Barclay streets (both having removed from 6 Great George's street), having dissolved, each kept a coach and harness-making shop on his own account. A. Peel was coach and *chair-maker* at 26 Broad street. At this time 9,113 names only are found in the city directory. Up to this period very little had been done in manufacturing "carriages." Mostly were made the wooden spring chairs (*chaises*), a rude kind of wagon, and jobbing. The finer kinds of carriages—such as they were—were still all imported from Europe. We shall have more to say about the New York coach-makers in the next chapter.

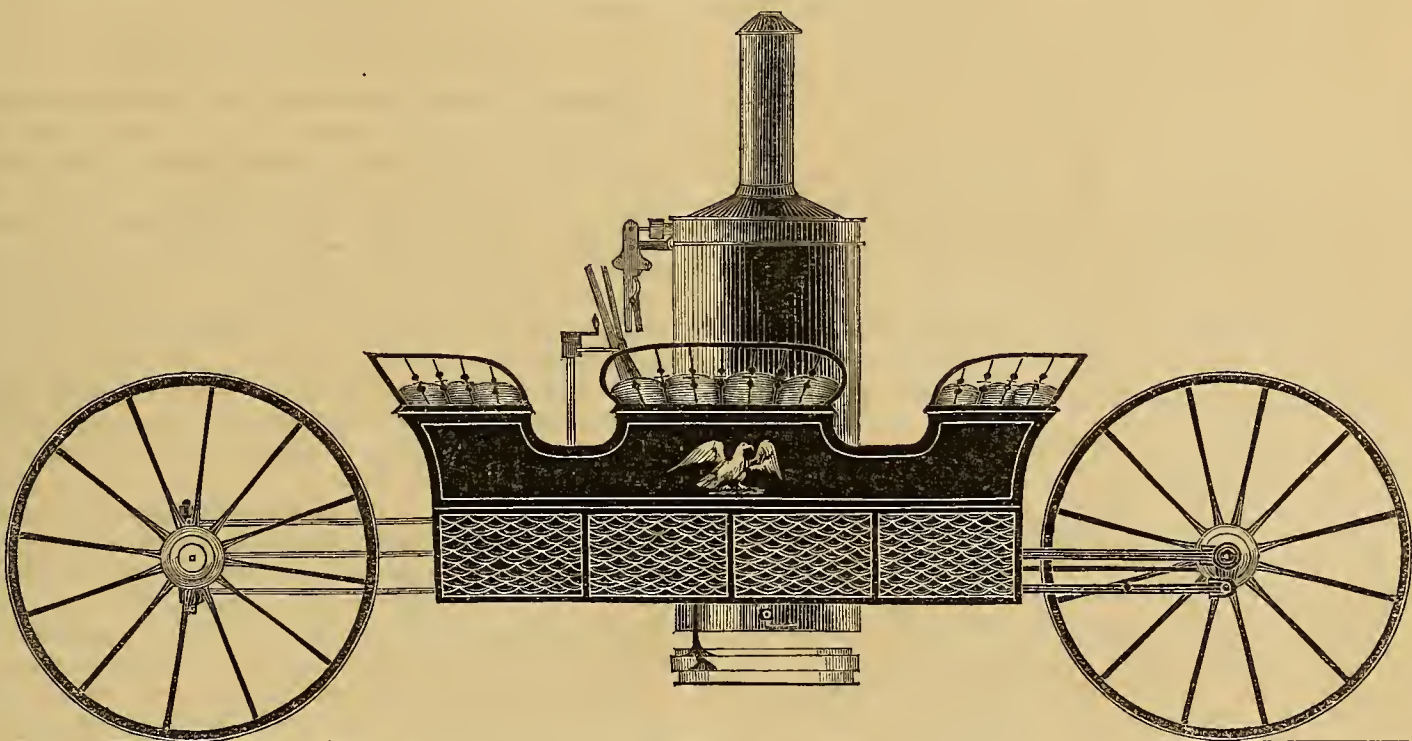

NEW AMERICAN STEAM-CARRIAGE FOR COMMON ROADS.

For the New York Coach-maker's Magazine.

### FISHER'S STEAM-CARRIAGE.

The engines of this carriage are like those used on locomotives. The connection between the engine-shaft and driving-axle is a new combination, devised to avoid the rocking and pitching that would be produced by the oblique action of the connecting rods of a common locomotive, were the springs of the flexibility necessary for common roads. The axle is held at a constant distance from the engine-shaft by radius rods; and the power is transmitted from the engine-cranks to the axle-cranks by parallel rods. These rods have universal joints to allow of the irregular motions produced by inequalities of the road. This combination allows the use of springs as flexible as can be used on carriages that are drawn.

The driving wheels are fast on the axle, as in locomotives. In order to compel one of them to slip when turning a corner, the steering wheels are placed well forward, and considerably loaded, which insures certainty in steering at moderate speed. The connection of the front axle by projecting springs, placed in the centre of the carriage,

gives the required distance between the axles, and allows the use of high wheels, while the centre of gravity is low.

The steering is by a screw, turned by a hand-crank, operating through bevil wheels. From the screw a rod connects to the axle, a foot from the centre.

The framing consists of a box with internal partitions, 7 feet long, 5½ feet wide, and 14 inches deep, made of sheet iron or steel, and fastened by angle irons and riveting.

The springs are each a single leaf, 5/8 to 3/4 inch thick, 5 to 7 inches wide in the middle, tapered nearly to a point at the ends, and 70 inches long. Half the springs are inside the carriage, and the projecting ends take hold of the axles.

The boiler is of the upright tubular kind; heating surface 75 square feet; cylinders 5 inches bore by 10 inches stroke; wheels 54 inches diameter; axles 12½ feet apart; total length 17 feet.

The English steam carriages of the experimental period, from 1829 to '41, had their drivers loose on the axle and held by clutches; and one wheel was unclutched when turning,—an unnecessary complexity and trouble.

Their wheel-base was too short, and their steerers too little loaded, to turn securely when both wheels were clutched. Their steering was by a rack and pinion; which was insecure. Their boilers were over or behind the hind-axle; which jolted them, and took much power to carry them. And, for want of a good parallel connection, they could not suspend their engines on easy springs; in consequence of which, it took more than twice the power to run at high speed that would have been used if they had been well suspended.

Their boilers were expensive and inefficient, and not durable. That of Ogle, whose carriage attained 30 miles per hour, vaporized  $4\frac{1}{2}$  lbs. of water per square foot of surface per hour, and 6 lbs. per lb. of fuel. Macerone's did about as well; but locomotive boilers vaporize 15 lbs. per hour per foot, and 9 lbs. per lb. of fuel. This boiler is applicable to common roads; but the upright flue boiler is deemed as efficient, and more convenient for this use.

As a general indication of the improvements in locomotives, most of them applicable to steam carriages, it appears by official reports that the cost of power on the Liverpool and Manchester railway in 1833 was six times as great as it was on the New York Central in 1853. If under such circumstances steam carriages had failed, they might still be expected to succeed now, even if the invention remained essentially the same, and only proportions and workmanship had been improved, as is the case with the locomotive; but their advocates claim that they did not fail mechanically, but were defeated by prohibitory tolls and other opposition, from which the legislature refused to protect them.

In this country it has been presumed that the roads are not good enough for them; and several carriages have been found insufficient in power to run fast upon our inferior roads. But a large, unfinished carriage built for the inventor, on the plan here presented, has run between two milestones on a gravel turnpike at the rate of  $22\frac{1}{2}$  miles per hour, and has surmounted the resistance of very poor roads. And responsible machinists will build on this plan, and guarantee an average speed of 12 miles per hour on good gravel roads, if orders are offered. There is no reason to doubt the practicability of going over almost any roads at a fair speed, and on the post roads at a speed unattainable by horses. The only doubt is as to the economy for common carrying at the old rates of speed. And until this doubt is removed by actual working, for some time it is hardly expected that orders will be given.

But it is supposed that there are a few, who will not insist on proof of cheapness, if they can be assured of high speed, and of as much safety and controlability as horses have at equal speed. It is for the purpose of interesting carriage builders in getting up a light carriage to suit such persons, that this plan is laid before them.

The wagon here represented is expected to weigh about 2,200 lbs. with fuel and water; and to carry 10 persons, or an equivalent in goods; or to draw a family carriage at the speed of good horses, when the roads are in the usual summer condition. When loaded to weigh 3,000 lbs., it will have 1 foot of boiler surface to 40 lbs. total weight; the large carriage referred to has 1 foot of boiler to 70 lbs. weight; this one is therefore expected to run much faster; and if very high speed be desired a larger boiler may be made.

The cost of such a carriage, with a leather top, well

finished, has been estimated at \$2,000, by Col. Hoe, the machinist, who intended to build one for his own use, and probably would have done so had his business not become pressing.

The inventor considers that with the same propelling mechanism, a carriage may run a third faster or slower in consequence of excellences or defects as a carriage; locomotives have varied as much, in consequence of alterations affecting them only as carriages; and for this reason he wishes that the talent of carriage-builders, as well as engineers, should be exercised upon the invention. Those who wish to look into the matter are invited to address the inventor,

J. K. FISHER,  
No. 234 East Broadway,  
NEW YORK.

For the New York Coach-maker's Magazine.

#### A TRIP TO NEW YORK CITY.

TAKING the cars at Auburn, in the A. M. train—I have forgotten the hour and minute—we soon arrived at the beautiful city of Syracuse, which, probably, received its classic name from the celebrated capital of Sicily, mentioned by the Evangelist Luke, Acts, xxviii. 12, where St. Paul spent three days, when a prisoner on his way to Rome. Nothing worthy of special notice struck my fancy here; but the dark, gloomy culvert, through which we dashed *under* the Erie canal, with terrific speed; when imagination was endeavoring to unravel the difference between such a sudden exit from the light of mid-day and a leap into some unknown, dark abode. How rapidly one's thoughts revolve, when so suddenly snatched from the pure light of heaven!

Passing through Rome,—not the Rome to which students are so accustomed to allude in their harangues,—and Utica, and Schenectady, without making any observation worthy of record, I soon found myself in the beautiful State Street of the capital city of the Empire State—Albany, on the west side of the Hudson River, about 150 miles from Manhattan Island, whither I was bound.

The first step here was, to go to the State Agricultural Hall, a splendid building, to record my name, and to see our mutual and esteemed friend, Col. B. P. Johnson, the indefatigable, prudent, and zealous Secretary of the N. Y. State Agricultural Society; and to go through the different departments, and take a peep at the machinery, implements, curiosities, &c., which have been collected from various parts of our own State, and from all parts of the civilized and the *uncivilized* world. A journey of three hundred miles merely to visit and examine the works of State at Albany, is by no means lost. In one large part of the Agricultural Hall are three galleries, one above the other, where improved farm implements, and those not improved, are kept. Here may be seen the rudest, most ill-shapen, and inefficient implements which the world ever saw, in the shape of scarifiers and plows. There, it seems to me, is the veritable old bull plow, with wooden standard, wooden mold-board, wooden landside, and wooden everything but the steel point, which my father was accustomed to use more than forty years ago. Near it stands one of Emery Brothers' cast-iron plows, of the latest improvement, which exhibits a very great contrast in plows. There is a bundle of old sticks, and pieces of implements, resembling a lot of flood-wood, which have been collected in Hindostan, and carefully forwarded to

the Agricultural Hall, as most rare curiosities. Here are all sorts of farm implements, and machinery, and tools, and patent fences, &c., which have been forwarded by their proprietors, gratuitously, to be deposited in the archives of the N. Y. State Agricultural Hall.

Among the lot of rare curiosities from the Old World, was the ruins of a *wheel*, which beggars all description of everything in the line of wheels that I have ever met with. The first thought is, on seeing it, that it is a relic of the antediluvians, and had survived the Noachian deluge without total destruction, although about one third of it had crumbled back to dust. It exhibited great signs of having been a faithful servant while it was in a condition to revolve, as its bearings were almost, and I do not know but entirely, worn out. I could not conceive, with my limited knowledge of wheel-vehicles, what could have been its office, unless it was to support the forward end of some three-wheeled wheel-barrow, which the sons of Noah had hitched their steers to, when breaking them in, while the good old preacher of righteousness was erecting the noble ark. I never before met with any style of vehicle or machinery, in the shape of wheels, but what I could without hesitancy, determine how they were made, and think that I could make one just like it. But, at this piece of mechanism, my powers of imitation demur. Then the next thought was, to take a draft of it. But I soon learned that pencil, pen, ink and paper, in any shape, failed entirely to show, as they really are, the curiously wrought rim, made of strips of bent wood about as large as the hoops of a flour barrel; and the heavy portion which subserved the purpose of spokes, and the curious center—not nave, nor hub, nor hole through the center—with iron flanges on each side, with a point or iron center, a few inches long for bearings, on the sides, which were as rusty and scaly as if it had recently been exhumed from the ruins of some ancient, demolished city. I thought if some of our great carriage-makers would forward some of their fine buggies or wheels, to be placed by the side of this relic of antiquity, with their cards on them, to say nothing of the contrast, it would be a good advertisement for them. Leaving scores of articles of great interest, we passed into the

#### GEOLOGICAL HALL,

where specimens of every group of stone, shale, slate, and ore in this State, and many from other localities, are labeled neatly in glass cases, and arranged with no little order and care. Of course, everything, save some huge piece of a meteoric stone, which no visitor would like to pocket, is kept under lock and key; but still, everything can be examined about as well as if one could take it in his hands. What a place for a geologist! Here we may take specimens of stones, which we find about our country residences, and compare them, and learn exactly by what name they are recognized, and to what group they belong, &c.

As we enter the next gallery, the first thought is, that we have been introduced to Van Amburgh's Menagerie; and as those ugly-looking, huge bears glance their fiery eye-balls at us, and that blood-thirsty panther seems ready to spring upon us, and that prowling wolf seems to grate his teeth, and to prepare for a choice morsel out of our bodies, which we are so careful of, and as those crows and rooks seem just ready to spread their wings and come down to pick our bones, which have been left by the animals just mentioned, we begin to recoil, and look around to see if there is not some back-doorway, where it is pos-

sible to escape. See that sly fox just ready to pounce upon that little group of sleeping partridges. Innocent little creatures! We almost wished for "Col. Shall-I-Sneeze's" revolver, to serve him as Col. Crocket did the "Possum on the stump."

In the next case, we recognized scores of the feathered songsters of the grove, and "the swallow twittering from the straw-built shed," and the little chick-a-dee, seemingly just ready to sing, clear as the sound of an eolian harp, *Summer, summer!* Surely, thought I, our taxidermist has performed a noble work, and done it well, too; and if he could only breathe into the black bill of that crow, the familiar voice of *Caw, caw, CORN*, or give the wonted agility to the wings of that humming-bird, or make those little robins sing with their accustomed sweetness, we might call him a deity.

From this delightful place, which is open, free to all visitors, I went to the Capitol, to see how our Members-of-Assembly were figuring; and thence into

#### THE STATE LIBRARY,

where I spent about half a day, very pleasantly and profitably. Large catalogues of all the books are lying on the tables; and by telling the clerk the title of any book you would like to see, he will immediately hand it to you; and you can examine its contents, unmolested, as long as you desire.

Tearing away abruptly from hundreds of other things of great interest, I took the Hudson River Railroad cars, and reached the great metropolis of our country about ten o'clock at night. Like a bewildered stranger in a strange labyrinth, I inquired the way to Number 106 Elizabeth Street, to the office of THE NEW YORK COACH-MAKER'S MAGAZINE, and spent a few days, or nights rather, in the Editor's very pleasant, intelligent, and agreeable family. Everything seemed prosperous, happy, and in good style and order; and I found the Editor to be an estimable citizen, a good scholar, and, what cannot be truthfully said of the editors of every Magazine, an *honest* man, in whom subscribers to that work need not fear to repose implicit confidence. From New York—having taken a short trip into New England—I returned home again.

S. EDWARDS TODD.

LAKE RIDGE, TOMPKINS CO., N. Y.

For the New York Coach-maker's Magazine.

#### STORY OF A SABER-CUT.

BY JAMES SCOTT.

I NEVER see an unsightly scar on a human face without being seized with an eager desire to pry into its history; and the indulgence of this strange mania has made me the repository of many curious stories, some of which are not without interest. During a recent steamboat-trip up the Ohio river, I was thrown into a state of feverish excitement by discovering, among the crowd of passengers on board, a tall, melancholy-looking gentleman on whose face appeared the most *terrific* scar I had ever seen; it traversed the left cheek, diagonally, from the point of the eye to the corner of the mouth, giving to the care-worn features a look of ferocity totally at variance with the mild light of his soft, gray eye, and the deep lines of thought that

furrowed his high, intellectual forehead. Here was a rare subject on which to exercise my pumping talent; and at it I went. I soon managed to become acquainted with the owner of the cloven cheek—on a steamboat introductions are superfluous—and, wretch that I am, successfully wound myself into his good graces, broached the subject, and my perseverance was rewarded by hearing the following tale:—

“The wound that left this ugly seam on my face was not received accidentally, as you seem to suppose; it was a sword-cut, and as there is rather a romantic story indirectly connected with the incident, I will give you the whole history. We will light a cigar and take a seat on the hurricane-deck, where we will be uninterrupted by the crowd; come!

“Few young men,” he commenced, “start in the race for wealth and position in society with a fairer prospect of ultimate success than I did. At the age of twenty-one I came into possession of two thousand dollars in cash; which I invested in a stock of dry-goods suitable for country trade, and commenced business in my native place, an inland town, distant some ninety miles from the commercial metropolis of the Union. Fortune smiled upon my efforts, and at the end of three years my stock in trade and outstanding claims footed up, independent of my indebtedness, the handsome total of eight thousand dollars. This was a most gratifying result, particularly as I was about to change the state of bachelorhood for that of matrimony, and it was necessary to withdraw a portion of my capital from my business to purchase and fit up a cage for my pretty bird. Annie Ross *was* pretty, and possessed all those nameless graces of mind and person that not only attract but retain affection; it is true, she had her faults, but love is blind, you know. How all the best feelings of my nature were wrapt up in that woman, God and my own heart only know! In all my day-dreams of future happiness on earth, aye, and in heaven too, she was ever by my side; and even amidst the stern realities of dollars and cents—the ledger and yard-stick, her face was present. This all sounds very foolish *now*, but I was young then—very young, for that was fifteen years ago; these gray hairs and deep wrinkles of mine would have it fifty,—but it is only fifteen.

“A severe frost, that came late in the spring, killed the crops in our vicinity, and made it impossible for many of the farmers to pay their debts contracted at the stores in town, and made payable after harvest, as is customary. One of our largest mercantile firms was forced to succumb to the pressure, and make an assignment to New York creditors; who sent out an agent to see to their interest in winding up the affair. This person, Mr. Le Blond, was a handsome, dashing-looking young man, free and easy, yet elegant in manners, scrupulously neat in dress, and possessed in a remarkable degree of the faculty of ingratiating himself into the good graces of all with whom he came in contact. I have said *all*, but I must qualify that assertion, for *I* did not like him from the first. There was something about the man that repelled me; perhaps it was the covert sneers he occasionally let fall about our rustic manners and customs, or some gilded sarcasm aimed indirectly at our village beauties; but, be that as it may, I soon had cause to *hate* him with a bitter, deadly hatred. He gained easy access to society, and was very popular with the gentler sex; indeed, his polished manners, and fine conversational powers, were irresistible attractions in

a community like ours, where manners were formed after the provincial standard.

“It was with a pang of mixed sorrow and regret that I noticed something akin to a flirtation springing up between this scion of fashion and Annie Ross; none knew better than I that one of the most glaring defects of her character was a fondness for admiration, and I trembled for the result of this growing intimacy. But then, she was mine in heart and soul, and the only jewel that glittered on her taper fingers told of our betrothal;—why should I fear? it was unmanly, weak; yes, and I grew *weaker*, until my brain reeled, and inward fires I had not strength to smother, scorched and shriveled up my heart.

“The flirtation went on finely—gloriously. It became the staple of conversation in town, and I was pointed at and pitied. Tortured to desperation, I sought the traitress and demanded an explanation. The interview was a stormy one—she haughty and scornful—I firm and fiery. It ended in wrath. The ring she wore was hurled at my feet; and crushing it to atoms beneath my heel, I left the house, with fury in my bosom and a malediction on my lips. It was well for Le Blond and my soul's salvation that he did not cross my path that day, for I would have slain him without compunction.

“The tempest spent its strength and went down. There were occasional bursts of agony; but they, too, died, and there came a calm—the calm of despair.

“A rumor reached me that they were to be married; I expected it and was prepared. I knew the man did not love her; at least his love was mercenary—an affair of dollars and cents—for her father was wealthy; a fact that had never influenced *my* wooing, but I knew him and his cold-blooded aims—he was a villain of the darkest dye! During a lull in the scathing tornado that snapped my heart-strings, I had written to a young friend of mine—a person whose wide-spread acquaintance in the city warranted the application—for information respecting the moral character and standing in society of Le Blond. The information, I told him, if used at all, will be to effect an honorable purpose, namely—to save a lady friend from forming an alliance that may result in life-long misery. The answer was to the point; thus ran the paragraph that told the tale: ‘Le Blond is unworthy the acquaintance, much less the love of a pure woman. Honorable persons of both sexes shun him in this city, and nothing but the influence of his brother, an estimable man of high standing in the mercantile world, secures him the position of clerk which he now holds. Were he to even *speak* to a sister of mine, I would cowhide him within an inch of his life.’ Armed with this document I bided my time, and it came.

“One afternoon, Mr. Ross, the father of Annie, called at the store and wished to speak with me in private; leading the way to a back room, I pointed to a chair and asked him to proceed. He was sorry, he began, very sorry, that the engagement between his daughter and myself was broken off; but man proposes and God disposes. The difficulty, he was assured by Annie, was irreconcilable; he was advanced in years, and could not expect to sojourn on earth much longer; so the wish nearest his heart was to see his daughter provided with a protector ere he departed—to see her united to some honorable man who would cherish her with the tender care she needed; for she lacked, he was sorry to confess, that strength of

character necessary to a successful career among the conflicting elements of society. Mr. Le Blond, a person whom he regarded very highly, had proposed for her hand, and was accepted; considering the peculiar relationship in which I stood to his child, he had thought it proper to acquaint me with the fact, and hoped I would receive the information, and act upon it, in the same spirit of good-will in which it was given.

"I suffered him to proceed to the end without interruption, and when he had finished, I said—

"Whatever feelings of resentment I may entertain towards Miss Ross, shall not influence my action in this unfortunate affair. I intend, Sir, to *prevent* this marriage, and that, too, in a spirit of good-will so far as you and yours are concerned."

"Prevent! what do you mean by that, Sir?" he exclaimed, his face flushing with anger.

"This letter," I answered, handing him the one I have referred to, 'will explain my meaning fully; if its contents do not satisfy you, write and inquire for yourself; you know the author of this and his standing in society.'

"He tore it open and read, the color, the while, gradually fading from his face; and when he reached the end and the paper dropped from his grasp, no corse was ever whiter.

"I offered him a glass of water, he drank, and it revived him. The blood flooded back to his cheeks and mounted to the roots of his hair.

"The infernal scoundrel!" he at last vociferated, gasping for breath, and springing from his chair, 'but I'll spoil his game! I'll—well no matter; Annie shall be yours yet, Sir; this villain shall'—

"Hold! my dear Sir, hold!" cried I, interrupting him, 'make no calculations of the sort, for I swear to you, by all I hold sacred, my suit for your daughter's hand is ended, now and *forever!* Much as I have loved her—much as I still love her, spite of reason and conviction—there can never be even a passing recognition between us; never, never!

"Heaven help me! this is hard!" said the old man, bitterly; 'but the loathsome viper that has crawled to my very hearthstone to sting me, shall suffer for this; why, even now, he defiles my house with his presence; but his time is short—he shall hear from me, aye, I'll expose him to the whole town—I'll show him up in his true colors, dog that he is!' So saying, he seized his hat and rushed from my presence.

"My feelings, when left alone, were various and conflicting—agonizing; there was but one thought left me that did not stab, and that was the conviction that I had done my duty.

"An hour or so had elapsed, and having some letters to mail, I started for the post-office, but had not gone far, when I heard my name called in a short, angry voice; and turning, perceived Le Blond approaching me at a quick pace, his face purple with passion, and eyes gleaming with ferocity. Stopping in front of me, and shaking his fist in my face, he hissed from between his clenched teeth—

"So, my rustic meddler, you have been stuffing that old fool with lies, have you? your *kindness* shall not go unrewarded, my verdant tale-bearer. Take *that!*'

"As he spoke, he had drawn a horse-whip from under his coat, and never did blade descend in mortal fray with greater fury than it did on my shoulders. Ere he could

repeat the blow I had him by the throat; my blood was fired to madness, and laughing, as fiends may laugh at the tortures of the damned, I raised him from his feet and dashed him to the earth; then, wrenching the whip from his grasp, I lashed him until his clothing was cut in shreds as with a knife. Recovering his feet by a desperate effort, and heedless alike of his hat and the jeers of the crowd his howls and curses had collected, he ran like a whipped dog, and in less than an hour he was on the way to the metropolis; but he never reached there. In a few days the principal of the firm that employed him arrived in town, when it became known that the fascinating Le Blond had absconded to parts unknown, carrying with him a large sum of money that had accrued from the bankrupt sale.

"Annie Ross became invisible in society, and her father looked ten years nearer his grave. Poor old man! I pitied him, even amidst the wreck of my own long-cherished hopes.

"Bereft of my greatest incentive to industry, I became discontented, and fretted under the restraint my business imposed; life became a burden of misery, nor could all my efforts at self-control bring one hour of peace to my tortured soul. This state of feeling unfitted me for any employment, so I sold off my stock of goods for what I could get—invested the principal part of my capital in real estate, and bade farewell to the place of my nativity—the place where hope died and was buried.

"After a month or two spent in erratic journeyings from place to place, I arrived in New York, disgusted with the world and particularly so with myself. The endless variety of amusements the city afforded, had no power to sooth my woe or kill memory; and it is quite likely I would have tried a plunge in the bay had I not accidentally stumbled upon a remedy for my mental malady. While wandering up the Bowery one day, my attention was arrested by the stirring music of a fife and drum; it was a party of recruits for the war we were then carrying on against Mexico. They were parading the streets with flying colors to attract aspirants for military glory into their ranks. On the instant, I conceived the idea of joining them; the thought pleased my morbid fancy, and I acted on it: in half an hour I was duly enlisted to do battle against the enemies of my country. The men with whom I thus became associated were mostly from the rough strata of society, easy-going fellows with no particular fancy for work, and just sufficient of the animal in their organizations to make activity of some sort a necessity. It is true, there were some honorable exceptions—men fond of adventure who were impelled by hopes of promotion, glory, and all that sort of thing; and then there was a sprinkling of misanthropes like myself, who were tired of everything else and became soldiers for a change.

"The novelty of my new life pleased me; the 'drill' I entered into with spirit, and soon mastered, both in theory and practice; the officers were a gallant, energetic set of men from the captain down; and the lively interest they showed in bringing the men into a proper state of discipline, gave ample promise of efficiency in the field.

"Of the voyage to Vera Cruz I will say nothing; it makes me sick, even now, to think of it. The leading incidents of the march of detachments, under General Pierce, to reinforce the victorious Scott, who had paused at Pueblo to gather his strength for a dash at the capital, are matters of history with which you are familiar. The

corps to which I belonged had early shown a superiority over most of the raw levies in point of discipline, and when danger was near, we were among the first called upon to avert it. We soon received 'the baptism of blood,' for clouds of those irregular troops called guerillas hovered like vultures upon our flanks, ready to swoop down upon the advancing train at every favorable opportunity. Our ears soon became used to the hiss of bullets, and our eyes to the flashing shine of lance and saber. Our hearts became hardened to the free use of the deadly bayonet, and our nerves were as steel to poise and 'sight' the musket. It is curious how one's whole nature will change with a new occupation, and adapt itself to the associations and circumstances with which one is surrounded. On more than one occasion, when the company roll was called, I was startled to hear my name uttered, and find myself surrounded by armed men, whose reckless, unshaven faces were but counterparts of my own. But such is life; and the change from the yard-stick to the musket—from the counter to the camp—are but simple illustrations of its uncertainty.

(To be continued in our next.)

For the New York Coach-maker's Magazine.

### A DRAMA IN ONE ACT.

BY I. BUSTER, JR.

#### DRAMATIS PERSONÆ.

Tom,—A jour., who prides himself on his skill in carving.

Boss,—Who prides himself on the artistic excellence of the work made at his establishment.

#### SCENE—*Workshop.*

[Enter Boss, who approaches Tom's bench.]

Boss :—Are those carved spring-bars I ordered, finished yet?—they want them in the smith-shop.

Tom :—Yes, sir; here they are. [Hands them to Boss, who examines them critically.]

Boss :—You call that *scratching* carving, do you? Why, sir, it looks like chicken-tracks on a snow-bank!

Tom :—[Indignantly.] Yes, sir-r-r, I call that carving—*good carving*. Perhaps the style is new to you—it will look better when it is primed.

Boss :—[Sarcastically.] It will, eh? Well, you needn't mind *priming*—I'll *fire* them without it. [Throws them into the stove.]

Tom :—[Savagely.] Burn them if it suits you; but I will *charge* you for them, sir—*charge* you full price; see if I don't!

Boss :—[Getting riled.] All right! *Charge* me, if you feel like it, but don't undertake to *fire* me, or I'll *discharge* you!

Tom :—[Dryly.] Don't trouble yourself, I'll *go off* without it; but I must say that you are the meanest man I know of!

Boss :—[Furiously.] I'll *ram* that down your throat.

Tom :—[Defiantly.] That's your *aim*, is it? pitch in!" [Both seize spokes—grand combat—both down—tressel smashed—ditto grindstone—tableaux—curtain drops.]

Music—Donnybrook Fair.

PLEASURE, like quicksilver, is bright and shy. If we try to grasp it, it still eludes us, and still glitters. We perhaps seize it at last, and find it rank poison.

## The Home Circle.

For the New York Coach-maker's Magazine.

### FANCY'S DREAM.

BY LUA DELINN.

WEARY! I'll drop the oar,  
My tired hands fold,  
Shut out life's deafening roar,  
Dream of a sunny shore,  
Sauded with gold.

Golden the sands be, where  
Fairy feet fall,  
Sunbeams are glancing there—  
Ah! that entrancing air,  
Memory's call.

Led by a loving hand,  
Happy I roam  
With my own chosen band,  
Once more in fairy land,  
Childhood's bright home.

Leaves, elustering thickly,  
Over me fling  
Shadows, which lifted be,  
Oft as they dance with the  
Breezes of spring.

In deep woods whose shadows lie  
Solemn and still,  
Through valleys—o'er hills high,  
Everywhere, tireless, I  
Wander at will.

Tones, soft as music's flow,  
Fall on my ear,  
Eyes, lit with love's warm glow,  
On me their glances throw—  
Joy to be here!

Ah! now the dream is o'er,—  
Sullen and cold  
Flow back life's waves once more,  
With their dull, heavy roar,  
Just as of old.

But smoothly plies the oar,  
Stronger I seem,  
That I have roamed once more  
On childhood's sunny shore,  
E'en in a dream!

For the New York Coach-maker's Magazine.

### THE PLEASURES OF RURAL LIFE.

BY A RURALIST.

"Would you be strong? Go follow up the plow!  
Would you be thoughtful? Study fields and flowers!  
Would you be wise? Take on yourself the vow  
To go to school in Nature's sunny bowers.  
Fly from the city; nothing there can charm;  
Seek wisdom, health, and virtue on a farm."

ANON.

How good it seems to get home again, in safety, after being whirled through the country, from city to city, over hills, vales, and streams, and along the brow of frightful precipices, where we are liable to be dashed to atoms in a moment; and how good it seems to sit down by one's own quiet fireside, in some delightful, rural retreat, where

no hum of business, no rattling and rumbling of wheels, no hurrying tramp of horses, nor hasty tread of the busy throng, breaks upon the ear.

I never could like a city life. It is not and cannot be denied, that the inhabitants of our large villages and cities enjoy very many most excellent privileges and advantages, not only for education, but for the comforts of life. But, when we come to talk of the *pleasures* of city life, and compare what passes for pleasure with the solid pleasures of *rural* life, how incomparably superior the latter are to the former! In large cities, one's vision is bounded by shops, hovels, and magnificent edifices, on almost every side; but when we get beyond all these things, and Nature's broad and ever-varying domain meets our vision, how enlivening and cheering the scene! what rich clusters of rural pleasure rise up before us, when old Earth dismantles her bosom of its snowy whiteness, and we behold

"The tender grass come creeping everywhere."

How pleasurable to go out into the fields, and ramble on the mountains, and pluck the wild flowrets, which come peeping up in every verdant nook and secluded glen! What music is more harmonious and delightful than the murmuring, babbling brook? When Nature is robed in her greatest loveliness, and fields look gay and smiling, and trees and shrubs, and plants and flowers seem to vie with each other in beauty and magnificence, who can behold the scene and not richly enjoy it?—when

"The bright queen of Spring, as she passes the vale,  
Leaves her robe on the trees and her breath on the gale,  
The landscape outstretching, in loveliness lay,  
On the lap of the year, in the beauty of May."

Who, among all the sons of Adam's race, would not choose for his quiet abode some rural district, away from the bustle of the busy throng, where he can sit down without care, and gather his dear ones about him, and in the experience of his feelings, imbibe copious draughts of domestic happiness, having the feathered songsters of the grove, with their mellifluous music, for choristers, and finding

"Sermons in stones, books in the running brooks,  
And good in every thing."

In rural walks, good health, rosy cheeks, and countenances as fair and lovely as the tints of the rosy mornings of brightest Summer, enliven the quiet domicile, which those who are cooped up in a large city know nothing of.

O, give me the quietness of the country, while life prolongs its feeble light; and when I lay me down in the long-resting place of the gloomy grave, waiting for the dawn of that glorious day, when all the ransomed ones shall be caught up to meet the holy Redeemer in the air, let the feathered choir warble their melodious notes of gladness among the tall grass which bends over my narrow abode; and let the little flowers bloom in silence there, and cast their fragrance on the ambient air.

#### GRATUITOUS ADVICE.

WHEN your friends are laid up with the rheumatism, always press them to come over and take tea with you. While such acts of kindness entail no expense, they procure for you a larger reputation for sympathy and neighborly kindness. With proper discrimination, there is nothing that pays a better profit than "goodness of heart."

## Pen Illustrations of the Drafts.

For the New York Coach-maker's Magazine.

IRVING'S TRANSPOSE ROCKAWAY.

*Illustrated on Plate XXXVII and XXXVIII.*

THIS carriage takes its name from the circumstance that it can be made to assume different positions.

On plate XXXVII it represents a single coupé Rockaway. The dotted roof-lines in front represent the place of the sliding-roof, which may either be drawn out or pushed in at pleasure. The glass-front placed between the front pillars can also be removed at will, when it will assume the form of an open front coupé.

On plate XXXVIII is represented the same carriage in the form of a very comfortable family coach. The alterations are made by drawing the sliding-roof forward and removing the glass front out to the front part of the front seat. It is secured by thumb-screws on the front of the roof, and by iron pins at the bottom through the seat. The glass frames in the side are similar to those in calesches. Judgment must be used in fitting these under the roof, so as to prevent the water from getting inside the carriage. The driver's seat is simply a board hinged on near the bottom of the shifting-front. When this is not in use, it may be turned up under the glass rest-rail, and trimmed for the back. When in use, it is supported by irons fastened on the inside of the rockers. To a person wishing a change of carriage this will be found very convenient. There is no humbug about this plan, but from it can be made a good and practical job, which may be proved by experiment.

J. IRVING.

For the New York Coach-maker's Magazine.

INVALID CHAIR.

*Illustrated on Plate XXXIX.*

As there has been nothing of this kind given in the magazine as yet, for our sick friends, I now present this to your readers as one of the many designs which might be got up for such a purpose. This is designed for the attendant to push ahead by a turned handle framed across at the scroll on top of the back. By thus pushing and turning it any way you please, the back wheel adjusts itself to its proper position, so as to allow the invalid to get into the seat with ease. It might be raised behind so as to allow the front to come down on the floor, for the same purpose.

J. I.

PHAETON.

*Illustrated on Plate XXXIX.*

THE phaeton which accompanies this number has some points of originality about it that will make it valuable to the manufacturer of this kind of carriages. Should lightness be an object, where the price warrants it, the body may be made with panels; where these are secondary considerations and cheapness is demanded, it can be made with solid sides. In either case, the draft will furnish all that may be required by the practical carriage-maker, without going into further details.

## Sparks from the Anvil.

### ORNAMENTAL DICKEY-SEAT STAY.

VARIOUS have been the devices ingenuity has contrived for giving a light and tasty appearance to the seat-stays of bretts, caleches, &c., in this country. While our co-



temporaries across the Atlantic still, as their fathers did, retain the clumsy-looking extension of the rocker as a support for their dicky-seats, in most cases, Yankee taste has provided substitutes at once ornamental and efficient. The latest improvement in this direction is the one here illustrated. Instead of being *all* iron, as in the one figured on page 133 of this volume, *this* is wood and iron in combination. In the first place, the smith shapes his stay from a flat bar of iron, to fit the desired pattern. After this has been done,

holes are drilled at suitable points for screws, which screws, on being turned into the wood, secure it to the iron plate. This wood being on the outside of the plate, and afterwards handsomely carved, presents to the eye the beautiful architectural finish we have endeavored to illustrate. This at the first view would appear to the practiced eye as rather heavy, compared with the light stay heretofore in use, but when compared with other parts of the carriage as a whole, it will be seen to present a decided improvement in this respect.

### MANUFACTURE OF CAST-STEEL.

THE inventions which have been patented within the last few years, having for their object the production of cheap steel, have been so numerous that, doubtless, there is some ground for the conclusion that many have arrived at—that if the propositions now before the public fail to effect the desired improvements, there can be little hope of success. The two inventions, of all that have come under our notice at present, which appear the most likely to come into general use, are Bessemer's and Farrar's; the former where cheapness and strength are highest attainable quality, is of paramount importance. In the manufacture of steel, the first consideration has ever been to obviate the necessity for the tedious process of cementation; and the more direct means of effecting this improvement, and that which has consequently been in most cases resorted to, is the combination of such chemical substances with the crude iron, as should, by the application of heat, form an alloy whose component parts should assimilate as nearly as possible with the steel manufactured in the ordinary way.

It is obvious that, according as the chemical elements of the iron vary, different treatment would be requisite to

convert it into steel; and, theoretically, all that is needed is a minute knowledge of the character of the iron to be converted; yet, in practice, unlooked-for difficulties have presented themselves, and baffled the skill of the inventors of many processes which have promised the most favorable results; and expenses have been found to be incurred from causes apparently unavoidable until discoveries in what previously seemed to be a branch of trade altogether unconnected should be made. It is to these causes that may be traced the failures which attended the early efforts of Mr. Bessemer; and it is precisely through the extreme amount of circumspection exercised previous to his discovery being made public that Mr. Farrar has obtained such unequivocal success.

Before proceeding farther it may be well to state the process by which Mr. Farrar has obtained his celebrity. He mixes sal ammoniac and prussiate of potash in the melting-pot with pieces of wrought iron, and places the whole in the furnace; the effect being that while the incorporation of the sal-ammoniac with the iron gives it malleability and capability to be welded at a common forge, without the use of borax or similar salt, the prussiate of potash effects its conversion into steel. The fluxing of the iron, however, is all that is new in the invention, so that no objection can arise that the complicated nature of the process would necessitate the re-instruction of the man employed. The process may be conveniently performed in crucibles arranged in furnaces of the construction usually employed in the manufacture of cast steel from blister steel. So far, indeed, as the workman is concerned, the sole difference is, that he puts in wrought iron instead of blister steel—the addition of 1 lb. prussiate of potash and 2 lbs. of sal-ammoniac to each ton of metal melted, being almost inappreciable during the manipulation, although its effect upon the metal produced is really marvelous.

From Swedish iron costing but \$75 per ton, a better steel is obtained by Farrar's process than can be procured by the ordinary system of conversion from the far-famed L, which costs from \$170 to \$180 per ton; and at the works of the Patent Plumbago Crucible Company we have this week inspected some steel from Pontypool iron, which, when converted into sword-blades, is, in every respect, equal to the best steel used by the Government, and costing more than four times as much.—*London Mining Journal.*

CASE-HARDENING IRON.—A good paste for case-hardening iron can be made of yellow prussiate of potash and starch, in equal proportions. Spread it over the iron thick, as a paste, and when it has been allowed to become dry, then heat it to a red heat, and afterwards plunge it into a tub of cold water.

STEEL swells in hardening. Iron absorbs carbon, and swells in case-hardening, as well as in conversion into steel. Forgings of scrap-iron are liable, in case-hardening, to absorb carbon unequally, and to twist or warp, owing to the irregularities of the iron.

CAST-STEEL, when hardened to too great an extent, has been known to explode violently. A case was reported in the *Franklin Institute Journal*, 1844, when a hardened steel step or bushing, 1½ inch in diameter, and having a ¼ inch hole, exploded with a report like that of a pistol.



## Paint Room.

For the New York Coach-maker's Magazine.

### GOSSIP FOR THE PAINT SHOP.

(Continued from page 192.)

For a carriage-painter to give his experience of varnish and varnishing, would be very tedious and wearisome to the reader; therefore I shall spare both the reader and the printer, and only make a few common-place observations,—first, upon the quality of American varnishes. I do not wish the reader, by any means, to infer that I think that good varnish cannot be made in this country. Far from it; but, both the painter, the carriage-builder, and the varnish-maker will bear me out when I state, that four-fifths of our American manufactured varnishes are very inferior articles. This is well known to all men any way interested in using varnish; and this is attributable to several causes. One cause, I consider, is, that consumers of varnish will not pay the price which makers would have to charge did they use the best of material in its manufacture. The varnish-maker might give a far better article for the price he charges than what he does, did he not want a large per cent. profit, so as to make a fortune quicker than what a legitimate and honest trade will allow him.

A great majority of our varnish-makers have not that proficiency, experience, and skill in the art, which it requires to follow it successfully. But above all, there is a *something* which no one can explain, which prevents the very same men that have manufactured the best English varnish in England from making it here in America, although they have had the same kind of stock used in England. Some lay the fault to the climate; some say there must be a difference in the stock; others lay it to not having the implements and utensils so properly constructed and adapted for the business, as in the old country; and which the trade, to carry on successfully, requires. You cannot buy varnish for undercoating in England for a much less sum than sixteen shillings (four dollars) per gallon; and for good finishing, you must pay from twenty to twenty-eight shillings per gallon.

It is most erroneous to imagine, that because varnish is made in England it must therefore be good. The English carriage-builder has pretty nearly as much trouble in getting good painting-stock, as the American coach-maker. The only sure way for him to obtain a satisfactory article is, to have it direct from the manufactory of some old-established firm (similar to the one that supplies the greater part of the American market with English varnish), whose reputation is a guaranty of its quality, for it seldom varies, and the English manufacturer but rarely exports an inferior varnish, because he knows there is always a plenty of it in the market, and his, if poor, would stand but a small chance of being sold. It is almost needless to say that varnish-making, in England, is a distinct trade or profession, and that an English coach-painter would as soon think of manufacturing cobwebs as attempt to make varnish. It is far different with our genuine native American carriage-painter. A great many, if not a majority of them, have the presumption to think that *they* can make varnish; and having a slight insight of the theory, they endeavor to put it in practice, and—as is well known—while a few may make out to make varnish

that can be used, a great majority utterly fail in the attempt.

This want of sufficient knowledge is the main cause why the quality of varnish made by the same man varies so much. Carriage-builders know by experience, that if they get one good barrel of varnish, they can never make sure of having another like it, even from our greatest establishments; and should you send it back because it sets too quick, and will not dry hard, they are sure to send you back something similar, or quite the reverse—some that will not dry at all. I have never yet seen the American varnish-maker that did not *attempt* to make a varnish that was always equal, and in a majority of cases superior, to the English varnish, and I have yet to see the man that has not utterly failed. Several of these varnishes I have tested myself; and, notwithstanding the positive assurance of its makers, together with their glaring labels, in some cases declaring it to be “one of the greatest discoveries of the age,” they have all proved failures when brought in comparison with English varnish. Some of them we might term good for undercoating, but none will stand the test of durability.

Like all other painters, I have used all kinds of varnish; some that would dry, and others that would not dry; some that would go in lumps, others that would stop in holes; some that would flow tolerably well, others that would stop upon the panels, as the brush left it, in ridges similar to a fresh-plowed field—so bad that flies and spiders could play “boo-peep” at each other upon it. Others would be so dark as to ruin every thing it was used upon; but seldom have I had to complain about its being of too light a color. Other varnishes I have used that would be so dry and hard in three days that you could take your knife and scrape it, and it would fly like so much half-melted resin; and, to the contrary, some would be soft and sweaty for three weeks. This has been so much so that you might pick it out with your finger-nail, similar to so much half-melted gum, having either too much oil in it, or else not enough.

A majority of our common varnish is so thick that it always requires thinning or warming before being used; but I have used varnish made by a would-be-varnish-maker, that was so thin that it had to be laid in the sun to warm and thicken. I know varnish-makers will say that the inexperienced workman always lays the fault to the stock. I grant it is so in some instances, but an employer with but a small amount of penetration, can soon judge where the trouble lies. You will rarely hear the same complaints against a good article, where a good price is paid for it. The qualities of varnishes are so various, the best of workmen cannot guard against some kinds of varnish “running,” while, as regards others, you could not lay on an uneven coat, even if you should desire to do so.

It is generally conceded that “two heads are better than one,” and however smart a man may be in his own estimation, when he comes to be reviewed, and his words or actions examined by others, though they may be far his inferiors, some error or discrepancy may be touched upon, which will not only help to set him right, but may help to keep others from going wrong; and there may have been some principles laid down in the articles written for the Paint-Room columns of this Magazine, which may have more meaning than my uneducated mind can comprehend; still, as they vary a little from what I have

been accustomed to practice, a little Gossip upon some of the views advanced may not be unprofitable to the general reader; and though both may be wrong, it may be the means of inducing some one to follow us who may be able to set us right. I will, therefore, refer to such of the communications which, although the process they recommend may be good, I cannot fully indorse. As I remarked in the beginning of these papers, I do so with all due respect to the opinions of the writers, merely giving my own individual opinions; and whatever I put forth, if wrong, or liable to be construed in a different light than what I intend it to be, any one who will see fit to set me right will be duly acknowledged as not only doing me a favor, but all those who take an interest in what is printed for the Painting Department of this Magazine.

In the July number of the first volume, at page 30, we have some excellent instructions how to paint a buggy carriage, and an average workman ought, by following them, to turn out a creditable job. Our friend directs, after rubbing the second coat of lead "very close," to putty up the job. I think it would be an improvement to putty on the third coat; for, after it is rubbed very close, you are liable to spread your putty upon bare wood, which would give it a chance, at some future day, to "jump off." By puttying it up on the third coat, you are sure of having plenty of lead for your putty to adhere to. In section 4, we are told to give the fourth coat of lead; "one part lamp-black and two parts white lead, either in weight or bulk,—I think it would be a little overdone with black; and if wanted in a hurry, prepare with "two parts Japan and one part oil," but if not in a hurry, "one part oil and two parts Japan." Which would be the best way to put a job through the quickest in, is a problem the editor of this Magazine may safely offer a valuable prize for solving. If the last coat of lead was prepared with two parts Japan and one part turpentine, I think a better surface might be obtained.

Section 5 instructs us to "mix the preparation coat in boiled oil and Japan," and Section 6 says, "Mix the final coat of color with raw oil and sugar of lead, using enough oil to make it shine," adding that "This *oily gloss* is a strong guaranty that the succeeding coats will not strike in." "What is good for the goose is good for the gander." If it is good to prepare the "final coat" with raw oil and sugar of lead, why not for the "preparation coat?" The only difference is, that by using *boiled* oil and Japan the workman escapes about three minutes' labor, and for sake of that little trouble he uses a worse material, and his color does not work near so free and pleasant, and he cannot lay so even a coat; and to overdo it with oil for the sake of making it shine, to prevent the following coats from striking in, when it is calculated to give two coats of color and varnish and one final coat of varnish, is, I think, a little too absurd. Surely, one coat of color and varnish is a sufficient guaranty that the remaining two will not strike in. There may be painters, as our friend remarks, that mix their colors with "one part varnish and three parts Japan," but depend upon it, they don't lay it with camel-hair blenders, especially if a carriage has had a preparation and final coat of color. One coat of color and varnish ought to make a very good job.

I agree with other writers, that, as a general rule, color and varnish mixed together proves more injurious than beneficial, and should be avoided as much as possible. One coat, if allowed to get well dry, may be used,

at times, to advantage; but in no case should one coat be put upon another, no matter whether you have color and varnish, or clear varnish. When you do rub it, it should be with a good woolen cloth. Our friend says they should be "rubbed down with a rag and ground pumice-stone," leaving the painter to infer that any offal piece of cotton cloth would answer the purpose; but the better and the more "nap" there is upon your cloth, the better satisfaction your rubbing will give you, and whenever you see a man "mossing" varnish, you can make sure he has considerable ingenuity at "skulking" work.

It is generally supposed that great heat causes varnish to blister; but our friend, in section 9, cautions us to "try and select a clear and dry day (for the last coat), as by so doing you may escape the trouble and expense of another coat thereafter, on account of its blistering," leading the reader to the inference that a cold and damp day might subject the varnish to blistering. This is certainly a mistake. Even the hottest rays the sun pours down are not sufficient to blister work well painted. To lay quick-drying color upon another coat of quick-drying color, subjects work to blistering, because the ingredients are not adhesive enough to thoroughly adhere to each other. The same applies, and frequently happens, to varnish when two coats are given from different manufactories. The last will often blister from the first, as though the last coat had been nothing more than gum shellac. Both may be good varnish, but the fault lies with the ingredients, in not being compatible with each other. It acts in the same way when applying quick-drying color to bare wood. It takes but little heat to blister it, because the paint has nothing to adhere to. If a good job is not obtained by following these instructions, it will not be because sufficient material is not given, when the surface of carriage-parts is made upon lead. I think if a painter cannot make a good job with one coat of clear color, or color and varnish, and one finishing-coat, he is not capable of improving it with a third.

(To be continued.)

#### A NEW CHROME YELLOW.

UNDER the above name a yellow color has been for some time in commerce, which is quite certain to find much favor, although its price is far higher than that of the ordinary chrome yellow. It is of a splendid yellow, and differs essentially in its tint from the best samples of chrome yellow. It is pulverulent, of small specific gravity, loses nothing in weight at a red heat, but becomes temporarily reddish brown, and is partially taken up by water without entirely dissolving in that fluid. It dissolves in muriatic and nitric acids; if the acid is poured over it in a concentrated state, a slight effervescence takes place. When prepared with but little acid the solution is somewhat turbid, but does not leave any considerable portion when filtered. When heated with alcohol, the solution in muriatic acid becomes intensely dark green; if more alcohol and then sulphuric acid be added, a white precipitate is produced. Solution of sulphate of lime does not precipitate the solution of the color in muriatic acid, but this is done by sulphuric acid with or without the addition of alcohol. The reddish-yellow color of the solution in nitric acid changes by heating, with the addition of alcohol, into a beautiful blue. If acetate of lead be added to the dilute solution in nitric acid, a heavy pre-

precipitate of the color of chromate of lead makes its appearance. If an excess of lead were added, filtered, the excess of lead and the lime precipitated by sulphuric acid, alcohol added, filtered and evaporated, large quantities gave a residue, which, when dissolved in water and mixed with chloride of platinum with the addition of muriatic acid, furnished octahedra of platino-chloride of potassium. The investigation gave no magnesia, or other bases except lime and potash. Of acids, besides the chromic acid, which was undoubtedly present from the preceding experiments, there was only a small quantity of sulphuric acid.

When the author mixed a hot saturated solution of bi-chromate of potash with a saturated solution of chloride of calcium, a precipitate was produced, which, when washed and dried, was undistinguishable from the Steinhühl yellow.

The substance gave 3.1 per cent. to distilled water after short stirring. With nitrate of silver, the yellow filtrate gave a red precipitate of chromate of silver, which was rapidly converted into white chloride of silver on the addition of a few drops of muriatic acid. Sulphuric acid and alcohol produce a strong turbidity in the filtrate. When boiled with reducing organic matters and muriatic acid, the yellow filtrate loses its color, without, however, acquiring more than a tinge of green. Acetate of lead precipitates the yellow filtrate with the color of chromate of lead. Chloride of platinum produces a very slight turbidity in the original filtrate. Even in sixteen hours no precipitate is deposited. This yellow consists, therefore, of chromic acid, lime and potash; when stirred for a short time with cold water, it parts with chromate of lime.

The poisonous qualities of chromic acid and its soluble salts, and the circumstance that the color parts with perceptible, although not large, quantities of chromic acid to cold water, render this yellow an extremely dangerous coloring matter, the employment of which, in confectionery and similar trades, must not be thought of.—*London Chemical Gazette.*

## Trimming Room.

For the New York Coach-maker's Magazine.

### PATTERN FOR A SEAT FALL.

MR. EDITOR:—*Dear Sir,* Inclosed you will find a pattern for a seat-fall. It is cut out in the form of a half circle, the hollowed side of which should be the length of the seat. The border on the lower edge is creased and stitched according to the fancy of the workman. When made and fastened to the seat, the folds lie in rolls at the bottom, tapering off at the top. This is one of my own getting up, and is entirely original. Hoping this will answer your purpose, I am,

Yours, respectfully,

R. J. BECK.

SPRINGFIELD, O., Feb. 8, 1860.

## DESIGN FOR CARRIAGE TRIMMING.

THE annexed illustration represents a very neat and appropriate design for the linings and cushions of bretts, coaches, &c. The material used may be cotline or brocatelle as preferred. The backs are filled pipe-fashion, as

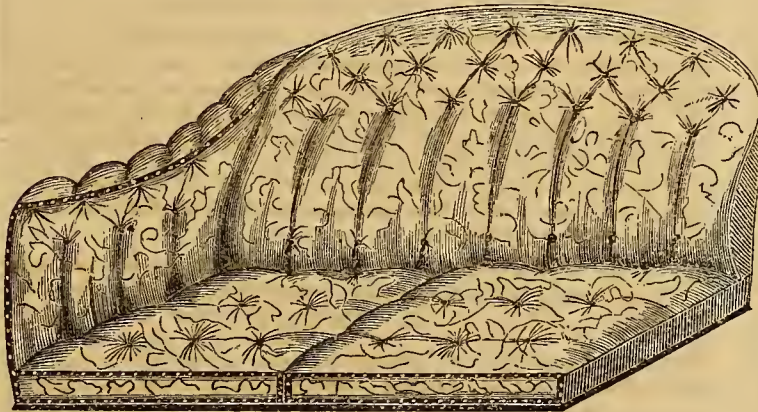

seen in the drawing, after being laid off and sewed to the buckram foundation, which must be arranged after the proper form, in the manner of that at page 173 of this volume. The whole design makes a very tasty lining for the finer kind of carriages, which cannot but be acceptable to our readers.

## EXPLANATION OF STITCHING PLATE H.

*Drawn from the Designs of various Correspondents.*

Nos. 1, 2, and 5, are corner-figures for buggy-boots.

Nos. 3, 4, and 6, are designed for the figures of dash-corners, and will also answer for boot-corners.

No. 7 is intended for the back-valance, fronts of cushions, and the edges of tops, where take-off curtains are used.

Nos. 8 and 9 are very fine designs for the center-figures of buggy-boots, dash-flaps, or seat-falls; both being in half-figures.

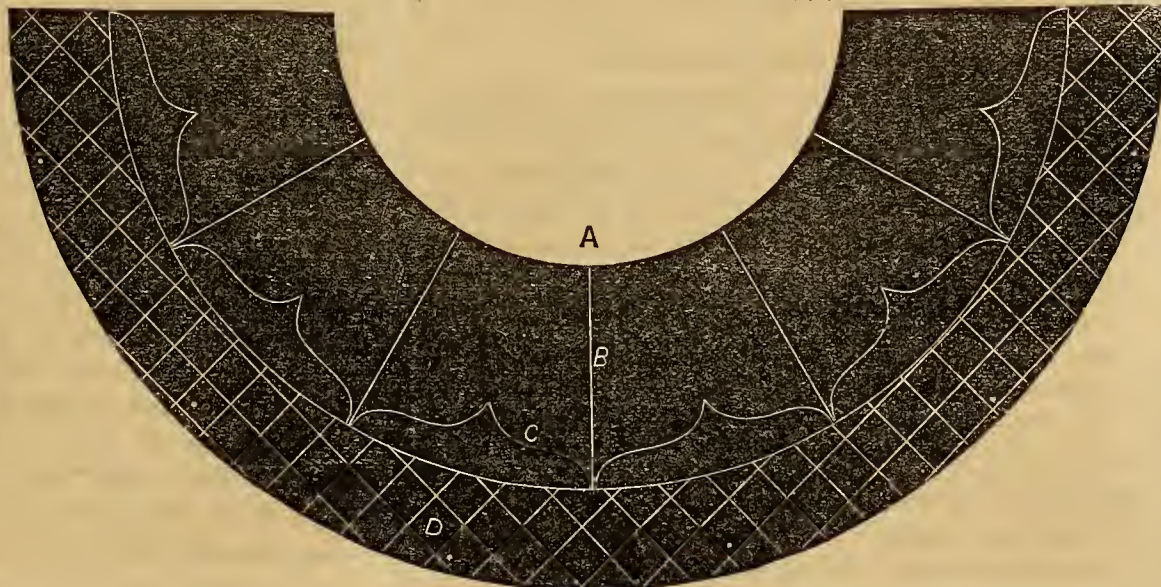

## The New York Coach-Maker's Magazine.

APRIL 2, 1860.

E. M. STRATTON, Editor.

### TO READERS AND CORRESPONDENTS.

**RENEW YOUR SUBSCRIPTIONS.**—Our present subscribers will please bear in mind that our rule is to stop the Magazine when the year expires, unless they renew by sending us the payment IN ADVANCE. To secure a complete series, therefore, our friends will see the necessity of being prompt, for we intend to regulate our edition of the THIRD VOLUME as near the wants of the craft as is possible. Southern, Western, and Canadian money, or post-office stamps, will be received at par. Subscribers in the British Provinces must remit twenty-five cents extra, to prepay postage for the year.

**CAUTION.**—The great popularity of this Magazine, has led some unprincipled individuals to speculate in obtaining subscriptions without authority. The Publisher therefore gives notice that no receipt will be considered binding unless it has attached to it an engraved facsimile of his autograph. In all cases, see that agents have a good supply of the Mag., and can produce a certificate of their honesty, entirely in the publisher's handwriting. Our friends will confer a favor if they will give us early notice of suspected impostors.

☞ All letters directed to this office on business, NOT relating to the Magazine, but solely for the writer's benefit, must inclose a stamp; if requiring an answer, two red stamps. Orders for a specimen number must be accompanied with nine three-cent stamps. When these terms are NOT complied with, no attention will be given them.

☞ Name-plates furnished to order, of different patterns, for from \$14 to \$20 per hundred, at this office, or sent according to directions, by express, payable on delivery; to which express charges must be added.

H. B. W., OF CONN.—We do not require any agent in your city at present.

L. S. B., &c.—You will see that your favor is given in the present number. We shall be happy to hear from you in the same way often.

J. G. S. OF N. Y.—You will find a track sulkey on Plate 29, Vol. I., of this Magazine. To duplicate without presenting some new feature, would prove futile.

J. H. OF R. I.—The \$5 for two volumes in numbers refers only to new subscriptions, not to such as subscribed in June last to the second volume separately.

M. O. D. OF C. W.—Sending letters to your "old friend," at Columbus, O., for an answer in relation to your \$3, would be equal to "calling spirits from the vasty deep"—they wouldn't come. Try the Colonel, at his Pine Island Farm, Galveston, Texas; perhaps they *might* come—doubtful, however.

### HONESTY AND BUSINESS.

Not unfrequently we hear some discouraged mechanic exclaiming, "No man can get along in this crafty age and pay his honest debts." Now, this is all wrong, and such as give vent to their passions and express themselves in this loose manner, do so without proper consideration. A moment's reflection will convince any person that none but those who do business "on the square" ever succeed in the long run. Let us illustrate this conclusion by examples:—

Tim Reckless is a young man who is naturally of vicious habits, and, under the teachings of dissipated and unprincipled parents, his youthful habits have ripened into confirmed crimes. At the age of sixteen he is apprenticed to the coach-making business, which he pursues

until he is twenty-one years of age, unless he runs away before that time—not an unfrequent occurrence by any means—where he labors when watched, and idles away the time when "the boss is out," apparently as careless and indifferent about the interests of his employer, or of learning his trade perfectly, as though he had no obligations of any kind to discharge. To cover up or apologize for his laziness when he is asked by the boss for a reason why his work is not done at the proper time, he resorts to the discreditable expedient of inventing some falsehood in excuse for his conduct, which generally is of so thin a texture, that any one of the least judgment can see through the badly-woven fabric. In fact, his conduct illustrates perfectly Hogarth's picture of an idle apprentice.

Having arrived at the age of twenty-one, when he is expected to set up for himself, he discovers that his inattention to learning the "art, mystery, and occupation" of carriage-making, has left him an unskillful workman, and his unprincipled habits deprived him of respectable character. Should he be successful in obtaining work as a journeyman, his first essay proves unsatisfactory, since his inexperience soon shows itself; and should the employer get rid of his new hand without having the minds of his other employees poisoned by coming in contact with him, he is very fortunate. We have known men of this stripe to put a manufacturer to great trouble in a few days, from the dissatisfaction such fellows breed in the shop the atmosphere of which has been fouled by their breath. Had this class of pests no more ingenuity in breeding dissatisfaction in a shop, than they exhibit as mechanics, their career would soon end. There are always to be found some weak enough to listen to the subtle but plausible jackanapes.

This class of men exhibit no better character as principals in business than they did as apprentices and journeymen. Their proceedings are such that everybody suspects them. They can find no one to trust them for a few dollars, which will often be found convenient in a business requiring considerable capital, like that of coach-making. Should they employ hands, their reputation only brings them incompetent workmen, such as are too unskillful to find employment where matters are conducted in a proper way. In fact, this class of business men know nothing about honesty, or if they do, disregard her wholesome teachings. The public, however, who have a keen eye to passing events, very soon will discover such flaws as are prominent in Mr. Reckless' character, and therefore stand aloof. False representations made in order to "sell," and promises of promptness never redeemed, soon prove, even to the dishonest man (it may be when too late), that "honesty is the best policy, carried out in all affairs of life.

Let us now look at the other side of our picture.

James Careful stands in striking contrast with Tim Reckless. With him truth, honor, and punctuality are constitutional laws, and to these everything must conform. His word passes for as great value as his neighbor's bond. When he promises to do a certain act on a certain day, you *feel* that it will be done without fail. His word and honor are at all times equal to a *good* check on the bank, for all business purposes. When he sells you an article, it will always prove to be the same as represented, or else afterwards *made* as good. Your confidence in him will never be misplaced, for there is no circumlocution in his way of conducting business. He never tells a customer that his carriage will be ready on a certain day, when he knows at the same time it will be impossible to redeem his promise, merely for the sake of getting a job. He will candidly and frankly tell you just how he is situated, and just when your job will be ready, and in most instances the customer will get his work from Careful, although promised three weeks later, sooner than he will from Reckless, promised earlier.

Your perfectly honest man will not engage heedlessly in business, but goes to work with a small capital, trusting that his experience will increase with it. He is unwilling to launch out into business with a borrowed capital before he is sure of success. With industry, prudence, and economy, the James Carefuls are sure to succeed, while these Reckless fellows are sure to fail, and perhaps ruin other and innocent parties in their fall. We could, did propriety admit, here give names of many whom we have known, that have struggled through life in poverty because of their dishonesty. The wise man, Solomon, tells us, "that the getting of treasures by a lying tongue is a vanity tossed to and fro of them that seek death." In a word, success in life must be based upon principles strictly honest, for we can only expect to receive the sympathy of our fellow-men where they exist. Many a man of business has found in his honesty the direct road to wealth; while the reverse is sure to end in poverty and disgrace.

#### THE LAST BUT ONE.

THE second year of our Magazine will close with the number for May. With it we shall present our patrons with a handsome title-page to match that of the first volume, with a complete index to the engravings and letterpress, and an appropriate preface. Those of our subscribers who commenced their patronage in January, can have the seven previous numbers to complete the second volume for \$1 75, by mail or otherwise, from this office, should they desire it.

Our success the past year has exceeded the first, and we anticipate the third year will prove better still. Our onward, independent course has won for us numerous friends, who have not only furnished us helps in the way

of manuscript contributions, but also in that to us equally important matter, club subscriptions to the work. We find there are yet some who expect to get the work hereafter cheaper, just because *it will be older*; but we would disabuse the minds of all such, by stating that we have but a few copies of the second volume for sale, and those will be charged for: three dollars in numbers, and three dollars and fifty cents bound in muslin. In no case do we intend to reduce our prices, either for the entire work, or in parts, from those printed on the cover of this number. With these determinations from the start, we have labored to give our volumes a standard character, and hope to find in this feature of the Magazine, increasing interest the older the work becomes. We trust, therefore, that all who have flattered themselves with this vain hope, will send on our standard price and secure the most useful and beautiful work, either in their special business or any other department of the mechanical arts, to be found in this country. Of the first volume we have yet a good supply.

The temporary inconveniences to which we were put in being burned out of our former printing-office, have all been remedied, and we are now in the full tide of completeness for insuring a prompt issue of future numbers. In our next will be found a prospectus for the Third Volume, with other information suitable to be known to our numerous friends among the Coach-making fraternity. That number (the one for May, and the last of the second year's issue) will be published about the fifteenth of April. All subscriptions which began in June, 1859, will then close (see under editorial head), but we trust will be renewed by a new remittance in time to have the June number, which will be No. 1, Vol. III., and ready by the first of May. We have made arrangements for canvassing for the work, but we hope none will wait for our agent to visit them, as from the circuit of country he will have to travel, he may not reach your place until late in the fall, or winter.

The promises we have for help in the third volume, in addition to matter already received, we think will warrant us in promising a more useful, as well as a deeply interesting work. In the trimming department especially, we hope to satisfy our readers. With this end in view, we have made suitable arrangements. And now, to conclude: Instead of the *blowing*, coarse-looking volume furnished the public by "The Pioneer," of *only* 131 pages of reading matter, our friends have 236, and mostly original, written expressly for the work; instead of 25, ours have 47, including the 4 stitching plates, and with engravings as far exceeding the Ohio work in fineness, as the sun does the moon in splendor. When all these things are taken into consideration, we may consistently exclaim, after comparison, with it—*Excelsior!*

## TRADE STRIKES AND THE CONSEQUENCES.

ANY one who has observed the effects of mechanical strikes with any degree of attention, in this country, will join with us in saying that the following remarks from the *London Quarterly Review*, are both able and sensible, and recommend themselves to the consideration of every intelligent and well-disposed mind.

If strikes and combinations could elevate the condition of labor, Dublin must now have been the paradise of working men. The operatives there, with true Celtic vehemence, have thrown themselves heart and soul into the Unions, and have fought their battles with a devotion worthy of a better cause. Moreover, they have been almost uniformly successful; but their victories have been even more disastrous than defeats. Dublin was formerly the seat of numerous extensive and highly prosperous manufactures and trades. One after another these various branches of industry were ruined by strikes. Flannel, silk, lace, gloves, almost ceased to be manufactured, and the best Irish workmen migrated to England and Scotland. The wretched and poverty-stricken 'Liberties' of Dublin—untroubled by machinery and capital, but infested with pauperism in its most revolting forms—still testify to the ruin inflicted on the trade of Ireland by the combinations of her operatives. O'Connell himself admitted that Trades' Unions had wrought more evil to Ireland than even absenteeism and Saxon mal-administration. The monopoly and restrictions enforced by the Dublin unionists were most rigid; but, as usual, their heaviest pressure was upon the working people outside of their combinations, who were sacrificed without mercy. Unskilled labor was paid as low as 6d. a day, in the very shops in which the unionists were striving to keep up their own wages at an unnatural rate. They prescribed a minimum rate of wages for themselves, so that the worst workmen should receive the same as the best. They left little or no choice to the employers in the selection of their men; and the master in want of an additional hand had to go to the Trades' Union and take the person who stood first on their register. 'Knob-sticks,' or non-unionists, were rigidly excluded; and if any unprivileged man ventured to work at any union, it was at the peril of his life. Indeed, several poor wretches were assassinated at the expense of the Unions, and the murderers remained undiscovered. No organization could have been more perfect; and its result was ruin. The shipwrights and sawyers carried every point with their masters; and in the course of a few years there was not a single master-shipwright in Dublin. If vessels frequenting the port required repairs, they were merely cobbled up so as to insure their safety across the channel to Belfast or Liverpool. The Dublin iron manufacture was destroyed in the same way. Mr. Robinson, an iron-master, was prohibited by his men from using a machine which he had invented to meet the competition of English-made nails; and the trade in consequence left Dublin, never to return. Another manufacturer, anxious to execute some metal works in Dublin, in order that Irish industry might have the benefit, found to his dismay that he was precluded from competing with England, not by any local disadvantages, or want of coal or iron, but solely by the regulations enforced by his own workmen. It was thus that the iron trade went down. O'Connell estimated that at least half a million a year had been lost

to the Irish capital in wages alone, through the combinations of the Unions. Almost the only branch of trade in Dublin against which strikes failed has been that of coach-building; and it has accordingly been preserved. The Messrs Hutton held their ground with heroic perseverance. The unionists battered their carriages, cut the silk and laces, beat their foremen, and compelled the masters to ride home armed and guarded; nevertheless, they persisted in carrying on their business in their own way, and by this means kept up their splendid coach manufacture, which would doubtless otherwise have been driven out of the island. The strike infatuation ruined the trade of other districts in Ireland. An Irish capitalist erected a costly manufactory at Bandon, and succeeded in obtaining a large contract. He bought machinery; the workmen worked till it had been erected, and then struck for increased pay. 'We know,' they said, 'that you have got a contract in Spain and Portugal; and you must, therefore, give us higher wages.' The proprietor gave the increase demanded, worked out his contract, and then abandoned the manufactory. The consequence was a loss to the Bandon work-people in wages of about £12,000 a year. Dr. Doyle stated before the Irish Committee of 1830, that the almost total extinction of the blanket trade of Kilkenny was attributed to the combinations of the weavers. No sooner was it known that any manufacturer had taken a contract, than the weavers immediately insisted on an advance. The consequence was that manufacturers would not enter into contracts; they withdrew their capital, the blanket trade was ruined, and weavers became paupers, and had to be maintained at the public expense. Such are only a few illustrations of the triumphs of strikes in Ireland."

## FAMILIAR LETTERS FROM THE CRAFT.

[The following doggerel came to us from a "brother chip," who if not quite up to Bryant in poetry, is not far behind him in sentiment. For these reasons, we cannot refuse him a place in our columns.]

BRIDGEPORT, CONN., March 3, 1860.

FRIEND STRATTON:—A few days since I was in the wood-shop of one of our carriage-factories in a neighboring city. I saw there an old jour, engaged in packing up his kit of tools. Holding up a jack-plane he said to me, "That tool is the first I ever bought, and forty-five years we have been shopmates together, and no money could induce me to part with it." When I left him, I fancied him holding a "soliloquy" over his old plane, as follows:

Farewell, my old jack-plane!  
I say it with deep sorrow;  
Our day's work now is done,  
We'll have no work to-morrow.

How many tedious hours,  
Side and side we've stood,  
In labor at the bench!  
But now we part "for good."

Let's see: Carriage-parts at first  
Engaged us one whole year;  
Then wheels of divers sorts  
We encountered, void of fear.

At rockers getting out  
For buggies, we began;  
'Twas then, my dear jack-plane,  
They called me a young man!

You've since, my fortune followed,  
From a buggy to a coach,  
And never for a moment  
Brought upon me a reproach.

But the years have many been,  
Since acquaintance we began,  
I was then a giddy youth;  
Now an old and wiser man.

My limbs have palsied grown;  
My enjoyments now are o'er;  
And thus, my old jack-plane,  
I need thee here no more!

The last body now is finished,—  
The last shaving you have made,—  
The last day with us is ended,  
That we labor at our trade.

L.

BOSTON, MASS., March 6th, 1860.

MR. EDITOR:—The Magazine for March comes promptly to hand, and I congratulate you upon the energy and perseverance you have displayed in so soon recovering from your late misfortune. Surely, this instance ought to be convincing to all who are any ways skeptical as to the Magazine proving a failure. Your promptness in replenishing your stock destroyed, and the evident improvement in the general appearance of this number, conclusively shows that the work is in right hands, and that it is certain of success.

It would have been some little disappointment to me, had not my communication upon "Carriage-work in Boston, Mass.," been noticed by some one of your numerous correspondents. I never expected that any writer hailing from this city—the famous stronghold of those "plaguey Yankees," would be allowed to have "his say" all his own way, upon the construction of carriage-work; for the very reason that no workmen are allowed to know anything about it except those who have had their training or spent some time in a few shops well known to the trade throughout the country; and this may be perfectly true, but it is hard to convince a majority of the workmen of this city of the fact.

They claim no particular superiority as mechanics over workmen in other cities; but they are ready to maintain that their work is made with more regard to its durability and usefulness, than a majority of work manufactured in other parts of this country.

It is with pleasure, then, I reply to "A Friend of Logic," feeling assured that a little harmless discussion carried on with respectful courtesy by men who will willingly substantiate or cheerfully retract whatever they may advance in support of their individual opinions, and never allowing it to assume a sectional character. It may be interesting and even instructive to those readers located far away from the Eastern States. It was for this reason I held out some inducements, and rather invited a little discussion, upon the manufacture of Eastern carriage-work.

Let us examine the language I used, and to which my critic takes exceptions. "No sensible man would dare to charge them (*i. e.* Western workmen) with incompetence or inexperience, for *perhaps* there are no better workmen found than those employed in large manufactories." I grant it; I maintain it to be a fact; let my friend (presuming he will allow me the expression) examine the

character of the help employed in a factory where nothing but custom and jobbing work is done, and he will find there is one competent man employed, who is at the head of each branch, and the remainder but indifferent workmen; but not so in a factory "where work is made for the market." The bosses build a certain class of work; the help are perfectly acquainted with the work they are to build; they know the price they will receive; past experience has demonstrated the exact time it will occupy them, and the workman feels a self-confidence of earning a satisfactory remuneration for his labor.

I will undertake to assert that no Boston workman will charge our Western fellow-craftsmen with "incompetence or inexperience" *at their own particular style of work*. I know no workmen in this city who would undertake to do the same *quantity* of work in the same time that Western workmen say (and I know it to be a fact) they do it in. When your body-makers deign to come among us "*provincials*" and say to us, "I make dat big coach-body in five veek tree days—you make him so soon?" we answer "No! couldn't begin to do it." When your trimmers tell us, "When trade is good and work wanted we can trim a coach each week," we look surprised, and ejaculate, "Is it possible?" When your blacksmiths tell us, "We reckoned to book a job (coach) each week," we appear astonished as we eagerly answer, "Want know—do tell!" When your painters tell us of the almost incredibly short time they take to paint a coach, we acknowledge it, and give them credit for its outside appearance. When we are told that you put the best of wheels upon your work, and they cost but fifteen dollars a set, while our "old foggy" bosses pay sixteen, eighteen, and twenty-four dollars a set for making them—when you tell us all these wondrous tales of your smartness, we feel a little overcome, but revive and conclude there must be two sides to the question.

For the information of "A Friend of Logic," I will state that the art of coach-building is divided into five distinct branches, *viz.*, body-making, carriage-building, blacksmithing, painting, and wheel-making, each branch being a distinct trade of itself. The subdividing they undergo does not affect their individuality. The trimmer is expected to be competent to do all the cloth and leather work—the one part as perfect as the other; body-makers to build coaches, buggies, or chaises; blacksmiths to do *all* the iron work; painters to work upon the bodies or carriages, with the ability to finish each. How many Western workmen are capable of doing this—of carrying a piece of work through its separate branches entire? Trimmers who only know their trade as the making up of the cloth part, and putting it in the body, are only half trimmers; and when we are told it only costs twenty-five dollars to trim a coach, we conclude the writer intends *half-trimming* it—only the cloth part of it. At this class of work we readily admit they have no equals; but "if they were to come to Boston," these men that perhaps never made a dickey-seat in their lifetime, "they would find it *difficult* to do the work"—to trim a first-class coach, and finish it in the style Boston work is finished in. We maintain "they would find it *difficult* to do the work at all," and "if they could do it" *in the same time and style of workmanship*—*putting them upon an equality with Boston workmen*, "they would soon find out that though having one-third more money for the same kind of vehicle, they could not earn as much by *two*, three, or four dollars

per week" perfectly right. Our trimmers cannot earn so much per week as Western trimmers say, and which I know they *have* done, the difference in the workmanship being more than the difference in the price.

With regard to the price paid for trimming a "Western Coach;" our friend puts it down at twenty-five dollars. Was there no friend nigh who could have corrected and told him of his mistake? who could have told him that "*trimming*," in the ordinary acceptance of the word, includes all the leather work. As our friend appears ignorant of what constitutes the trimming department I would advise him to study the subject a little.

Western employers pay from twenty-five to twenty-eight dollars for the lining of a coach. We will say twenty-five for a plain-furnished coach without *extras*. Now, let our friend inquire for the sum they pay for dickey-seat and cushions, footman-holders, squabs, the extra pay for French cushions, for trimming extra windows, for cover for dickey-seat, for driver's-boot, and without doubt a great many more *extras*, all of which comes into the Boston trimmers' work, and let our friend add all these to the twenty-five, and he will find that the sum total will amount to about *forty dollars*. Without feeling justified in giving the exact amount of dollars and cents our trimmers receive for the same quantity of work, I may say that *forty dollars* is not *two-thirds* by a "considerable" sum of the amount they receive now—and have done for twenty years past—for trimming a Boston coach, exclusive of from some four to six dollars the employers pay for women's work.

I am willing to leave it to "A Friend of Logic" whether thirteen days (one hundred and thirty hours), would be the average time a Western trimmer would occupy in finishing a Western coach. We may safely conclude it to be the shortest time they would take, and allowing the Boston trimmer the same privilege, we find twenty-four days (two hundred and forty hours), to be the quickest time they could trim a similar piece of work in, "Boston fashion." This would give to the Western workman about three dollars and eight cents a day, and, to the Boston workmen, two dollars and fifty cents a day, thus fully substantiating the expression I made use of—"they could not earn as much by two, three, or four dollars per week," as they *say* they do at "work made for the market."

Presuming, then, that twenty-four days is the shortest time in which a coach body could be properly and *faithfully* trimmed, and giving the Boston workmen the credit of being able to execute the same *quantity* and *quality* of work in as short time as any other mechanic living, we establish the fact that if Western trimming was faithfully executed, it would occupy the same time that Boston workmen take to do it, which would give to the Western trimmer *about one dollar and sixty cents* a day, showing a balance of eighty-four cents a day in favor of the Boston workmen. Add to this sum the amount they do actually receive, and we have the proof that Boston workmen do earn a *comfortable livelihood*, while the pay of our Western friends would allow nothing more than a bare subsistence, in my opinion fully substantiating the words I made use of, "when work is made for the market they have to be smart and nothing but smart (i.e., *at slighting the work*), to earn a comfortable livelihood, the prices being so cut down as to preclude the possibility of their doing more than that."

A majority of the above remarks are applicable to the blacksmith's work. We have specimens of Western blacksmiths among us who have the name of being "tip top workmen;" but when we see men turn out axletree-clips that only touch the spring at the extreme point—the sides being a full quarter of an inch less than the depth of the axle-tree—the clips around the springs a quarter of an inch wider than the springs; the sweep-wheel binding upon one side and open at the other; the "stays" burnt into the bed until there is scarcely any wood left; the bed-plates projecting out in one place and lacking breadth in another; the futchels hammered out of place to accommodate the iron work; the whole carriage-part out of square by some inches; the whole iron work but scratched over; the body burnt; rockers split; feloes pounded into holes; the tires not half welded and merely dropped around the wheel; when we have Western workmen come among us and do such work, and insist upon its being the best of work, equal and better than other men's work who take the necessary time and who finish their work so that it will bear inspection and comparing with any other work you can bring forward—I say when a party of such men put their "change" together, come and build their mud-hovel, and do this kind of work for the only reason for to be enabled to undersell all other honorable builders—I say when a company of such men come among us to reduce the Boston workman's wages thirty per cent. less than it *has ever been*, and because they cannot do that import "Western workmen" to do their work, and who gladly accept the offer—when these men come among us and ridicule and call it "fogyism" of other builders whose work is a credit to themselves and the craft, why then "A Boston Journeyman" has no hesitation to tell such men that their work "is not fit to grace the woodwork of a scavenger's cart," and holds himself responsible for proof of the language.

There are exceptions in all cases; I could name a Western workman who irons a coach in from five to six days. He came to Boston, and worked some two years. One man will swear he was over ten weeks doing the iron-work to a single coach. Twenty men who worked by his side, say he was over eight weeks. His present Western employer considers him one of the best workmen in the country. His Boston employer speaks highly of him as one of the best mechanics he has ever employed. I will not pretend to be ignorant of the difference in the quantity of work that comes under the term, "ironing a coach;" but we will allow double the time to the Western workmen for the extra quantity that would come under the same term in Boston, and we find that this man took at least eight weeks to make the same amount of work in Boston that he would have made in two weeks in a Western shop, and I presume there are hundreds more such men who can either do good or bad, quick or slow work; therefore, while I give my fellow-craftsmen all due credit and fully admit—as a class—take them as a whole, "there are no better workmen to be found," I demur against their "blowing" and falsely disparaging other men's work, who get a better price and who can well afford to put a better finish to their work.

The hard-working, industrious mechanic cannot be blamed for finishing his work according to the remuneration he receives; for his strong arms and willing heart are his only working capital, and it behoves him to make as much profit out of them (or, if you please, with them) as



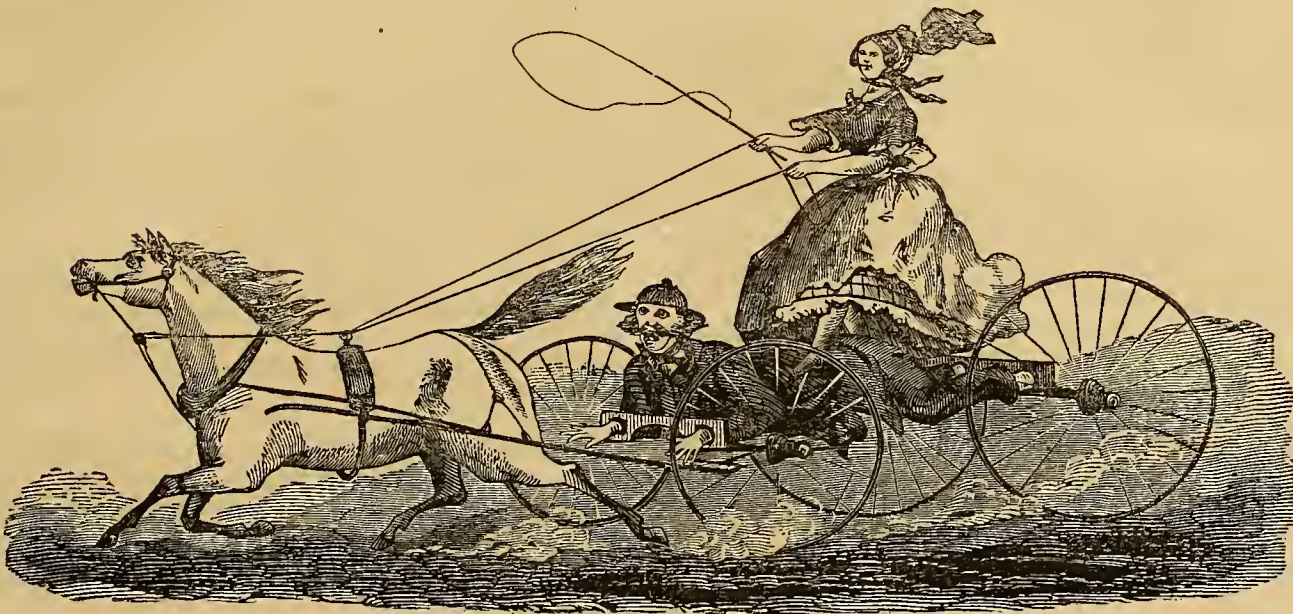

COACH-MAKING EXTRAORDINARY—THE LATEST CUT.—Mrs. Fungus, late Miss-Placed Confidence, the fast young lady whose portrait we gave on page 140, finding that riding in sulkies was hazardous amusement for persons of her sex, and having since taken a partner, “good for nothing else,” has concluded to try another experiment on the road, to the astonishment of the b’hoys; and so rigged out a new-fangled idea, and is cutting a swell by “going the whole figure.”

he honestly can. But the article upon Boston Carriage-work was merely intended to show that the public will pay a good price for good work. This has been fully demonstrated in Boston. Our builders have as much work to do as they are capable of doing, and at the prices named. These remarks are not so concise and explicit as the writer could wish them to be; but *our Magazine* is a mechanical journal, contributed to by mechanics; therefore, nothing very classical should be expected; but if these remarks do not “tally” with the “consistency” of “A Friend of Logic,” and he will say so, why so long as Worcester’s Quarto and Webster’s Unabridged hold out, why so long he may expect to hear from his fellow-craftsman,—  
A BOSTON JOURNEYMAN.

ENON, ALA., Feb. 13th, 1860.

MR. EDITOR: *Sir*—Having noticed a copy of your excellent Magazine a day or two since, I have concluded to become a subscriber to it. I believe it to be a very useful work, and well worth the price of subscription to any carriage-maker. You will please find three dollars inclosed, for which send a copy to my address, commencing with the January number.

Yours, respectfully, J. L. B.

Extract from a letter dated LINDEN, GENESSEE Co., N. Y., Jan. 26th, 1860.

MR. STRATTON:—You stated in your January number, that you would like to be informed with regard to the width of track made in different parts of the country. I would say to you, that the track in the western part of the State of New York, is four feet and seven inches from outside to outside of the fellocs.  
A. J. V.

AN OMNIBUS-DRIVER PUNISHED.—It would appear as though the drivers of omnibuses in England were a “leetle harder” than those of New York. Take the following example: One was lately brought before Mr. Jardine for rudely dragging a gentleman through the mud some yards, by way of punishment for refusing to ride in an omnibus because it was full!—Who ever heard of such a thing as an omnibus being full?—The magistrate did not, in this case, let the offender off with a simple fine, to be paid by subscription of fellow cads, but sentenced him to a fortnight’s imprisonment at hard labor. A few such lessons as this might be given in New York, with profit to the public, notwithstanding that the city-car “institution” has done something in correcting “cabby’s” rude manners.

A PACHA’S AMUSEMENT.—The British government has recently presented Said Pacha with a locomotive. On its arrival in Cairo, the Pacha ordered the engineer to get up steam, and had the half-dozen carriages of the personages attending, and his own, attached to it; then, requesting them to get into their carriages, he started off with them—the locomotive at full speed—to the dismay of the affrighted Turks. Such a thing as a locomotive being novel, the poor Arabs were frightened almost dead, to the amusement of the Pacha and his English friends there resident, as they were hurried through the streets of that ancient city.

INVENTIONS APPERTAINING TO COACH-MAKING  
AT HOME AND ABROAD.

AMERICAN PATENTED INVENTIONS.

Feb. 7. AN IMPROVEMENT IN ADJUSTABLE CARRIAGE-SPRINGS.—Ira Carter, of Champlain, N. Y.: I claim transmitting the weight of the load of a wheel vehicle to its spring, W, through the medium of an adjustable lever, J, and the lever-frames, G, G, or their equivalents, substantially as and for the purpose set forth.

AN IMPROVEMENT IN METHOD OF SHARPENING FILES, &c.—Wm. B. Gillett, of Auburn, N. Y.: I claim the application of the electro-chemical process herein described, for the purpose of re-cutting and sharpening steel rasps and files in the manner aforesaid, or any other substantially the same and which will produce the intended effect.

AN IMPROVEMENT IN ATTACHING CARRIAGE-THILLS.—Charles B. Wood, of New York city: I claim the clips, C, formed of two longitudinal parts, A, B, to admit of being securely fitted to the bead, B, and axle, A, in connection with the eye, D, attached to the thills, and arranged so as to encompass the clips, substantially as described.

AN IMPROVEMENT IN SAFETY-STRAPS FOR SECURING CARRIAGE-THILLS.—Charles B. Wood, of New York city: I claim the strap, F, formed by two parts, C, D, provided with a ring, E, and applied to the axle and thills, substantially as and for the purpose set forth.

AN IMPROVED TUYERE.—C. H. Thompson, of Orange, Mass. (assigned to himself, George Carpenter, and J. S. Emery, of same place): I claim the forked valve, E, constructed, arranged, and operating in combination with the perforated top of the air-box, substantially as set forth, and for the purposes described.

Feb. 14. AN IMPROVEMENT IN METALLIC CARRIAGE-HUBS.—Harris Boardman, of Lancaster, Pa.: I claim the arrangement and combination of the clamp plates, E, and wedge, D, as attached to the chambered metallic hub, substantially as described, and for the purpose set forth.

AN IMPROVEMENT IN CARRIAGE-THILL ATTACHMENTS.—Henry E. Clinton, of Woodbridge, Conn.: I claim the application of spring-key, B, substantially and for the purposes as is herein set forth.

AN IMPROVEMENT IN CARRIAGE-TOPS.—James M. Freeman, of Belleville, N. Y.: I claim the arm, A, with its button, D, or its equivalent, which will allow the carriage-top to be raised and lowered without buttoning and unbuttoning or injuring the curtains to the top, and allow at the same time the top to be extended forward so as more completely to protect the person from storms and inclement weather.

AN IMPROVEMENT IN MACHINES FOR BENDING TIRE.—William Mosher, Isaac H. Mosher, and John J. Harris, of Greene, N. Y.: We claim the scroll-shaped stationary former, the mode of holding the end of the bar to be bent; the manner of adjusting the friction roller by the wedge-shaped key through the lever bearing against the center bolt, all in combination as specified, and for the purposes set forth.

AN IMPROVEMENT IN LATHES FOR TURNING IRREGULAR FORMS.—Dccatur West and Aaron Puderbaugh, of Waltz Township, Ind.: We claim the combination of the vertically-reciprocating cutters, C, with the longitudinally-traveling carriage, B, and laterally sliding gage, E, by the means and in the manner substantially as described, for the purpose set forth.

AN IMPROVEMENT IN PORTABLE SLEDS.—Joseph Lamb, of New York city (assignor to himself and Richard Lamb, of same place): I claim, First, A folding sled as a new article of manufacture, the parts being hinged together and capable of being instantly expanded into a rigid sled, or folded in a small compass, as set forth.

Second, I claim in a folding sled, the described combination and arrangement of the grooved braces, B, cross-braces, C, and runners, R, whereby the sled, when folded, occupies a thickness equal only to that of the braces, B or C, themselves.

Third, I claim, in connection with the last, the described arrangement of the back-frame, A, by which it is folded into the place of the braces, B, C, and runners, R.

Fourth, I claim, in a folding sled, constructed substantially as described, the employment of the flexible or hinged foot-rest, E, so arranged and suspended as to secure the advantages set forth.

Feb. 21. RE-ISSUE.—IMPROVEMENT IN NUT MACHINES.—Patented June 3, 1856: I claim forcing a portion or the whole of the metal displaced in forming the holes in the nuts, in the bodies of the nuts; by which I am enabled to make the nuts thicker and more compact than the bar from which they are cut; all substantially as set forth.

Feb 28. IMPROVEMENT IN BOXES OF CARRIAGE WHEELS.—Wm. Sharp, of Catharine, N. Y.: I claim constructing the wheels of carriages and other vehicles, with reversed beveled bearings and boxes of corresponding form, the outer of said bearings having the greater inclination of the two, substantially as and for the purpose set forth.

RECENT EUROPEAN PATENTED INVENTIONS.

September 28. John F. Stanford, 7 Denbigh Place, Pimlico, London.—An improved apparatus for giving warmth to the lower extremities and members of invalids and others when traveling, or in churches, chapels, theaters, rooms, carriages, and other similar places, and on shipboard; and also for airing carriages.

September 30. Job Smith, 18 Warwick Court, Gray's Inn, London.—Improvements in the construction of children's carriages, called "perambulators."

August 17. Alfred V. Newton, 66 Chancery Lane, London.—Improvements in the construction of carriages, and in the apparatus for guiding or reining in carriage horses.

October 5. James Webster, Birmingham, Warwickshire.—An improved construction of spring for carriages and other purposes.

October 11. Joseph L. Tenting, Paris.—Improvements in the construction of buffers for railway and other carriages, also applicable to other purposes where springs are employed.

Joseph L. Tenting, Paris.—Improvements in the construction of the axles of railway and other carriages.

Oct. 11. John Earl, Melbourne, Derby.—Improvements in arranging and applying harness to the draft of carriages.

Oct. 15. William E. Newton, 66 Chancery Lane, London.—An improvement in the mode of applying india-rubber, gutta-percha, or other elastic substances, to give elasticity between the tires or outer rims and the hubs or naves of railway or other wheels, and between other metallic bodies.

October 19. John H. Banks, Mediaeval Works, Radnor St., Manchester.—Improvements in machinery for boring, cutting, molding, and carving wood, stone, and other materials.

George Gregg, Sheffield, Yorkshire.—An improved method of dyeing leather black.

Charles Seaton, Edinburgh.—Improvements applicable to the wheels of carriages generally, for the purpose of reducing the draught thereof.

Joseph R. Palmer, Newport Cottage, Old Ford, Bow, London.—Improvements in the manufacture of printing-ink, and paints and varnishes, and also in the manufacture of lacquers, japons, and blackings.

October 25. William A. Matthews, Sheffield, Yorkshire.—Improvements in springs.

November 5. Francis Pichler, 162 Great Portland Street, Oxford Street, and Henry J. Wigley, 5 Lancaster Place, Gloucester Gate, Regent's Park, London. The arrangements and construction of wheeled carriages or other vehicles or machines, in such manner that the occupants thereof may propel the same by alternating the weight of the person or persons riding.

November 7. George Pacey, 2 Waterloo Street and Upper Priory, Birmingham.—A rein handle and holder, applicable for riding or driving, either for single, double, or team reins.



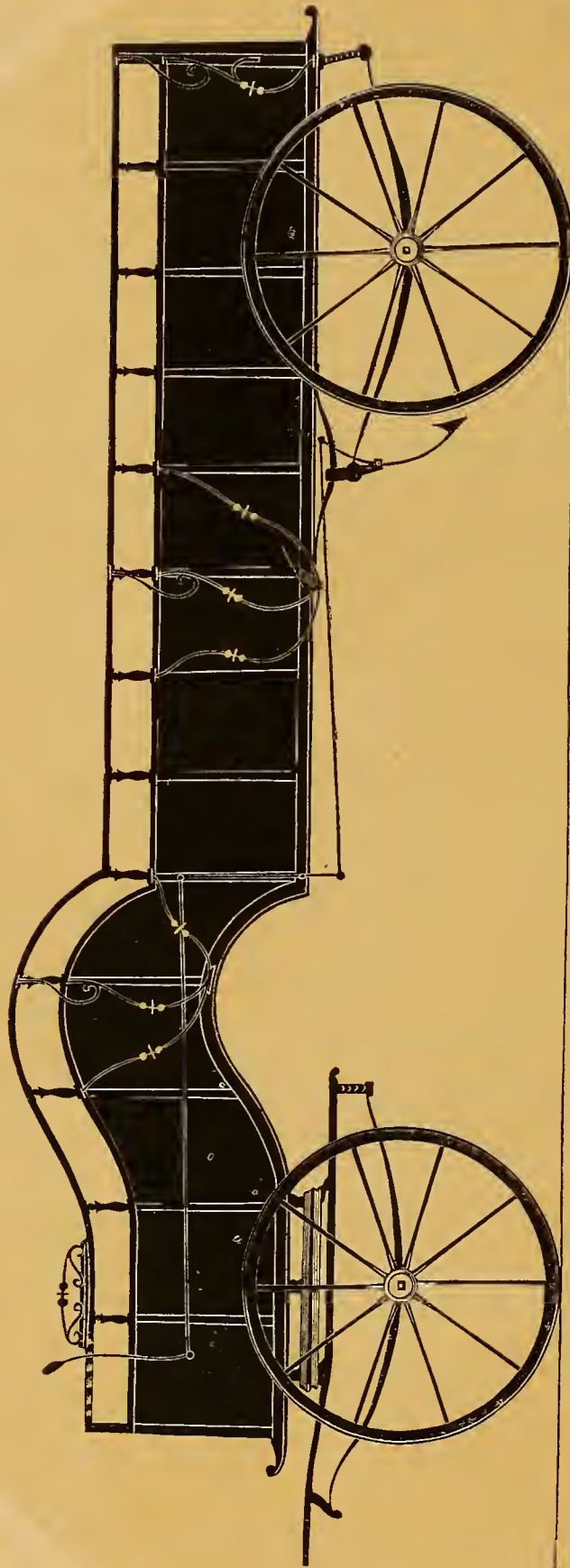

FURNITURE CAR.— $\frac{2}{3}$  SCALE.

*Engraved expressly for the New York Coach-Maker's Magazine.—Explained on page 258.*

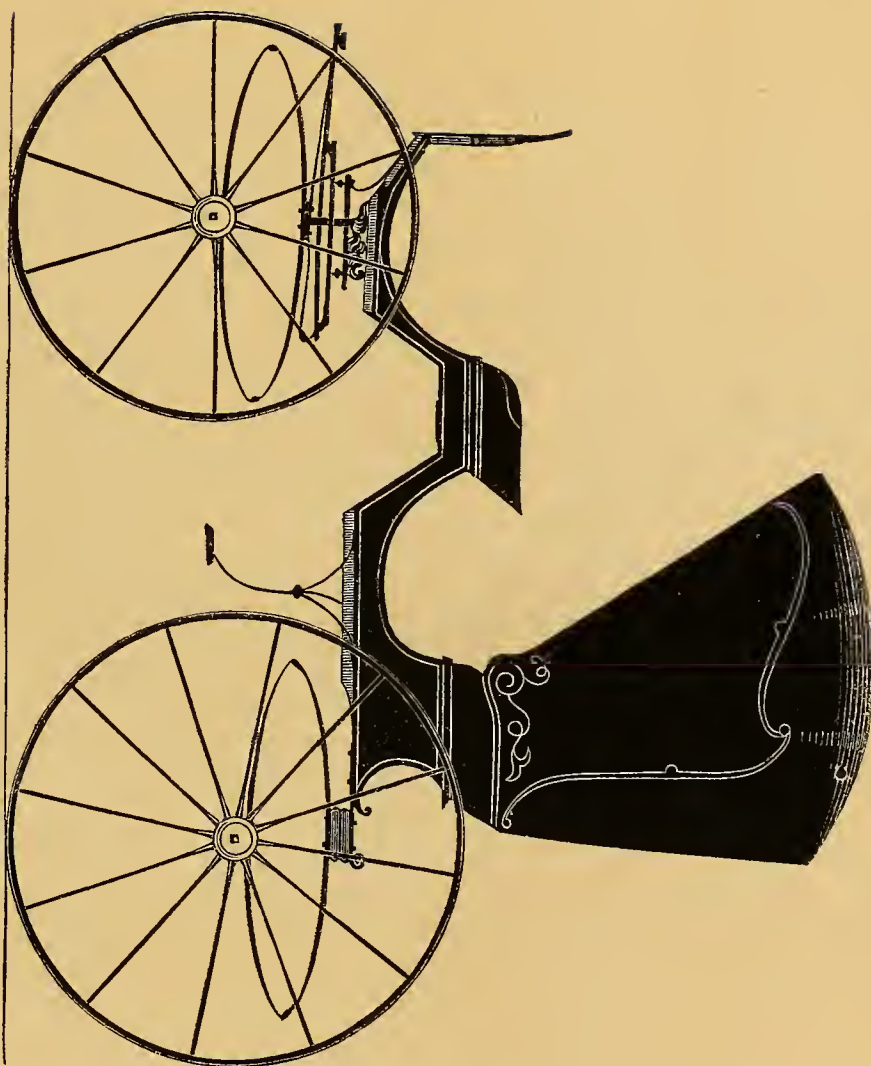

ODELL & WATERMAN'S BRETT. —  $\frac{1}{2}$  IN. SCALE.

*Engraved expressly for the New York Coach-Maker's Magazine. — Explained on page 228.*





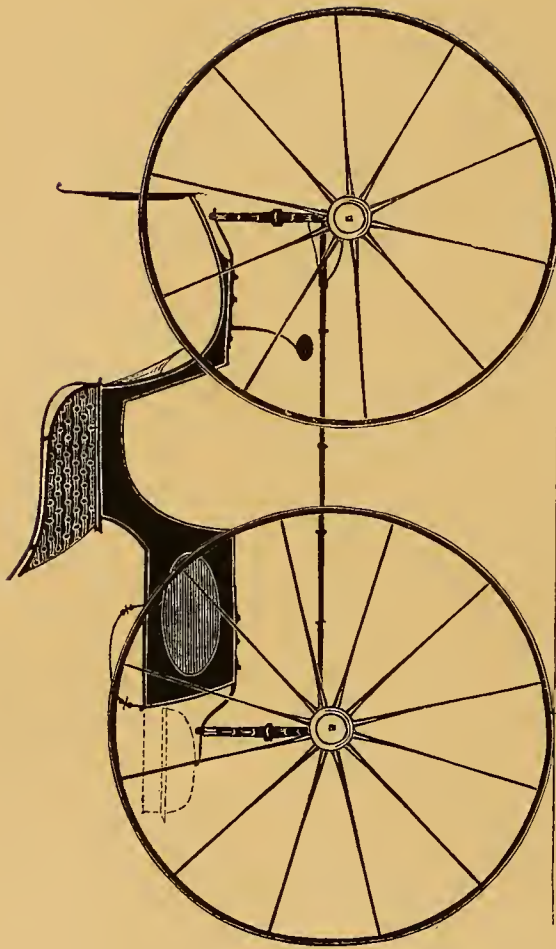

TURN-OVER SEAT BUGGY.— $\frac{1}{2}$  IN. SCALE.

*Engraved expressly for the New York Coach-Maker's Magazine.—Explained on page 229.*





DEVOTED TO THE LITERARY, SOCIAL, AND MECHANICAL INTERESTS OF THE CRAFT.

Vol. II.

NEW YORK, MAY, 1860.

No. 12.

### Miscellaneous Literature.

For the New York Coach-maker's Magazine.

#### THE AUTOBIOGRAPHY OF CALEB SNUG, OF SNUGTOWN, CARRIAGE-MAKER.

##### CHAPTER VIII.

Mr. Flatt hastens to New York—Mr. Wagon seller rises to the position of a self-installed "agent"—Tricks of the trade—Mr. Flatt finds a new house to dispose of his carriages in New York—New-York Journeymen in country shops—Mr. Wagon seller's business policy—Wagon seller's large order, and how it was disposed of—Wagon seller absconds.

SATURDAY night following found Mr. Flatt on board the Tryall, bound for New York. No wagons were to be seen among the sloop's cargo on that occasion. As no steamboat had yet riled the clear waters of the Sawgetup, this partiular voyage must have proved a tedious one; and had a true record been left, it would doubtless have shown that when "a calm" overtook the vessel, Mr. Flatt—a thing unusual with him—would have been seen laboring at the oars. I said unusual, because *his* ambition for laboring himself was not as remarkable as his taet in making others work. This, you know, is always the ease with "great minds." Manual labor is beneath their ideas of dignity, *and should be done only by mechanics and slaves!*

Duly landed at Peek-slip, our boss hastened into Canal street, to find Mr. Wagon seller, and *to find* that the greater part of his earriages had been sold, but the repository man said he had not yet got his pay for the last sales, although he had disposed of them at low pries. Boss Flatt, on learning this, and observing the *vacancy* in the repository, nervously coneluded that he was "sold," indeed! Under this impression—if he earried out his usual praetiee when excited—off came his hat, and a terrible seratching of the head followed. As he left the place, he found, on easting his eyes upward, that his old eustomer had added "agent" to his former name, over the door of the repository. Rushing up Broadway in a fit of frenzy, he happened to see, passing by, one of his own earriages, and rudely hailing, he inquired of the oocupant how much he had paid for it. The gentleman, without any hesitation, said he had given four hundred and fifty

dollars eash. Here was another cause of vexation. Mr. Flatt had been told by Mr. Wagon seller that he had been *obliged* to sell this identieal earriage for three hundred and seventy-five dollars on six months' time—another "triek of trade," thought he.

The above is a subterfuge well known to those initiated, but, to unsuspecting eountry earriage-makers, such tales have often been told—and believed too—when these "Wagon sellers" have long since received the money, and are poeketing the use of that not their own. It is a *sharp* way of doing business on a false eapital, leaving the eountryman's hands "to grumble" at the return of each Saturday night—*or was in a less honest day than the present!* Disgusted with such ehieanery, Mr. Flatt, after opening a trade with a more reputable firm, Messrs. Hubbs & Handle, turned his baek on Gotham, for Sawgetup.

The Tryall, although rated a fast sailer, did not reach Sawgetup in less than forty-eight hours, although the voyage was under forty-five miles,—caused by head-winds and ealms. The news of the sad losses of the respectable firm of Flatt & Towner in New York, soon found its way to the ears of the eountry town, and threw a gloom over the minds of its business men. However, with the forbearanee of ereeditors, and the sympathies of neighbors, the firm was able still to continue business, although on a somewhat smaller seale than previous to this cheek by misfortune. Orders eoming in slowly—at the period of which we write, there were little or no earriages built in New York eity—by discharging a few jours., and *driving* the boys a little harder, Mr. Flatt was still able to turn out a number of wagons to the order of Messrs. Hubbs & Handle; but as this last house had more of an honorable pride in selling good work, than did Wagon seller, the difficulties for suiting them with earriages were increased. This was made somewhat more so by the firm in keeping on more green hands than praetieed workmen, *because such were cheaper.* Thus matters continued for some months, with complaints as to the style as well as of the meehanical construction of the work, until, finally, the firm was literally driven to looking out for a foreman who was competent to designing for the eity market. The man was soon found, and reeommended by the firm in New York; and, for that day, was a good and ingenious workman, but, like to Mr. Considerable, was prone to dissipation.

At the risk of being charged with digression, I would here remark, that it was formerly popularly believed among mechanics especially, that almost all good mechanics were given to strong drink. At least, this was the opinion of men in the rural districts. I am happy to find, at this distance of time, that this belief was founded in error. Those who went, or at least were sent, abroad, were such as could not govern their appetites in large cities where every corner grocery is a dispensary for liquid poison, and, consequently, were compelled by necessity to go where good workmen were required and scarce, to find work at all; since where the men are plenty, the most sober have the preference, even should they not be quite as good mechanics. This being the case, forced the intemperate into the country, where the good workman found employment, and was borne with in his cups, while the intemperate and poor jour. soon found his walking-papers. From this circumstance, we are inclined to think, this vulgar error gained ground, until it had become a sort of proverb.

Two years having now passed away, and Wagonseller, by some freak of good fortune, or from policy, having paid all his former indebtedness, in the language of Mrs. Flatt, "had become an honest man, for he has now paid us up every cent he owed, although we had signed off, with his other creditors, for twenty-five cents on the dollar." As will be seen in the sequel, this *ruse* on the part of Wagonseller soon opened the way for further and renewed dealings with the Sawgetup firm, especially as the re-instated dealer was not and never had been as particular in finding defects in the work supplied, as the Broadway firm had. At first, the late "burst-up" dealer, having by some means the funds, preferred paying for his work as it was supplied, with the five per cent. off. This practice, with the facts before the public that he had paid off his old debts, without being obliged to by law, confirmed it in the public mind that Mr. Wagonseller was a true specimen of genuine honesty. Occasional intimations of former trickeries, from individuals, had very little effect in injuring the credit of Mr. Wagonseller, since the fact of his "paying as he went," was evidence that he had plenty of money, and where that is the case, a few months serves to establish any man's credit in the minds of an enterprising community.

Thus matters stood when Wagonseller, for his own amusement, on invitation, visited Sawgetup, bringing along with him his dog and gun, and, with his other notions, a *good supply of brass*, which in some instances is found equally as valuable as the more precious metals in paying the possessor's way along through life. Agreeable in his manners and prepossessing in his person, he very soon took with the "old woman," and nothing within her power which she could do to make his visit agreeable, was left undone. In fact, Mr. Wagonseller was declared to be "a gentleman in whom the most implicit confidence might be placed, and with whom, in view of his having paid up old scores, it would be safe to trust *all our carriages, should he want them.*" The New York "Repository man" consequently left with *our* house, to be filled, a large order for barouches, chariotees, gigs, and light wagons, for the spring trade, and "as the order was large, a little time *might* be wanted, until trade opened well, and some of them could be sold off." Of course, so honest and *good* a customer as Mr. Wagonseller had always been, must be accommodated with a little credit, and

served with punctuality. It is needless to say that in Sawgetup carriage-making was *good* for that winter.

When spring opened, the firm had several thousand dollars' worth of carriages ready to be shipped to New York for Mr. Wagonseller, and if, when made by boys, they were not quite as well finished as they might have been by older and experienced workmen, yet Mr. Wagonseller was not very particular in his criticism of the work accepted, since the prices to be paid, *when sold*, would permit them to be offered at low figures, thus securing a monopoly of the trade.

Before we proceed further, we may as well state here, that, although Mrs. Flatt thought Mr. Wagonseller a gentleman, still the knowing ones in New York *thought* him rather "too fast" for a long race. Certain ominous shakings of the head and significant whisperings forebode a storm in prospect that every prudent man would strive to escape. Consequently, *the gentleman's* credit was fast declining in his neighborhood, which caused a run upon him too strong for comfort. Mr. Springsteel, in the same street, who did his jobbing, found, on examining his ledger, that it was about time he had a settlement of accounts, —and so with many others. This was the turning of the tide, which Mr. Wagonseller had sufficient sagacity yet left to foresee; so he made an auction at once, "terms cash," and sold out entirely, to the highest bidder, pocketing the proceeds, and "cutting stick" for Texas *via* Philadelphia. At the latter place Springsteel overhauled the *gentleman*, where he gave him the choice of either going to jail, or of "forking over." Wagonseller was too much of a business man to dream over the matter long, so he paid up in full Springsteel's bills, was set at liberty, and has never been heard of since!

[It is with reluctance we find ourselves obliged to carry this subject into the third volume. We were in hope of completing it here, but to do so would be to spoil the biography. Caleb's experience as a "boss" will prove interesting to our readers, who may follow him out in his story.—Ed.]

For the New York Coach-maker's Magazine.

### STORY OF A SABER-CUT.

BY JAMES SCOTT.

(Concluded from page 208.)

"LONG before sunrise one morning our corps was sent out to surprise, if possible, a party of the enemy known to be posted on the proposed route of the train. Their vigilance, however, rendered the expedition fruitless, for we found nothing but deserted camp-fires and the debris of an early breakfast. In pursuance of orders we continued to advance until the middle of the afternoon, when a halt was called, to await the approach of the main body. The scene in the midst of which we encamped presented a charming combination of ruggedness and soft, quiet beauty; but by far the most interesting feature of the landscape to us, was a herd of wild cattle grazing in a distant meadow. Tired, as most of us were, this tempting opportunity of obtaining a supply of fresh beef aroused us to action, and a hunting party was soon organized, the command of which was given to me; for I had been appointed to the rank of sergeant to fill a vacancy made by

a bullet. We sallied forth with high hopes of both sport and provender, but in the former we were disappointed; for, cautious as was our approach, the cattle became alarmed ere a shot was fired, and the consequence was a long chase that completely dampened our ardor; a couple of lazy cows were at last brought to earth, and we abandoned the hunt. Cutting up the carcasses, we slung the meat on poles, to be carried on the men's shoulders, and started to return, but had not gone far when some one happened to recollect that the hearts, livers, and tongues were left behind. This proved a sad oversight, for these delicacies had been set apart for the officers' mess. I was in a dilemma; for short as the distance was the men were completely exhausted, and it seemed cruel to send one of them back on an errand apparently so insignificant. After a few minutes' consideration, I determined to return myself; so I told the men to proceed, and I would overtake them before they reached the camp. Upon regaining the scene of slaughter and recovering the meat, it struck me that I might find a shorter route back than that taken by my men; there was a rising ground to the right of where I stood, and ascending that, I could see the smoke of our camp-fires floating among the tree tops away to the eastward, and, not more than a mile off, in a bee-line, while the course pursued by my companions would, I judged, lead them double that distance. Having shaped my course, I descended, and keeping a sharp look-out for lurking foes, made my way with all possible speed through the intervening expanse of tangled chapperal, lofty forest trees, and clumps of thorny cactus.

"I had accomplished, perhaps, one third of my journey, when, in crossing a strip of sandy soil, my eyes fell upon the deep prints of a horse's feet. Stooping to examine them, I was somewhat startled to see that they were fresh. The officers of our company had no horses with them, and yet, the animal that made the tracks before me, was heading towards our camp. What could it mean! It must be a Mexican, I reasoned; but why that direction! There was but one solution, he was reconnoitering our position, and I forthwith determined to reconnoiter him. Fatigue was forgotten, and the meat thrown into a bush, to feed the buzzards; all my energies were aroused, and with the caution and avidity of an Indian on the war-path, I started on his trail. Fresher grew the foot-marks, quicker beat my heart, and my fingers nervously sought the lock of my musket; but neither eye nor ear could detect the presence of the horseman. I was beginning to feel discouraged, and thought it strange he should approach so near our bivouac, when the trail suddenly diverged to the right and entered a thick clump of tall bushes. I had turned to follow, when an object met my eyes that sent my weapon to my shoulder in an instant—it was a horse's head peering at me with great, staring eyes from among the dark, heavy foliage! Darting behind a tree, I eagerly sought a glimpse of the rider, but in vain. Shifting my position gradually, I saw that the saddle was empty, and that the animal was fastened by the lasso to a short limb;—the owner had doubtless gone to make his observations on foot. Gliding from cover to cover, I examined the thicket thoroughly, and was satisfied of his absence; then approaching the mustang, I searched the ground for foot-prints to mark his course. I found them, and *they, too*, pointed towards the camping place; so my conjectures, as to his object, were evidently correct: he was a spy! Following his tracks about twenty feet, I ensconced myself behind a tree, and

awaited his return; but, remembering that a carbine hung at his saddle-bow, and the butt of a pistol protruded from one of his holsters, I thought it prudent to return and render them useless by emptying the priming, having done which, I returned to my place of ambush.

"How long I crouched there, with eyes and ears intently on the alert, I know not—it seemed a week, and my patience was sorely tried. I was in the act of slapping, as noiselessly as possible, the breach of my musket to insure the action of the priming, when, to the right of me, I heard a sharp click, which was instantly followed by the report of a pistol and the fall of a piece of bark within an inch of my head. To turn and fire at my assailant was the work of an instant, but the hurry spoiled my aim; through the smoke I saw the figure of a man, in the garb of a Mexican officer, darting towards the horse, drawing his saber as he ran. I was nearer the animal than he, and with a few bounds I stood with leveled bayonet to dispute his passage. I knew that Spanish blood was hot, but I had never seen on human countenance such a concentrated expression of fiendish hate and baffled rage as shone on the livid face of the man before me. When his eyes met mine, there was, too, a mixture of surprise in his look that puzzled me. I knew the meaning of it afterwards; but of that anon.

"'Surrender!' I cried sharply; 'down with your sword, or you die!'

"'Al instante' (immediately), he hissed sarcastically, as he stepped back a pace or two, and flung his hat on the grass, then, shaking his saber wildly, until it rang in the hilt, he advanced upon me with the eager, yet stealthy step of a famished tiger.

"Few men can bear to be looked at by a pair of angry eyes without becoming, in turn, angry at all events; that man's motions and look of hate kindled within me a feeling as deadly as his own, and I met him half way.

"No word was uttered on either side, nor were they needed. Slowly he circled around me for a few seconds, as if nursing his ire and gathering strength for a blow. My eyes and bayonet followed him warily, keenly—up went arm and blade, and a quick, terrific swoop was made at my head. Crouching, and rapidly interposing the barrel of my musket, it broke the force of the blow and shivered his weapon into a dozen fragments; a warm gush of blood spurted from my cheek, for the point of his steel had reached me, and made this ugly cut. With a yell of triumph I made a quick lunge at his breast, which he nimbly evaded, and grasping my musket, closed with me in a firm struggle for its possession. Being an expert wrestler, I tried to trip him, but he showed a skill at that game equal to my own, and I failed. We each put forth our utmost strength in abortive attempts to wrench the weapon from the grasp of the other, until strength and breath alike gave out, and we paused as if by mutual consent, and stood looking our hate into each others eyes. In that brief moment of respite from deadly peril, there flashed through my brain the memory of a school-day struggle for a ball-club with a boy who had stolen it from me. We had stood panting with exhaustion after a hard scuffle, even as this man and I *now* stood, and a cunningly dealt blow had lost me the victory, aye, nearly lost me life itself. I remembered well *how* that blow was inflicted, and the thought sent an exultant thrill through my frame—I had him in my power! Controlling my countenance and keeping my eyes fastened on those of my ad-

versary, I slowly and cautiously raised my right foot and threw it backwards, then gathering all my strength, I drove it into his abdomen with sledge-hammer force; he dropped as if struck by a thunder-bolt.

"I was in the act of securing his hands and feet with the lasso from his saddle-bow—I knew he would revive shortly—when a strong party of our men, headed by the captain, arrived upon the scene. The hunting party had reached the camp and reported my absence, and shots having been heard in the forest, it was supposed that I had fallen into the hands of some prowling party of the enemy: hence their presence. My wound was bound up to stop the bleeding, and the case of my prisoner was attended to. He soon showed signs of returning consciousness; so we set him upon his horse, with a man behind to sustain him, and guide the animal. Before we reached the camp he had recovered completely; and, strange to say, the determined courage he had displayed in our rencontre had given place to the most abject terror; it was a pitiable sight, and drew remarks of a contemptuous nature from the men, who would otherwise have regarded him with respect, in view of his gallant resistance.

"The main body of the troops had arrived, and we conveyed the prisoner to head-quarters to be disposed of by the commanding general, into whose presence we were soon ushered. A Texan Ranger who spoke Spanish, was sent for to act as interpreter; and the examination was commenced by an inquiry as to whether the prisoner belonged to the regular army or the guerrilla forces.

"When he answered this question, the Texan seemed startled, and gazed at the man earnestly for a short time; then a sort of half smile broke over his stern face, and turning to the general he said:—

"This man is no Mexican, he speaks Spanish with a strong English accent, and I'll wager my life he is a deserter from our army. Indeed, I'm almost certain that he is a fellow that joined Hayes's troop on the Colorado, and afterwards disappeared with his arms and horse. The voice and face are the same; but that straight black hair bothers me—ah! see how he quails, it's a wig, or I'm a nigger! Let's see, my beauty, the quality of your hair."

"The Ranger advanced as if to make an examination of his cranium. All eyes were turned upon the prisoner: he was pale as death and trembled perceptibly; but mastering his agitation he exclaimed hurriedly, and in good English:—

"I protest against this proposed indignity; this man is mistaken, he is deceived by a mere chance resemblance; I am an Englishman and have been in Mexico five years. I have never been in Texas, and never belonged to your army. I—"

"If he is mistaken," interrupted the General, "what do you fear? Why this evident terror? Examine him, Sir!"

"The culprit became furious, and made a show of resistance; but once in the grasp of the stalwart trooper, he was as a babe. In an instant the hair was raised from his forehead; a single look, a quick jerk, and, with a triumphant laugh, a full wig of black hair was held aloft, revealing a scalp covered with short, crisp curls of a light brown color. One glance at the pallid face of the captive, metamorphosed as it now was, and the vindictive fury with which he assailed me in our rencontre was explained; for in that shivering wretch I beheld the soi-disant dandy and absconding defaulter, *Le Blond!* He was much

changed since I had last seen him: the unmistakable brand of dissipation was legible on his face, and the air of good breeding and refinement that had so well masked his corrupt heart, had given place to a ruffian-like bearing, that to say the least became him full as well in his new character of renegade and deserter.

"His case was soon disposed of. The fact of his desertion from the Texan Rangers was fully established, and having been captured in the uniform of the enemy, acting as a spy and fighting against his own countrymen, it is not surprising that he was condemned by a 'drum-head' court-martial to be shot at sunrise on the following morning. Fate, however, decreed that he should die otherwise. In the night he succeeded, by some means, in freeing his ankles from the fetters that bound them; and rushing upon the man set to guard him he clutched his throat, doubtless with the intention of choking him, possessing the musket, and making his escape; but he failed. The man, a large, powerful fellow, shook him off, felled him to the earth, and in the passion of the moment drove the bayonet through his body, killing him instantly.

"On issuing from my tent in the morning, I found some men of the guard digging a trench to receive the body, which lay a few feet distant. Approaching, I gazed long and earnestly on the pale, distorted face of the dead, and thought bitterly of the living; thought of her who had basely trampled on my heart, and sent me forth an aimless, hopeless wretch to traverse alone the dreary waste of time, whose only terminus is the grave. I found, while looking upon that lifeless clay, how futile had been all my efforts to stifle that one ruling passion of my existence; and I wondered if all men had hearts like mine—hearts that were living, palpitating curses. But, as I said before, I was young then—I have mastered myself now.

"At Cherebusco my left arm was shattered by a piece of grape-shot, and I was discharged as unfit for service. I reached New York in safety, and went to my old home to see after my property. It had increased in value; and finding it would yield sufficient to support me handsomely, I was content to settle down into the easy, vagabond kind of life I now lead, traveling about to kill time, and memory."

"And Annie Ross," I asked, "what became of her?"

"She married an eminent lawyer, and contrary to the expectations of all who knew her, made a good and exemplary wife. On the eve of her marriage I received a letter from her in which she said:—'I can never take upon myself the duties and responsibilities of a wife, until I am assured that you forgive me the great wrong I have done you. When too late, I discovered the fearful sacrifice of my peace I had made in discarding you for a gilded villain; my heart awoke from the fatal illusion only to love you with a power as intense as it was hopeless. My punishment has been terrible, is yet, and will be while I live. My father is dying, and wishes me married; I must take the step, though my heart goes not with my hand. Do you, can you, forgive me?'"

"I did, fully, freely, as I myself hoped to be pardoned in Heaven, and I prayed that He who 'shapes our ends' might strew her path with flowers. One year ago her husband died in Washington, leaving her with a little boy of eight summers; his name, they tell me, is Oscar, the same as my own—strange, is it not? I love the little fellow, although I have never seen him; but I will soon. In

a few weeks I intend to visit them; I can now do so with safety, for the old love is dead, quite dead."

There was indefinable expression about that scarred face

as he concluded, that made me fancy it would not be hard to bring it back to life and strength. "A consummation most devoutly to be wished," is it not?

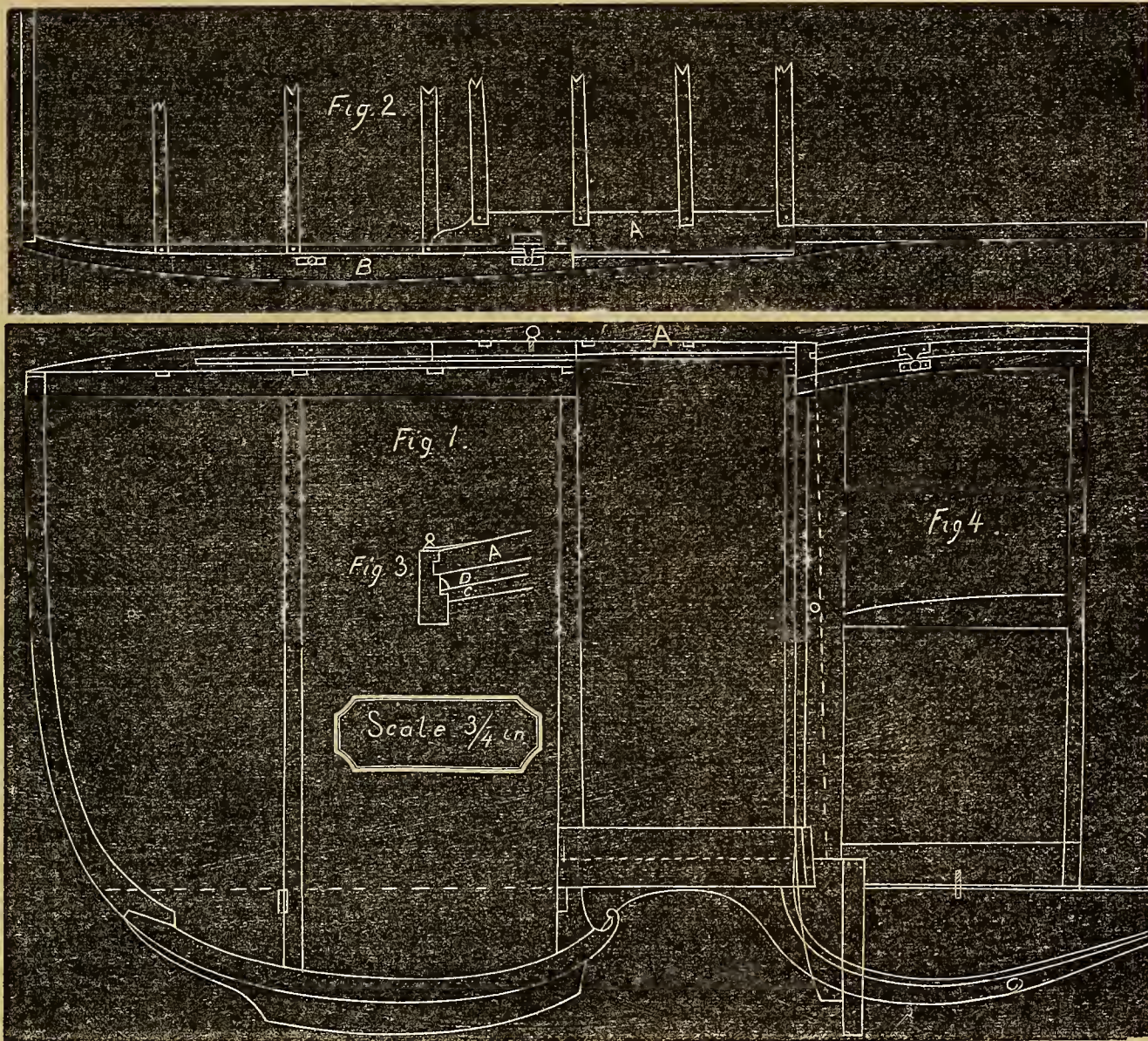

For the New York Coach-maker's Magazine.

GEOMETRY OF CARRIAGE ARCHITECTURE.

BY A PRACTICAL COACH-MAKER.

PART THIRTEENTH—BODY CONSTRUCTION.

FIGURE I. shows the side section of the roof-rail of the Transpose Rockaway on plates XXXVII and XXXVIII, which requires to be about  $4\frac{1}{2}$  inches wide, and straight on the inside so far as the slide-roof runs. (See figure 2.) The side-piece A is grooved into the roof-rail B, as shown in the end section, Fig. 3 (1 inch scale). The roof-rail B is lightened out to about  $\frac{3}{4}$  inch, where the upper roof runs, leaving a projection underneath for attaching the main roof. When the cloth for the roof is drawn over, and nailed in the corner, there should be a corner moulding, white leaded and nailed into the corner D, to make it water-tight. Fig. 4 gives a front section of half of the partition, which is made in the usual manner. The insides

of the front-seat must be arranged so that they will be square, for the partition to fill up when it is shifted from between the pillars to the front of the seat. To secure it in its position then, it must have two pins in the bottom, to drop into holes in plates let into the seat to receive them. At the top it must be secured by plates and thumb-screws from the front of the roof. The sliding-roof must be secured in the same manner with two nuts let into the side-rail, so that when the roof is pushed back, the same screws will secure it, in its place, there.

[We have now about exhausted this subject, as applicable to American carriage architecture. In our next volume we intend to give a series of diagrams, on a reduced scale, from the London *Carriage-Builders' Art Journal*, under the head of "English Carriage Architecture," with such explanations as will render the subject interesting to the American coach-maker. This series, embracing carriages not built here, will furnish lessons for study as well as usefulness.—ED.]

## COACH-MAKING HISTORICALLY CONSIDERED AND INCIDENTALLY ILLUSTRATED.

BY THE EDITOR.

### CHAPTER XXII.

THE coach-makers in New York, in 1810 and 1820 enumerated.—Miln Parker's challenge to the world, accepted with modifications by Abram Quick.—Quick wins.—The first landau built in New York.—Parker's "volantes" *blowed* by his smith, Phil. Vermilyea.—The New York coach-makers aroused, by the prospect of being injured by the practice of selling country work in the streets.—The origin of carriage-repositories.—Causes of the decline of coach manufacturing in New York.—Concluding remarks, which end our history.

WE now come down to 1810, when we find 14,600 names as heads of families in New York city, with about 28 shops named as coach-making. These were, Wm. Ross, 208 Broadway, corner of Fulton; Burtis & Woodward, 280 Broadway, where A. T. Stewart's dry-goods store now stands; John Higin, 368 Broadway, where Miner & Stevens lately carried on the business; Alex. C. Wiley, 392 and 482 Broadway; Fred. Bomiler, Broadway near Spring; John Bloodgood, 5, 7, and 9 John street; Jas. & John Warner, coach and harness-makers, still each for himself, one at 7 the other at 9 Barclay street; Berrian & Cullum, 23 Chambers street; Jacob Vanderpool, 82 Chambers street; Henry Stibbs, 34 Vesey street; Nathaniel Jeroleman, 90 Reed street; Abram Quick, "coach-painter," 62 New street; Daniel Fraser, 39 Frankfort street; Jacob Crissy, 32 Robinson street; Geo. Griffing, 40 Chapel street; Griffith Griffith, 437 Pearl street; Jas. Brower, 11 Partition street; Cornelius Vanallen, (before written Van *Anlen* and Van *Aller*.) 56 Leonard street; Thos. Thorne and Robert Hardy, both at 57 Walker street; Jacob Peterson, "coach-maker and wheelwright," 20 Mott street; John Woodward, 40 White street; Ozeas Smith, 12 Batavia lane; Jas. Simpson, Bancker, now Madison street; Thos. Lincoln, 13 Magazine street (?); Samuel Hallet & Henry Hamilton, both in the Bowery, near North street, since called Houston street. These are all called coach-makers; but some of them were hardly deserving of the name, when the work done was taken into consideration. Such have been the changes in this city, that at this writing *not one of the places named above is occupied by a coach-maker.*

In 1817 Miln Parker was residing at 5 Crosby street, and Abram Quick had removed to 52 and 54 Broad street. These two gentlemen figure so prominently in our history, subsequently, that this should be noted here.

The only persons still in the business in 1820 who have been mentioned in our list ten years earlier were, Cornelius P. Berrian, 23 Chambers street; Jas. Brower, Suffolk, near Rivington street; Geo. Griffing, 40 Chapel street; Nathaniel Jeroleman, 50 Leonard, near Chapel street; Abram Quick, still at 52 and 54 Broad street; and Wm. Ross, who had removed from 208 to 405 Broadway. A "nest" of Rosses had now got into the business: Wm. & John E. Ross, 138 and 140 Fulton street, previously known as Fair street; Wm. S. Ross, 146 do.; and Jas. Ross, 409 Broadway. John C. Vanaulen had now not only changed the orthography of the name, but represented the family in the business at 54 and 88 Leonard street. The following opposition shops had sprung up during the previous ten years: Nicholas Lawrence, 412 Broadway; R. P. Lawrence, 5, 7, and 9 John street (afterwards Bloodgood & Lawrence); Daniel

Stevens, 407 Broadway; Oliver & Parker, 348 Broadway; Miln Parker, coach-maker and repository, Broadway, near Spring. This appears to be the first repository so named. In 1825, Mr. Parker was at 517 Broadway, which undoubtedly was "near Spring street." He left in 1827, and went to Yorkville then, a few miles *out* of New York, where he continued until 1828. He was subsequently in New York city; Robt. G. Hardie, 14 New street; Wm. Chapman, Church, corner Leonard; Gilbert Bowne, 26 Thomas street; Peter McNeil, 164 Chambers street; William Mitchell, Collect, corner Anthony; John Riker, Lispenard near Church; Wm. C. Smith, Hester near Broadway; John Woodward, Jr., 127 Orange street; John Foster, 33 Jay street; Jas. Brady, 253 Greenwich street; Thos. Charters, 26 Charlton near Hudson; A. Brown, Laurens near Prince; Wm. H. Pinckney, 154, and Wm. Slaek, 214 Bowery; Jas. Cleland, Thompson near Spring; and Jas. Coe, one of that name at 17 Mulberry, and another at 15 Bancker (Madison) street. Subsequent to this (in 1827) Cornelius P. Berrian had taken possession of number 7 John street, formerly occupied by Bloodgood & Lawrence. In 1816, A. Quick had removed to Broad street from 16 Marketfield street. In 1827, Jas. Brewster of New Haven bought out Mr. Quick's establishment in Broad street, and took in Mr. John R. Lawrence as partner in the business.

In conversation with Mr. Thos. W. Thorne, now president of the National Fire Insurance Co., one of the oldest ex-coachmakers now living, and who worked for Bloodgood & Lawrence in 1812, we were told that "crane-neck coaches were made in America as early as 1805." This, however, must be a mistake. Richard P. Lawrence had been burned out at the corner of Chatham and Duane streets in 1811, and afterwards associated himself with John Bloodgood, at 7 John street.

The following story, which appears to have created much interest somewhere between 1820 and 1825 (some say in 1822), is related by the older members of the craft. Miln Parker, who appears to have had the bump of self-esteem largely developed, through the public press *challenged the world* to compete with him in building a gig. Abram Quick *quickly* "took him up," but stipulated that the best made should have the two,—Parker's offer,—and in addition thereto forfeit \$500, and a suit of clothes to the referees. Both were to be made without paint "putty" or trimmings. Parker employed Otheal Smith to make his gig-body, and Phil. Vermilyea to do the iron work. Quick's was made by James Brady, and ironed by—Davis. When both were ready, the jury of carriage-makers, Robert Hardy, Cor. P. Berrian, and Richard P. Lawrence, decided that Mr. Quick's gig was the best. Parker reluctantly parting with his gig, Mr. John R. Lawrence was sent to take it away. Mr. Parker finally said, Mr. Quick could have the gig when it was completed in the wood and ironwork when he would send it along, which he did in a few days after.

The first landau built in New York is said to have been done in the shop of Wm. & John Ross, at 138 and 140 Fulton street, by Jas. Ross. Slaek, who appears to have had a nice taste for good work, passing by the shop, Ross cried out, "What do you think of this, Slaek?" meaning the landau. Slaek passing his hand over the panel (the way in which all good workmen decide the qualities of a job), sneeringly said, "O pretty well, *considering who made it,*" and went on.

Miln Parker seems to have turned his chief attention to the manufacture of "volantes" for the Cuban and Mexican markets; this kind of carriage being a great favorite with the Spanish ladies. Phil. Vermilyea, who appears to have been Parker's "great blacksmith," as well as *blower* in particular, seems to have headed a procession through the streets of the city by Parker's direction, for the express purpose of showing off his volantes, and "astonishing the natives." Coming to a halt, "Phil." took especial pains to say to the gaping crowd at every opportunity, "Gentlemen, those fine specimens of work were made at Mr. Parker's shop in Broadway, *not* by the Rosses in Fulton street;" between whom and Mr. Parker there appears to have been a rivalry in business.

About the period of which we are writing, A. Quick, Bloodgood & Lawrence, Wm. & John Ross, C. P. Berrian, and John Riker, who were the chief manufacturers, and consequently the most affected by "country work" set themselves to work to have a law passed to prevent the country carriage-makers from selling work of their manufacture in the public streets. Their chief stands were on the side-walk in front of Trinity church, opposite Wall street in Broadway, and in front of the Tontine Coffee House, corner of Water and Wall streets. For this purpose a meeting of the city carriage-makers was called together. Among other things, A. Quick, who was an off-hand and free-spoken man, said, "Gentlemen, we are in a similar position with our Savior on the cross—we are between two thieves—Connecticut on the one hand and New Jersey on the other."

This movement on the part of the New York carriage-makers, originated the establishment of repositories for the sale of ready-made work. A man by the name of Burns; but whose name we have not been able to find in any Directory of the city library; is said to have been the first to open a repository for the sale of country work, at 61 Walker street, in the building now occupied as a store-house by the Messrs. Wood Bros., somewhere about 1823.\* At first he sold on commission; but afterwards, finding it more profitable, he bought the work, and sold it on his own account. He was afterwards followed in keeping a repository by Paul Perrin, at 34 Canal street; Isaac Mix; John Cook in Burns' place; John Thompson, at 27 Wooster street; McChesney & Lawrence in Broadway, above Canal, and since by others. A society was also formed among the journeymen coach-makers, but without much benefit to anybody. These proceedings all had the effect to drive the trade into the country, where from 1825 to 1830 the bulk of the work was done, and sent to the New-York market. Especially was it so in Connecticut, and every little village had its "carriage-maker's shop," many of them with one or more New-York journeymen. The work, much of it, is still done in other cities and country places for the New-York and Southern markets; but in consequence of the "recklessness" of some manufacturers in getting up cheap work the tide is again setting in favor of New York. The fact is, that where rents are high to get up cheap work will not pay. This fact has so long been preached by the city carriage-makers that the public who have the "tin" have come to believe it, and so willingly give a higher price for "city-made work," than

any other. The price demanded here, requires that the work should be done in the best manner to sustain a reputable position with the public; and to do his work well, the mechanic is encouraged by the price he gets for it. Presuming that our country friends do their work equally well, yet it will not bring the price; and so they cannot afford it. Such is the effect of a good reputation on trade of every description.

A few remarks will end our history for the present. We have traced the rise and progress of coach-making from its infancy, and believe it is the first ever penned. It has cost us much labor and study; our call on the public having brought us nothing to be relied upon. Our history may have its imperfections, which if pointed out will be corrected; but is believed to be correct. We have undertaken it *con amore*, as "one of the craft," and are happy to present it to the trade in connection with *our* magazine as a mirror of the Coach-maker's Craft.

#### MASTERS AND APPRENTICES.

The scarcity of apprentices in the trade cannot have escaped the notice of coach-makers, and the reluctance of a people to bind their sons to so useful and respectable a calling; and it is proposed to offer a few remarks upon the duties and treatment of each party standing in this particular relationship, to remove, if possible, the disagreeables by which the subject is surrounded. First will be the methods used for binding apprentices according to the present practice, few as they are. The most legitimate mode and most ancient method of induction is by and through the medium of the Coachmaker's Company. This Court met in their Hall, four times per annum, in Noble street, Cheapside; where, after fourteen years of age, the lad attends with his parent, or guardian, and his future master; and on the payment of the fee, which varied according to the amount of the premium (under £10, if the premium is under £100), he is bound to serve for seven years. A book is given; and the Master of the Company kindly advises the youth to give it his best attention, as it contains the duties he is expected to fulfill, and suggestions for the regulation of his future conduct. At the expiration of the seven years he appears before the Court to take up his freedom, which is done for a small fee. He is then introduced, at Guildhall, to the Chamberlain, by his master, and, on the payment of a sum not exceeding £10, is admitted to the privileges of the livery. From time to time alterations have taken place in the law on this subject, and rendered obsolete nearly all the privileges formerly held by the citizens, with certain exceptions, such as voting for members of the city, eligibility to hold office, from the lowest appointment to those of sheriff, alderman, and lord mayor, as well as a member of the Court of the Company itself. This Court is self-elected, and composed of the *elite* of the trade, chosen from their long establishment and general respectability. The Chamberlain addresses the young livery-man, congratulates him on his promotion; and he is then left to the chances in the great battle of life.

The second mode is by a simple apprenticeship. Binding before a magistrate is of the same legality, but without reference to the city of London. In any dispute or misunderstanding the Chamberlain is referred to in the first instance, and the magistrate in the second.

The third method is by articleship for any term of

\* We find in the Directory for 1819 the name of *Geo. Burnie*, coach-maker, 393 Broadway and 61 Walker street.

*Quere.* Could he have been *the* man?

years, wherein an arrangement is made between the master and the lad's friends for him to reside with them out of doors, and to receive a weekly salary; rising after the first year from 4s. to 8s., 12s., and 15s., according to circumstances, age, strength, and ability.

By the City indenture a master is bound to find his apprentice in all his wants; to live in the house, and whether in sickness or health, to maintain as well as to clothe him. This obligation has had the effect of deterring many from the risk, as well as the inconvenience of a stranger at his table; since, from the fact of so considerable a premium being paid, it is expected, as of course, that the lad, belonging to respectable friends, will be as one of the family. In the lapse of two or three years it sometimes occurs that the party shows a dislike to the business, or a distaste to the association in which he is placed. The result generally produces much discomfort, and a separation ensues.

In the second instance things work somewhat better. The lad is more under the dominion of his friends, and on this account releases his master from all responsibility as to personal conduct. Living with his relations, he is more under family influences, and grows up with a better disposition to his business and more awake to its duties; while, being allowed to retain his weekly salary, or a part, he becomes accustomed to the value of money earned by his own labor.

By the third mode he is placed with a workman in one specific branch of the business. He follows this man's fortunes, whether settled permanently in one shop, or changing among the trade; receiving a salary, gradually increasing with his age. The advantage of this plan is, he becomes thoroughly master of this particular section of the work, and the remuneration is somewhat better, as he is enabled to take a piece of work on his own account much sooner, although not so well acquainted with the practical part of the other branches.

On the termination of the period for which he is engaged, in either case, it is desirable for his improvement that he should practice the business in other shops, in order that he may learn the different styles of workmanship and the variety of form, as it is well-known that many houses are eminent in some peculiar description of carriage. For example, when Tilburies were in fashion, a maker of that name was distinguished for a favorite style, and engaged a large portion of the business of that particular class of gig. So, likewise, Hopkinson's Stanhopes were preferred. Hobson's coaches and chariots also were considered the most elegant carriages throughout the trade; and to such an extent were these prejudices of fashion led, that to this day the original of either of these makers maintains a good price. Therefore, a young workman obtaining a situation in any house distinguished by public opinion, is an advantage worth seeking, and better qualifies him for judgment in the future.

In the treatment of apprentices by masters, much consideration and judgment is necessary, more particularly when they are taken in-doors. It must not be forgotten that they have just left a parent's or guardian's house, where they have been probably accustomed to some degree of indulgence; and, all at once, a change takes place in their position. Called upon suddenly to renounce their habits, their freedom, and their enjoyments, in exchange for a difference of fare, a sacrifice of indulgence, a devotion to hard duties—and, generally, at the beginning, they are

the most irksome—it is not surprising that some repugnance is shown. It is just at this moment a master's judgment is most required. A positive and rigid rule may subdue but will hardly reconcile, and, if persevered in, will produce a spirit of antagonism and ill-will in-doors, and dissatisfaction without; with some tact, some forbearance, some kindness, and yet a proper firmness, the first difficulties may be overcome, and the boy who with a treatment of severity shows obstinacy, a rebellious spirit, and a dislike to his business, may be led to a proper appreciation of his position, submission to its duties, and a love of his business,—a valuable assistant to his employer, a credit to his family, and an ornament to his profession.—*Carriage Builders' Art Journal.*

## Pen Illustrations of the Drafts.

For the New York Coach-maker's Magazine.

FURNITURE CAR.

*Illustrated on Plate XL.*

MEMPHIS, TENN., Feb. 28, 1860.

E. M. STRATTON, ESQ.:—*Dear Sir,*—As we promised you, some time ago, to send you some drafts, we now send you one for a Furniture Car, which we built for Mr. M. L. Duncan, of this city, the extreme length of which is 18 feet 8 inches; width, 4 feet 6 inches; outside height, from bottom of sills to top rail, 2 feet 6 inches. Although it is of large dimensions, it runs extremely light—fully as much so as any car in Memphis, of a much smaller size. It is drawn with ease, when loaded, by a span of horses. This is the second car we have got up on the same principle, with the exception of the curve in the top rail. They give entire satisfaction, and can carry large loads without crowding, or rubbing the furniture, and turn short. With the superior axles used, and the setting correct, renders them very easily drawn. The springs we have used are 2½ inches wide, with 9 leaves in side spring, and 11 leaves in cross springs. They will carry 5,000 lbs. with axles 1¾ inches. On some celebration occasions it has carried a band of musicians consisting of 40 men. The construction of the car was under the immediate supervision of our junior partner, James Aiken.

L. S. BURR & Co.

MESSRS. ODELL & WATERMAN'S BRETT.

*Illustrated on Plate XLI.*

This very pretty design for a light brett has been drawn from one the Messrs. Odell & Waterman, of No. 8 Christopher street, New York city, are building for a customer. The body is made without any side swell, with paneled or close seats, as seen in the draft, and a calash top to the back seat, and mounted on four springs. Heavy iron plates, well secured by screws to the inside of the rockers, are required in a job of this kind where no perch is employed, to render it sufficiently strong for the purposes intended. Mr. Odell has recently made some improvements in perch and shaft couplings, which we hope to have the pleasure of giving soon.



## TURN-OVER SEAT BUGGY.

*Illustrated on Plate XLII.*

THIS buggy is very different from anything we have ever given before, and will make a very pretty job. The front or principal seat is paneled with imitation French-fluting, in mahogany, which is now manufactured in this city at half the price asked for that imported from Europe, and it is much smoother and better finished. The back seat, when ready for use, is thrown over and back to the place indicated by the dotted lines in the draft, and resting on the point of the back body-loop, constituting it a two-seated vehicle convenient for taking "the babies" along when traveling.

## Sparks from the Anvil.

For the New York Coach-maker's Magazine.

## FANCY BODY-LOOP.

MR. EDITOR:—*Dear Sir*, I send you, for insertion in the Coach-maker's Magazine, an original design for a fancy body-loop, in hanging up phaetons and other kinds



of carriages, which makes a very nice thing. The scroll ends, as seen in the drawing, are filed to the shape of a raised and hollow moulding, or in the form of a thread to a screw.

For the New York Coach-maker's Magazine.

## TURNING CORNERS AND SETTING AXLES.

FORT EDWARD, N. Y., March 12th, 1860.

MR. E. M. STRATTON:—*Dear Sir*, I wish you to inform me if there is a machine in use for upsetting tires, that is of any value; and if so, how much will it weigh, and how much will it cost; who makes them, and where can I purchase one, should I wish. I am a country jour., on light carriage and buggy iron-work, and have a great liking to do things in the most systematical manner, and am in for experiment. I read your Magazine, and find some very fine things there; I would like to make a few suggestions in it, did I feel myself able.

I noticed in the March number a new method of forming square corners in a bar. It is a very good one, as it makes a good job. I have a manner which I practice, which I think is less labor, and answers every purpose. Should you think it worthy of notice, it is this: By cutting a corner out of the iron of a large bar, and merely striking a blunt-edged chisel into a small one, and bending until the parted sides touch, and then welding, it makes as nice a corner as could be wished on any job, and as durable as can be required.

I shall be pleased to hear from some of the old men

in regard to setting axles, be the wheels either dishing or straight as the case may be, if there is a rule that will work invariably. Yours, truly, J. G. P.

[A correspondent has already favored us with an article on setting axles, which we design to give in our next number. Meanwhile a response to the inquiries of J. G. P., for publication, will be very acceptable. The subject is one which cannot be too fully discussed in these pages; and study, properly directed, may prove beneficial to all concerned.—ED.]

## DAVIES' SEGMENTAL LOCKING-PLATE.

This plate, patented in England, as may be seen in the drawing, turns upon two centers, thereby avoiding the dangers of weakening the front-axle by the application of the king-bolt. By this invention, the front and hind wheels are brought nearer together, allowing of a shorter carriage-

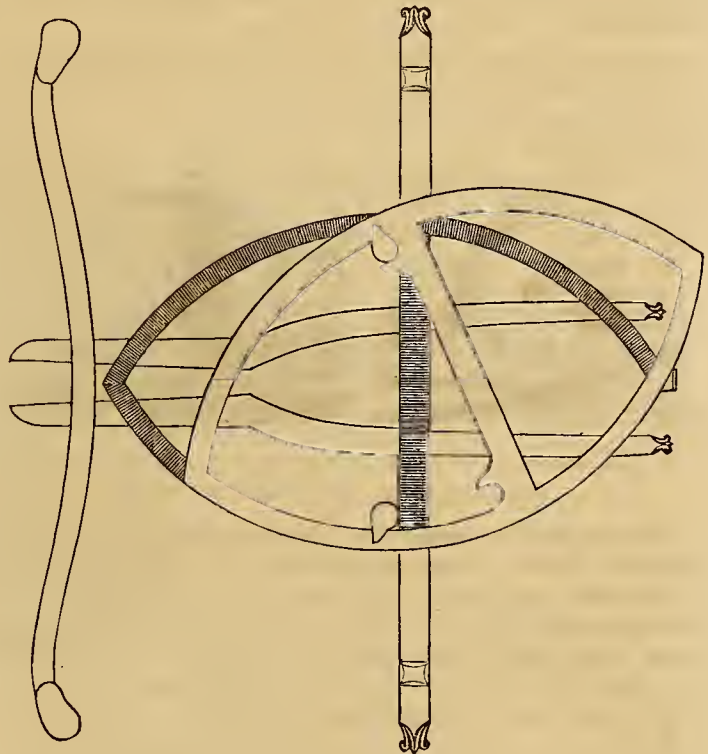

part, and permitting the vehicle to which it may be applied to turn in a smaller circle. This contrivance may profitably be substituted for some of the worthless "perch couplings," with which the American public has heretofore been "bored," and after purchasing which so many have been sued for using.

We have some very fine articles for this department of the Magazine for June, and have every reason to think that our next volume will exceed in interest any that has preceded it. With the present arrangements for "Sparks from the Anvil" from practical workmen, we are satisfied we shall meet every reasonable expectation of our patrons.

## Paint Room.

For the New York Coach-maker's Magazine.

### VISIT TO MESSRS. STIMSON, VALENTINE & CO.'S VARNISH ESTABLISHMENT.

To the Editor of the N. Y. Coach-maker's Magazine.

SIR,—About two years since I received a polite invitation to visit the well-known factory of Stimson, Valentine & Co. of this city—the largest varnish-manufacturing establishment in New England, and there to witness the process of producing an article that had for years been familiar to me, but of the “*modus operandi*” of whose manufacture I had always been ignorant.

Having been negligent of the first invitation, it had passed from my mind, until a few weeks since; I received a similar compliment and availed myself of the privilege thus kindly extended. The visit proved so entertaining and instructive, that I concluded to furnish you with a brief outline of it. Should there be any thing in it you may deem worthy to place before your readers, it is at your pleasure.

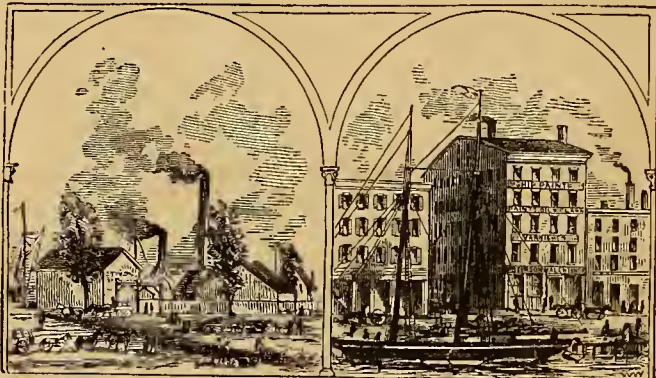

VIEW OF MESSRS. STIMSON, VALENTINE & CO.'S VARNISH MANUFACTORY AND WAREHOUSE.

The factory is situated at Riverside, Brighton, on the banks of Charles river, about three miles from Boston. Its outward appearance, like that of other large varnish establishments, is not at all attractive to the beholder. There is nothing in the exterior construction of the building which indicates that there is within, that adaptation and perfection of arrangement so requisite to carry on with success so complicated a business as varnish-making; but for completeness of finish, and the perfection of those fixtures and utensils necessary and peculiar to this business, this factory is not surpassed by any other establishment in this country. The buildings, four in number, are of brick, one story high, and each having its specific use. There are the store-rooms, where all stock is kept before being manufactured; the gum-room, melting-room, and a large room where all the better qualities of varnish are refined after being made; this room is admirably fitted up, is kept free from dirt and dust, and at a uniform temperature, which has a wonderful effect upon new-made varnishes. It contains 30 or 40 neatly painted cans; each, holding about 300 gallons, being numbered and kept for its particular quality of varnish. There are several large copper kettles in different parts of the premises, each one for its own particular use, and they are all brought into requisition as the stock upon hand needs replenishing.

This firm is fortunate in having secured the services of a gentleman (Mr. John Babcock) whose ability as a practical manufacturer is evinced by the high esteem in which his varnishes have always been held by all who have used them. Mr. B. had seven years' experience in the largest varnish-making establishment in Newark, N. J., he has been about four years connected with this firm, and his reputation as a skillful and successful maker is too well known to need any comments from me. I was kindly shown through the various departments, and the different and peculiar ways of manufacturing different kinds of varnish were commented upon.

It will not be expected of me to give a detailed account, and go through the entire process of manufacturing varnish with that minuteness I could wish. My space will not permit more than a few general remarks upon the various qualities of varnish, and of what they are composed.

The principal ingredients used are gum copal, linseed oil, and spirits of turpentine: these articles form the bulk of all varnishes; but in addition to these, the following are a few of the many other ingredients used to obtain the various kinds wanted, viz.: sandarach, shellac, mastic, Venice turpentine, mastic in tears, dried copperas, white copperas, litharge, sugar of lead, alcohol, gum aurum, amber, &c., &c.; but the most prominent of all is the gum copal. This article exudes spontaneously from two trees, the *Rhus Copallinum* and the *Eleocarpus Copaliferus*, the first of which grows in South America, the latter in the East Indies. A third species of copal-tree grows on the coast of Guinea.

It is found in lumps of various sizes and of different shades of color, from the palest green-yellow to darkest brown, deposited in earth and sand. Many think that the trees from which it comes have become extinct; while others think differently. In those countries where but few white men have penetrated, it is often found buried in earth where not a vestige of tree or shrub is to be found. This is accounted for by the trees having been in existence hundreds, perhaps thousands, of years since; and, having decayed and passed away, the matter they emitted in their youth and vigor lies buried around the roots, estimated to be thousands of years old. It is collected in this state, and shipped to this country. The greater part of it is brought to Salem, a few miles from Boston, where it undergoes the process of cleaning and assorting. The three principal kinds are called Zanzibar, Benguela, and Angola, taking their names from the different coasts they are imported from. Each of these different kinds is assorted into some five to ten grades, each according to brilliancy, color, purity, and size of the pieces; in *this* state it is sold to the merchants and manufacturers of Boston and other places. The surplus is exported to London, some of it to be returned to head quarters in a manufactured state. It is worth from 12 to 60 cents per lb., and it is the quality of the material used that regulates the price of the varnish. The poorer the quality of the stock used, the cheaper the varnish; so the reader will observe that it is no saving to buy varnish at twenty-five cents less per gallon, for the difference in quality may be four times that sum.

Those ingredients put together at the proper time are boiled, stirred, and go through all the complicated forms and processes requisite, till the desired results are obtained; it is then taken from the coppers and deposited in the cans in the refining-room, remains there several months, is

drawn off, and sent to the warehouse in the city, where it undergoes another refining process, and then is ready for sale. As far as Messrs. Stimson, Valentine & Co.'s factory is concerned, the facilities they have at command make it a model establishment, and enable them to compete successfully with all engaged in the business. They can make three hundred gallons per day, and their system of manufacturing is so perfect in all its branches that a uniform quality is a certain result; a *desideratum* of no small importance to both makers and consumers. The weight and measurement of every particle of stock used is kept account of, and each day's work kept entirely by itself. But a few words about the store.

Messrs. Stimson, Valentine & Co.'s store, No. 36 India street, Boston, is one of those mammoth establishments that would do honor to any city in the world; and for such buildings, American cities are becoming famous all over Europe, as they as far surpass the conventional ideas of the old school of builders, as the energy and progressive perseverance of the people of Yankeydom surpass the old fogyism of the last generation. The building is seven stories high. The ground floor, covering nearly one fourth of an acre, is occupied by the office, and all the heavier materials usually found in a paint-store, embracing a large stock of white lead and zinc, oils, turpentine, colors, &c.

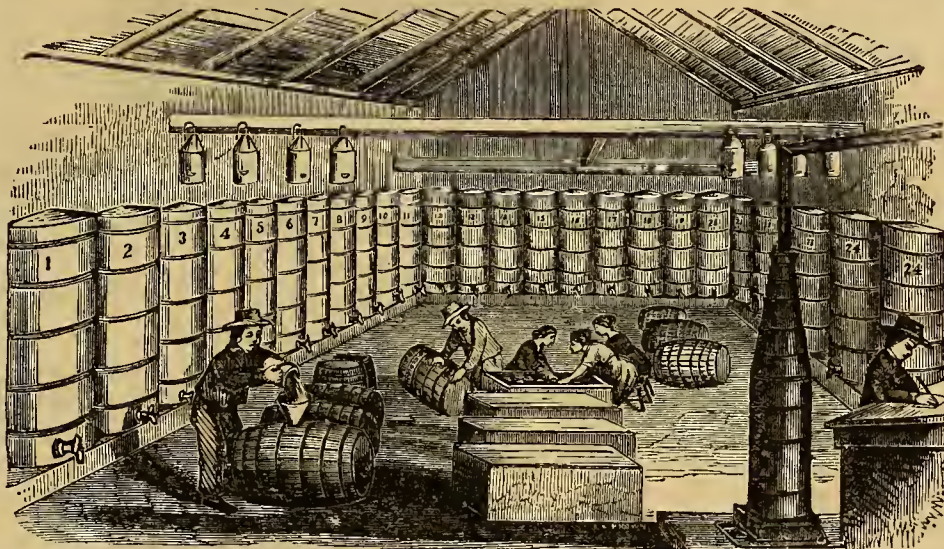

INTERIOR VIEW OF MESSRS. STIMSON, VALENTINE & CO.'S VARNISH-STORE.

The second story is exclusively used as the varnish-room, and is well worth a visit by all who wish to get posted on varnish, and who are not suited with the article they are using. The facilities this firm have, and the satisfactory explanations which they give the visitor of their mode of doing business, are convincing proofs to the minds of all who call and see for themselves. All varnish-makers know that the greatest obstacles they have to contend against are the whims and prejudices of painters. It is a common occurrence for one painter to reject a sample of varnish as worthless, and another painter to prize the same article as superior; but this firm have organized their business on such good systematic foundations, that they are enabled to suit the most fastidious tastes. This I can willingly bear testimony to myself. The first sample of their varnish I used, did not at all meet my wishes, I had many more objections, which I had only to mention to them, and the next lot was every thing I could wish for; the same has now been in wear two

years, and given the best of satisfaction both to myself and the owners of the vehicles it was used upon. In making varnish for undercoats the greatest object to be obtained is to have it rub well, flow freely, and be of a color that will do no harm to whatever it may be laid upon. This firm are fully alive to the importance of these points, and flatter themselves that they have succeeded in bringing their varnish for undercoats to this satisfactory state of perfection. A fact I can fully substantiate by my own experience. The system by which they govern and know the quality of their varnishes, is this: the date is taken when it is made, when brought to store, the number of gallons, number of the lot, price, quantity, quality, &c. of every ingredient used, which is all neatly recorded on a card attached to each can; those I noticed read thus: Can 8, lot 26; 265 gallons made March 12th, '58; transferred to store Aug. 21st, '59. Can 50, lot 268; 270 gallons made October 3d, '59; transferred to store February 1st, '60. And upon referring to the book kept for the purpose, the firm are enabled to see at a glance the ingredients used, and the alterations required to make the article acceptable, and in conformity with the wishes of any and every customer, whatever may be their opinions upon quality, and however hard they may be to please. The Messrs. Stimson, Valentine & Co. manufacture about

ten different grades of coach-varnish; and to contain and keep up this stock they have from five to eight cans of each kind, averaging from two to three hundred gallons each, these are drawn off in regular succession as sold; and as fast as one is empty it is replenished, and stands until the others are drawn off. Their catalogue contains twenty-two other different kinds of varnish, comprising every variety known to the trade, and suitable for every purpose and use that varnishes can be applied to.

The next story is mostly used as a refinery of bees-wax, which forms a large and important branch of their business. Wax from all parts of the world, even the newly opened country of Japan, may here be seen in its crude state, or manufactured into the various neat and tasteful forms in which it is sent into the market for sale.

The fourth floor is occupied by one of J. C. Hoadley's (Lawrence, Mass.) Portable Steam Engines. The same took the prize of the large gold medal at the fair of the American Institute, lately held in New York; it is a model machine, and shows the enterprising spirit in which the business of this firm is carried on. The benefits that accrue by having such a convenience as this machine upon the premises cannot be over-estimated. The whole store is heated by steam; and this is invaluable to the quality of the varnish. None but the initiated can properly appreciate the importance of keeping varnish at a uniform temperature; for when allowed to chill, and grow thick and heavy requiring heat before being used, it becomes tough and ropy, which is at once ascribed to the bad quality or the inability of the makers to manufacture good varnish; but by the aid of steam the varnish-room of this firm is kept at a uniform temperature all the time from month to month.

The engine also turns several mills for grinding lead, zinc, pumice-stone, &c., &c., and works one of Adam's Patent Elevators, by which cases of gum, casks of lead, oil, and other packages of greater or less weight are taken from the cellar to the seventh floor with dispatch.

The fifth story is used as a depot for whole packages of paints and colors; and the sixth, exclusively for gums of all grades and qualities.

The office is well worthy of a minute inspection, as it contains samples of every article manufactured by them. Samples of varnish may be seen on panels that have been exposed and tested in various ways. This firm take great pains to manufacture a good-drying, durable coach Japan, and their specimens are free of that fat, thick substance which is so much complained of by a majority of painters. To have good Japan in a carriage paint-shop is equally as desirable as to have good varnish.

The Messrs. Stimson, Valentine & Co. manufacture an imitation English varnish; and they have the good sense not to warrant it as durable as the true English itself; but the price (four dollars per gallon) is only about two thirds the price of the English varnish. I have remarked in another part of this magazine that the poorest article of English carriage-varnish sells for sixteen shillings (four dollars) per gallon, and I have no hesitation to assert that this varnish is far superior to any English carriage-varnish sold at a similar price. This varnish has an excellent body to it, and is warranted to give good satisfaction with reasonable durability.

This firm do a large business in the common grades of varnish; their "railroad-car varnish" is used on many of the great railroads, and by many is preferred to the best of English. Their piano polishing and flowing varnishes are extensively used all over the country. Their supply of stock and tools used by both house and carriage-painters is equal in quantity and quality to any other house in New England. An abundance of testimonials are shown to the visitor, all speaking highly of the quality of their varnishes, and a majority of these are from men that occupy the principal stations in the most noted carriage-shops of Boston, New Haven, and other places all over New England. This firm have every advantage over competition—the senior member having been engaged in the business nearly thirty years, and until they lately moved had been located in one store twenty-seven years, and that the oldest in New England in the trade; they are now reaping the fruits of a long and faithful service devoted to the interests and advantage of their numerous patrons. They deserve all their rewards; for they have spent a fortune in bringing their establishment to its present perfection, and the testimonials by which a generous public have rewarded and appreciated their exertions, must be very flattering to them.

Their medals and diplomas which they have received from mechanical, art, and other scientific institutions are some recompense for their past endeavors; but "Excelsior" is still their motto: their only ambition appears to be to make their establishment second to none in the country; and if a well-arranged factory, a perfect store, thirty years' practical experience, ample capital, persevering energy and liberality, and a strict attention to all business transacted by or through them, make a perfect establishment,—then Stimson, Valentine & Co. may certainly claim pre-eminence over most other houses engaged in their line of business.

My visit was so instructive to myself, that I shall take the liberty of inviting you, Mr. Editor, or any of your readers interested in this branch of our craft, to take the same pains that I did, and view the facilities this firm have for accomplishing all they undertake. For the kind invitation and the courtesies extended upon the occasion, they will please accept the thanks of their, and, Mr. Editor, Your, obedient servant,  
E. E.

## Trimming Room.

For the New York Coach-maker's Magazine.

### FANCY STITCHING PATTERN.

MR. EDITOR:—The accompanying design represents a pattern for a fancy-stitched oval piece of harness leather

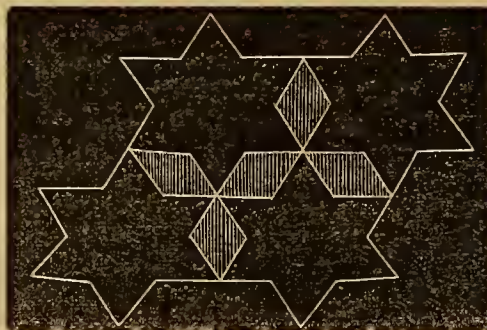

to put behind an oval, as in the buggy with the turn-over seat on plate XLIII. This makes a very pretty ornament in finishing various parts of buggies, rockaways, &c.; which I think will very soon become quite fashionable. W.

For the New York Coach-maker's Magazine.

### ROCKAWAY LAZY-BACK.

THIS illustration represents the lazy-back of a rockaway, as cut off at the joint of the hinge. The style is in the half

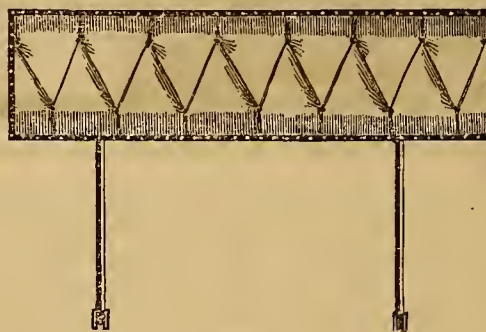

diamond fashion, pointed towards the sides of the back, around which it is tacked, and afterward covered and finished with seaming lace. There is nothing particularly new in the design, but it will no doubt prove useful to some of your numerous readers. W.

SUBSTITUTE FOR MOSS AND HAIR.—An article known as *pulu* has been introduced into the San Francisco market, which is reported to be fast taking the place of moss and hair for stuffing carriage-linings, cushions, mattresses, sofas, &c.

## The New York Coach-Maker's Magazine.

MAY 1, 1860.

E. M. STRATTON, Editor.

### TO READERS AND CORRESPONDENTS.

**RENEW YOUR SUBSCRIPTIONS.**—Our present subscribers will please bear in mind that our rule is to stop the Magazine when the year expires, unless they renew by sending us the payment IN ADVANCE. To secure a complete series, therefore, our friends will see the necessity of being prompt, for we intend to regulate our edition of the THIRD VOLUME as near the wants of the craft as is possible. Southern, Western, and Canadian money, or post-office stamps, will be received at par. Subscribers in the British Provinces must remit twenty-five cents extra, to prepay postage for the year.

**CAUTION.**—The great popularity of this Magazine, has led some unprincipled individuals to speculate in obtaining subscriptions without authority. The Publisher therefore gives notice that no receipt will be considered binding unless it has attached to it an engraved facsimile of his autograph. In all cases, see that agents have a good supply of the Mag., and can produce a certificate of their honesty, entirely in the publisher's handwriting. Our friends will confer a favor if they will give us early notice of suspected impostors.

**SPECIAL NOTICE.**—After this (with the publication of the June Number), the price of the monthly parts of this Magazine will be raised to 30 cents each, to such as purchase only by the single number. Subscriptions paid in advance, as heretofore, will remain on the same terms. This is done because those who subscribe to us are our main reliance, and we are determined to favor those who favor us, and because it is not fair to sell equally as low to monthly purchasers as to yearly subscribers paying in advance.

**AN AGENT'S LICENSE REVOKED.**—A person calling himself J. C. Brain, was some time ago introduced to us, and given an Agency on the Magazine; it was revoked on the 1st of March, and he is no longer an Agent, having broken his contract.

 All letters directed to this office on business, NOT relating to the Magazine, but solely for the writer's benefit, must inclose a stamp; if requiring an answer, two red stamps. Orders for a specimen number must be accompanied with nine three-cent stamps. When these terms are NOT complied with, no attention will be given them.

### A SQUINT AT THE FASHIONS IN AMERICAN AND EUROPEAN CARRIAGES.

SCARCELY anything need be said here by way of description, since an inspection of our monthly plates will give a far better idea of the prevailing American fashions than mere words could convey to the mind. Among the local influences in this vicinity upon the tastes of the fickle goddess, none have been more apparent than those brought about by that "institution" known as the Central Park, evidence of which can be had on any fine day by any one who will take the trouble to visit it. There, a correct American panorama of "Life on the Road," with a peep into Fifth Avenue, may be had; both at the same time. Evidence of the fact that Young America is "getting along" can no longer be disputed.

Among the more popular heavy carriages we might mention round-front Caleches, Bretts, Park Phaetons, Coupés, and an occasional type of the dog-cart. Our European readers will find from this catalogue that we in America have no lack of variety in our vehicles, in this respect "distancing" them completely. When we enu-

merate, in addition, the buggy family, they will see that they are "nowhere."

From a miniature collection of photographs, kindly sent us by the Messrs. Hooper & Co., Coach-Makers, Haymarket, London, we learn that the prevailing fashions in that city embrace the Bachelor's Brougham, Double Brougham on C springs, Sociable Landau on C springs, Town Barouche on C springs, Barouche Sociables and Wagonettes. In a future number we shall avail ourselves of their attentions by presenting our readers with a draft of the Bachelor's Brougham.

From Paris we learn that Landaus, Landauettes, Calèches, Prince Alberts, Coupés, and basket carriages of a new kind, are being extensively made. The *Mercure Universel* says, business is not very active there, nevertheless there is not any sensible stand-still, and if exportation had been as in former years, there would have been a lack of hands. From this, it is evident that business at home and abroad is improving.

The following remarks from our English cotemporary will be of some interest in this connection:—

"Although the past year has been marked by some important modifications in the art of carriage-building, we believe that the present style of manufacture is susceptible of great improvement. Considerable changes in fashion have been apparent for some time. The demand for Broughams has not been equal to that of previous years. The Sociable, Landau, and the Elcho have been the favorites. Barouches, wagonettes, driving-phaeton, and dog-carts have met with a fair share of patronage, and the prospects of the trade are good. The prosperity of the country, the vast influx of precious metals, the high prices of public securities, and the upward tendency of railway stock, have created such confidence, as to give an impetus to every kind of enterprise, both at home and abroad; and the sale of carriages, both for pleasure and for business, is likely to be more extensive in the present year. The exportation of carriages appears to us, from some cause or other, not to have been such as we have a right to expect, when we consider the excellence, durability, and finish of English carriages, as compared with those manufactured in any other part of the world; but it is a fact, that France exports more than double the number of carriages that we do. This ought to induce our builders and merchants to inquire into, and be determined to find out, the reason of the preference giving to French vehicles for the South American States, the Cape, and the Brazils, as these are the best export customers of the Parisian builders. It is not the price which induces this preference, as their charges are fully equal to ours, and their facilities of transport by no means so favorable. Our advantage in this respect alone ought to insure us a fair share of patronage from foreign importers of carriages."

## MISCELLANEOUS BUSINESS NOTICES.

**BOUND VOLS. OF THIS MAGAZINE.**—We have had bound up in muslin, gilt, a few sets of this work, which we will sell at the office for six dollars (by mail, postage paid, or express, for \$6 50), or either volume separate for three dollars and fifty cents. Vols. I. and II. embrace about three hundred and fifty illustrations (eighty of them original designs for carriages; twenty-four ornaments for painting; eight stitching plates, and four portraits), and four hundred and seventy-five pages of letter-press matter of a standard character in almost every department of the Coach-maker's Art; most of it never before published. The work will be sent by express to order, price payable on delivery, where persons receiving it are willing to pay the costs of collecting the bills, in addition to that charged for the volumes.

Subscribers can have their numbers bound at this office for 75 cents in our uniform binding. Covers for the same can also be had (they cannot be sent by mail) for 44 cents, in which any binder can secure your *Magazines* uniform with those we sell, for a small sum. Where a club (or several subscribers in a place) will send their numbers by express to us, they will find that a convenient and saving operation for them.

**THE MAGAZINE IN NUMBERS.**—Those who have lost any part of their numbers can have their sets completed at 27 cents each (by mail, in stamps), or at the office at 25 cents. When we are called on to send a *specimen copy*, we expect to receive its value before it can be sent, and should the individual afterwards subscribe, the amount paid will be deducted. Our work differs from the ordinary class of publications in value, and since nine out of ten who *beg* for these "specimens," only have the curiosity to see the work, with no serious intentions of subscribing, we pronounce the game about "played out," now.

**THE USEFULNESS OF THIS WORK.**—There can no longer be any question raised as to the usefulness of such a *Magazine* as ours. The finest carriage we have seen for a long season, was shown us on our late visit to Philadelphia, and which the manufacturer admitted was built after one of Mr. Irving's original designs. Another evidence of its usefulness may be gathered from the circumstance that many of our Western friends complain that our designs are too fine, and are not fashionable in their section of country. Well, we have always thought that the value of all teaching consists in advancing something *new*. We would suggest (aside) to such as have complained of our advance in fashion, that they get ahead of their neighbors in this respect, and ahead of them in custom, too, by getting up a better class of work. *Good work, of good design*, will always sell the best.

**THE PROFIT IN TAKING THIS WORK.**—How many carriage-trimmers have spent several days in trying to originate something novel in a design for stitching-plates, and yet after all find they have but an indifferent pattern when it is put on their job. For the small sum of *three dollars* we will furnish better designs—enough to supply you for an entire year—of a superior order. The painter will find on our ornamental plates such designs as he may look for in vain anywhere else. Any man who reasons at all, will soon see where his true interest lies, and not hesitate about sending in his subscription at once, and thereby secure a monthly visitor, which should it only *suggest* one new idea to his mind during the year, yet must and will be worth more than three dollars to him.

**THE MAGAZINE AS A PRESENT TO EMPLOYEES.**—Bosses will find that where they have apprentices, our *Magazine* as a present to them, would repay more than fifty per cent. on the outlay it costs them. They will find that (unless the boy is very ungrateful) he will do more work, and do it more cheerfully, too, in consideration of his boss having done so. Try it, and let us know the result. We know of cases where a dealer in carriage trimmings has invested a few dollars in *Magazines* and sent them to his customers (carriage-makers) as presents with advantageous results. No better reminder of their obligations to the donor, could be employed.

**CLUBS FOR THE MAGAZINE.**—Have we not some kind friend, in every shop of the land, who will with pencil and paper, and a *little perseverance*, go through it and get us up a club, and at the same time benefit themselves and us. See what we promise such on the first page of the cover. Do not wait for our agent to visit your shop and then expect him to assist you in what we pay him to do, and then expect to get your copy "*free gratis for nothing*." It "can't be did;" because we cannot afford it. You, at \$2 in a club, only pay us the first costs of production, and were it not for *our* advertising friends, you would not get it at any price, long. Only *voluntary* club agents have any legal claim on us, and such only can claim our professed rewards.

One of the principal objects in starting this work was, to show to the world that Coach-makers were capable of exhibiting as high a standard of literary merit as any other class of men. We flatter ourselves with the belief that our object has in some measure been crowned with success. Col. Forney (a good witness) of the *Philadelphia Press*, says, in referring to our biography of Mr. Wm. D. Rogers, of that city: "We shall respect the coach-makers more than ever for having such a *Magazine* as this." We could, were it necessary, bring forward the testimony of many other editors to prove our *Magazine* a good one.

HOW TO REMIT MONEY.—Where Eastern money cannot easily be obtained, Southern, Western, and Canadian money will be received at par. Where the sum is large, however, drafts on New York are preferred. For the change, *never* send a higher denomination of stamp than 3 cents, as we have no use for larger ones. It will cost you only 5 cents to *have your money letters registered*, and to do so insures safety. In sending gold coin, be particularly careful to *paste* them securely between two pieces of paper, otherwise they will be liable to shake out and be lost from your letter. It is a very careless way of doing business to merely fasten gold to the letter with wafers; they are sure to get loose before reaching their destination. Lastly, be very careful and prepay the postage on your letter, and direct it in a plain hand to E. M. STRATTON, No. 106 Elizabeth street, New York city.

A WORD TO OUR "REAL GENUINE" FRIENDS.—There are hundreds who are constantly calling upon the coach-making fraternity with their new inventions appertaining to the business, who with a word from the well-wishers to our enterprise—suitably put in—might induce them to advertise with us, and so benefit all parties. Those who will try it shall have our best thanks. See our terms on the cover.

#### LETTER FROM NEW HAVEN.

EDITOR COACH-MAKER'S MAGAZINE:—*Dear Sir.*—In accordance with my former promises to you that while traveling over the dominions of our respected Uncle Sam, I would give you from time to time, my experience as a traveling carriage maker, and the items of interest I might pick up beneficiary to the craft, as well as the little scraps of fun falling in my way, which would amuse, if not instruct the whole brotherhood, (to use a Yankee expression peculiar to the land of steady habits and pumpkin pies,) I take my pen in hand to address you these few lines, it, in my opinion, (*I am a Yankee myself*,) being a libel upon the Yankee character on the part of those who say that the aforesaid Yankees in the good old State of Connecticut, manufacture bass-wood hams, wooden nutmegs, horn gun-flints, and eight-day clocks which run only long enough for the itinerant merchant to get out of sight of the purchaser.

While in the State of Georgia, where many, very many carriages of Connecticut manufacture are annually consumed, I fell in with an old friend whom I shall here call Mr. Rollin, who is continually traveling for one of the heaviest commission houses in New York, soliciting consignments to them; who after the usual greetings, took me by the arm and told me in a good Yankee dialect, "Now look a-here, Dilks, the first place we must go, is to see S. L. Williams, an old friend of both of us, who is right here in this town, permanently located." Well, to S. L. W. we went, and found him looking well. After the usual congratulations, compliments, &c., my friend Rollin says: "Dilks, Williams here is an ex-carriage foreman, manager and book keeper as you know, from one of the New-Haven houses, and I must tell you a little cir-

cumstance which happened to him after he arrived here in Georgia, which will show you how little carriage-makers know about riding in carriages, even if they make them or superintend the making of them themselves.

"Well," Rollins goes on to say, "Williams and myself not having much to do, and hearing of a scrub race coming off some three miles out of town, negotiated with a livery-stable keeper for a horse and no-top buggy, to tote us (as a negro would say) to the race course; and when some half the distance had been accomplished, we came to the foot of quite a steep hill, at the bottom of which was a drain or sluice-way, running across the road, and covered by a bridge of logs. The contents of the aforesaid drain being composed of the sewerage from a slaughter-house, some half dozen pig-pens, a barn yard, and also from a miniature tan-yard above the road. The aforesaid ingredients constituted a mass of the consistency of tar or molasses, but owing to the age of the bridge and the heavy loaded teams passing over it, the logs had been carried down the muddy stream, and we had to drive through or rather ford it. Our horse being a fast one, and as Rollins says (taking his word for it), being an indifferent horseman, went *rather* strong through the aforesaid mud-hole, and when we reached the abutment of the bridge on the opposite side, we brought up all standing. Having a firm hold of the ribbons, I preserved my equilibrium; but not so my friend Williams. There being no back above the seat to the buggy, Williams turned a complete somerset (emulating the circus performers) backwards, and disappeared under the mud and slush! I pulled up as soon as I could, and turning around, saw my friend picking himself out of the aforesaid compound, covered completely with it, and of one color, viz: a shining black. I, notwithstanding I felt inclined to laugh, with as much of a sympathetic tone as I could command, asked him if he was hurt. Spluttering and blowing the filthy compound from his mouth, and wiping it as best he could from his eyes, he stammered forth. "I'm stumped Rollins, if this ain't an episode in a man's life." We went a round about way into town, and lost the fun and excitement of the race for that day.

After again having reached the good old State of carriage-makers, business called me to its northern frontier, or the line of the State of Massachusetts, where I saw one of the most extraordinary cases of *cousining* that has ever fallen under my observation, while residing in Connecticut, and which I will now attempt to describe. To begin; the carriage-maker with whom I was negotiating, being a young man and married only some three years, pleasantly situated, and having a lovely wife, invited me to make his house my home; and as the hotel in the place was an indifferent one, I gladly accepted his offer. While occupied in the afternoon with my friend P., a tall overgrown specimen of the *genus homo*, entered and said: "*How d'ye do*," "How do you do, Sir!" says P. (quite a pause.) When P. again addresses him. "Well, Sir, what can I do for you, anything in the carriage way to-day Sir?" "Oh, no," says the stranger, or "cousin" as I will now call him. "I come *down* to W. to-day to sell a horse, and I thought being as *I'd* hearn of your wife, *I'd* come in here and see you and her, and cousin a bit. *Doin'* a great deal of business, ain't you; don't mind me, "*I'll make myself to hum.*" My friend P. says, "You see I am very busy now, my house is just down on the next corner, and if you will step down you will find Mrs. P. at

home no doubt, and she will entertain you." "Wall," says cousin, "I guess I'll step daown and see her. You see Mr. P. I am a goin to marry your wife's second cousin, and I'd thought I'd come daown and get acquainted, kinder, with her relations; I'll be to your house to tea to-night." With which announcement cousin left us to complete our business.

When supper-time came, P. and myself left the manufactory for his house, and found "cousin" domiciled all right, as much at home as if he was an own brother of P.'s. Mrs. P., who is the most hospitable lady, by-the-by, I have ever met with, gave me the items of his introduction (by himself, however) into the house. Herself, in company with a sister of Mr. P.'s, had been out making calls, and the house was left in charge of the servant. A loud knock at the door was answered by the servant; and on opening it our cousin presented himself, saying, "*ho dew-do* cousin P." The servant answered his salutation by telling him Mrs. P. was not at home. "Wall," says *cousin*, "I thought you was cousin P.; wall, when will she be *hum*?" On being answered that Mrs. P. was soon expected, he says, "Wall, I guess I'll come in and wait for her." Soon after Mrs. P. arrived, and found an entire stranger to her, to use Mrs. P.'s language, waiting in the parlor, where he had been seated by the servant, who introduced himself as Mr. Josiah L. Blatt, who (if he was not then) "would be soon a cousin of hern, as he was agoin to marry her cousin James Baldwin's daughter, Jerusha." "You remember Jerusha, don't you, cousin P.?" says our cousin.

Friend P. remarked to me, that it was the most severe case of cousining he had ever seen on record; but owing to the peculiar circumstances he had nothing to say, and would entertain him as best as he could; and accept as full pay for supper, lodging, and breakfast from his cousin in embryo one tenth of his stock of brass and impudence, if it could only be transferred to him. Our cousin, after partaking of a bountiful breakfast next morning, bid us all good-by, and invited us all to come up and see him.

So much for so much. Now having done with nonsense let me, if it is possible for me to do so, talk a little sense. In my travels, no matter in what part of the country I may happen to be, I find a universal complaining among all the carriage-dealers, that apparently no two counties in the same State have the same width of track; varying, as in the State of Connecticut from four feet four inches to five feet four inches; being in New Haven county one width, in an adjoining county another. Now, I must say, I am of the opinion of one of our best, and oldest carriage-makers in this city of Elms, viz., that if the representatives in the national congress, now assembled, would pass a law, establishing one standard width of track—whether the same be four, five, or six feet wide, only let them, the congress, as aforesaid, pass this one edict, and then disband, dissolve, and adjourn without date—they, the members, would be doing the whole universal country a signal service, and much oblige the whole fraternity of carriage-makers. In accordance with his idea, I have thought best to give you his ideas upon the subject; and pray you to place the same before your readers. And as a standard track for all the States would be of great benefit, and pecuniary profit to all carriage-manufacturers and dealers, as well as consumers, we beg you to urge, and advocate the same, and as in duty bound your humble petitioner will ever pray.

Respectfully,

A. C. MAKER.

## PROSPECTUS OF THE THIRD VOLUME.

THE ONLY WORK OF THE KIND IN AMERICA!

ON THE 10TH OF MAY, 1860, WILL BE PUBLISHED  
No. 1, VOLUME 3, FOR JUNE,

OF THE

New York Coach Maker's Monthly

MAGAZINE;

DEVOTED TO THE LITERARY, SOCIAL, AND MECHANICAL INTERESTS OF THE CRAFT;

Embracing, monthly, four plates of designs (mostly original) for carriages, ornamental painting, stitching and carving, with an occasional portrait of some distinguished coach-maker, printed in tints; twenty pages of letter-press finely illustrated with numerous engravings on wood; several advertising pages worthy the attention of coach-makers, and a cover; the whole being printed in the best style of the art on very fine paper, presenting to the Craft the most useful and interesting Magazine ever offered to any branch of mechanical science.

WHEN we originated this Monthly two years ago, we did so with many doubts and fears as to its ultimate success; but, no sooner had our first prospectus gone abroad, than did the response to it in the form of subscriptions, and other evidences of regard, assure us that we had made a start in the right direction. That such a publication as ours is needed, we have sufficient evidence in the steady increase of patronage we have received from the beginning until now. The friends of correct business principles have nobly interested themselves in our behalf, and to-day we feel an honest pride in being enabled to say that among our well wishers we number the most noble-minded men to be found in a civilized community.

We have been told that we have more than redeemed our promises in the past. Will it be asking too much when we invite the confidence of the public in our enterprise on entering upon the third year? We think that our arrangements now are of a nature so complete, that we shall be able to meet every reasonable expectation of the craft, and make our third volume the best we have yet issued.

The general plan of the volume for the third year will not differ materially from those that have preceded it. We shall by constant observation and unceasing toil in the field of Mechanics and Literature strive to render it a useful companion in the work-shop of the coach-maker, and a welcome visitor to his home-circle. We think it unnecessary to give in this connection the certificates appended to the first and second volumes, as we are now well known throughout the country for integrity, and a will for doing that which is right.

Our terms will remain unchanged, according to the following plan:—

#### TERMS OF SUBSCRIPTION:

Single copies, \$3.00 per year; three copies, \$8.00; six copies, \$15.00; eight copies, \$20.00; ten copies, \$25.00. Letters ordering specimen copies must inclose 25 cents. Each Canadian subscriber must send 25 cents extra, to prepay his yearly postage. Payments must be made invariably in advance. All Clubs must be sent to one address, except on removal of one of the parties, when the letter ordering a change must inclose a red stamp.

Any individual voluntarily forming a club of eight subscribers, and forwarding us \$15, shall have a ninth copy for his trouble. If ten or more, he will be entitled to a bound volume at the end of the year. Any person sending \$3.00 shall have the first, second, and third volumes in numbers. For either volume, bound in muslin, gilt, single, \$3.50; the first and second volumes together, \$6.50.









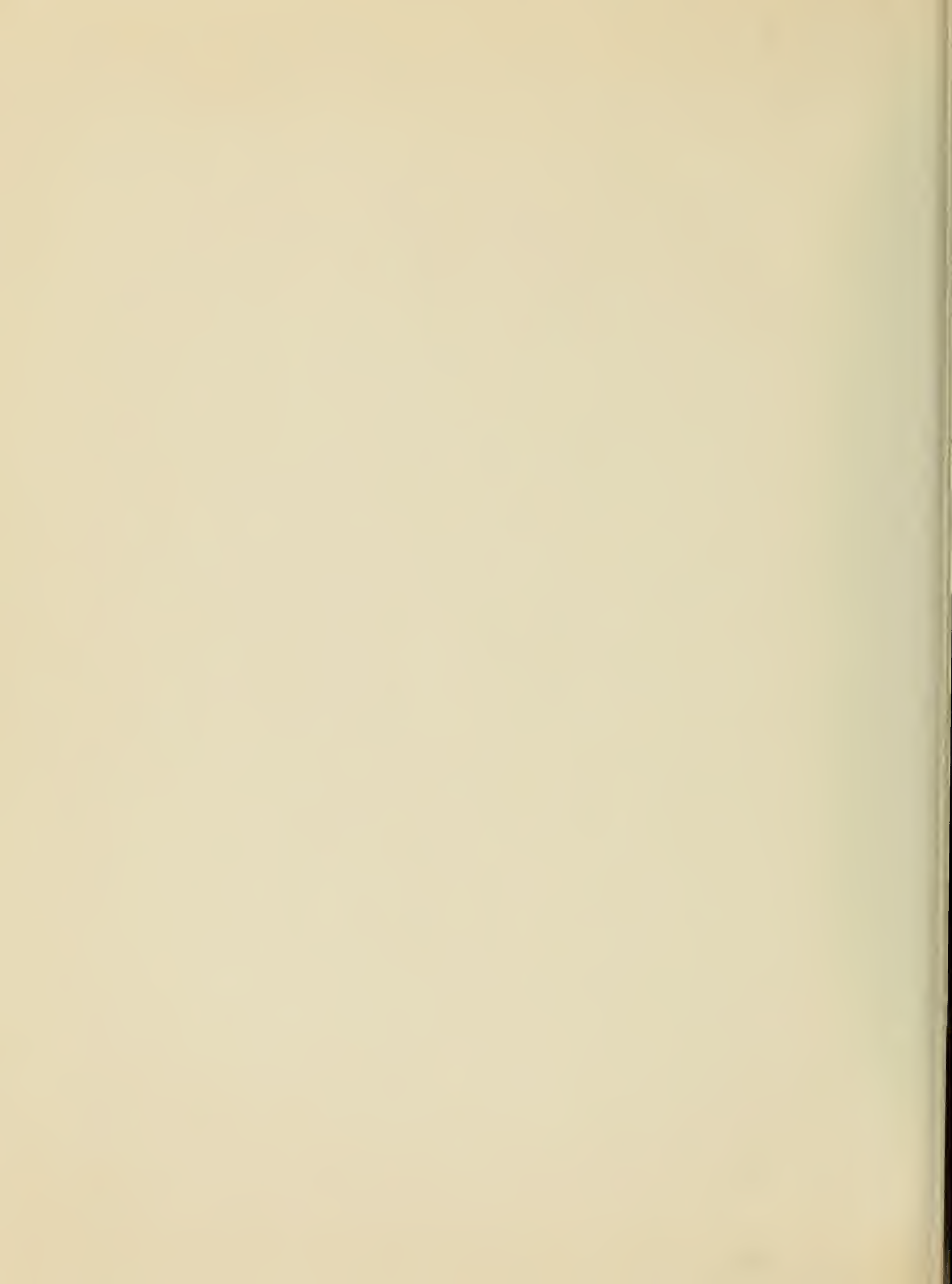



SMITHSONIAN INSTITUTION LIBRARIES



3 9088 01548 7689